

2016 Price List

Updated September 2016



BUSH BUSINESS FURNITURE



Federal Supply Service-Authorized Federal Supply Schedule Price List Online access to contract ordering information, terms and conditions, up-to-date pricing, and the option to create an electronic delivery order are available through GSA Advantage!, a menu-driven database system.

The Internet address for GSA Advantage! is: GSAAdvantage.gov • Worldwide Federal Supply Schedule Contract for Schedule 71, Part 1- Office Furniture
FSC Groups 7105, 7110, 7125, 7195 Contract No. GS-28F-0040V • Contract Period: July 24, 2009 through July 23, 2019

Contractor: Bush Industries Federal Government Sales • One Mason Drive, PO Box 460 • Jamestown, NY • 14702-0460 • Phone: 1-888-339-2202 • Fax: 1-716-665-1111

Email Address: GSAServices@BushIndustries.com • <http://www.bbffits.com/Markets/GSA.aspx>

Business Size: Small • For more information on ordering from Federal Supply Schedules click on the FSS Schedules button at fss.gsa.gov.

What you need.

Our **total turnkey solution** has everything you need for hassle-free furniture buying. With the right products and services, we ensure you get great furniture **fast, easily, and affordably.**

.....



Where you need it.

Across the street or across the country, we specialize in small orders and fast turnarounds to **remote locations at the same flat rate.**

.....



When you need it.

Ready to ship within 24 hours of order receipt, delivered to your dock in 5 business days, **installed nationwide within 10 business days***.

*remote locations may take longer



Table of Contents

| | |
|--|---------|
| Terms and Conditions | 4-5 |
| Warranty Information | 6-7 |
| Momentum | 8-13 |
| Milano2 | 14-19 |
| Quantum™ | 20-25 |
| Realize™ | 26-37 |
| Enterprise | 38-41 |
| Syndicate | 42-45 |
| Series C Elite | 46-62 |
| Series C | 63-71 |
| Series A | 72-79 |
| Easy Office™ | 80-83 |
| Office in an Hour | 84-85 |
| Venture | 86-87 |
| Privacy Screens | 88-89 |
| ProPanels | 90-93 |
| Seating | 94-96 |
| BBF Bookcases | 97-98 |
| Height Adjustable Standing Desks | 99-103 |
| Conference Tables | 104-107 |
| Accessories | 108-113 |
| Metal Filing | 114-115 |
| Envoy | 116-117 |
| Northfield | 118-119 |
| Saratoga | 120-121 |
| GSA Terms and Conditions | 122-123 |

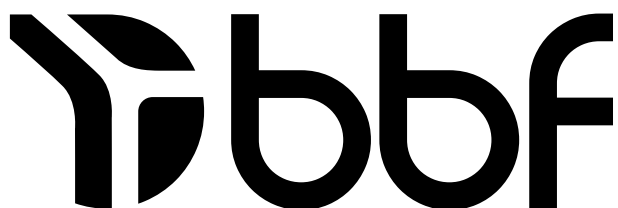
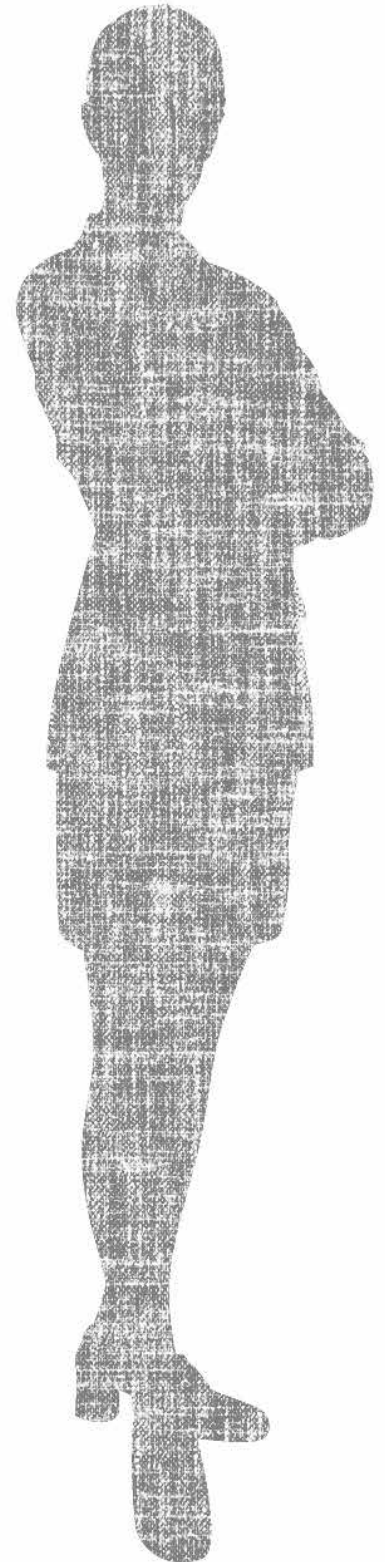

BUSH BUSINESS FURNITURE

TERMS AND CONDITIONS

Pricing

- Prices shown are manufacturer's list price at time of printing.
- Prices are subject to change without notice.
- All prices shown are in US dollars.

Install 360™ Service

Install 360™ pricing includes furniture delivery, assembly, installation, final adjustments to ensure optimal product performance, dusting, leveling and package removal – all in a single visit. Pricing for Install 360™ is individually quoted – please call 800-964-1638 for a price quote.



GSA Pricing:

- Products that are approved to be sold on our GSA contract are indicated throughout the price list with the following symbol. 
- Products without the symbol are not on contract.
- Pricing is based on approved list pricing by the GSA.
- Product eligibility and pricing is subject to change.
- Please see pages 122-123 for additional terms and conditions regarding our GSA contract.

Pre-Order Support

Space Planning:

BBF offers a free space planning service. Install 360™ orders of more than 25 pieces require a completed space plan before an order can be processed. Contact BBF Space Planning at 800-964-1638, or email spaceplanning@bushindustries.com for assistance.

Order Processing

Order Receipt:

Order is transmitted to BBF in writing (preferably electronically) by Dealer. Dealer is responsible for providing correct model numbers by finish, requested delivery method, pricing and ship-to information when placing an order.

Orders can be accepted electronically through EDI; CSV flat file (Excel); by email to bbfsales@bushindustries.com or faxed to 716-665-1111.

New customers must also submit a credit application and signed BBF Dealer Agreement before an order can be accepted.

- Next-day shipping terms apply to orders received electronically (EDI or CSV Flat File.)
- Additional processing time may be required for orders not received electronically.
- Orders received after 12pm (ET) are considered received next business day.

Customer Service/Sales Support:

Please call 800-964-1638 for assistance with questions regarding order processing, product availability and general product information. Office hours are Monday–Friday, 8 am–5 pm ET excluding all major holidays.

Shipping:

Most STANDARD orders deliver within 3–5 business days from receipt of order. (Remote locations may take longer.) Most Install 360™ orders deliver within 10 business days. Orders are invoiced at the time of shipment; See BBF Dealer Agreement for complete terms of sale.

Post-Sale Support

Return Policy:

A return authorization is required – Contact BBF Support at 800-964-1638 or email bbfsales@bushindustries.com to get authorization. BBF cannot accept returns or issue credit without prior authorization. See BBF Dealer Agreement for complete terms and conditions.

Warranty Policy:

For all issues related to post-sale service such as parts replacement, warranty claims and assembly tips, please call Consumer Service 800-950-4782 or email consumerservice@bushindustries.com, Monday–Friday, 8:30 am–7:30 pm ET.

LIMITED LIFETIME WARRANTY

Bush Industries promises to repair or replace any Bush brand product or component that is defective in material or workmanship for as long as you, the original purchaser, own it. This warranty is subject to the limitations, exclusions, and other provisions below. It applies to products manufactured after January 1, 2007.

The materials and components listed below are covered according to the following schedule from the date of sale:

- Five Years – Glides, casters, polymer-based components, panels, upholstery fabrics, foam, laminates, veneer finishes, and other covering materials.
- Three Years – Height Adjustable Standing Desk Bases

Exclusions:

This warranty does not apply and no other warranty applies to:

- Normal wear and tear, which are to be expected over the course of ownership.
- Damage caused by the carrier in-transit, which will be handled under separate terms.
- Modifications or attachments to the product that are not approved by Bush Industries.
- Products that were not installed, used, or maintained in accordance with product installations and warnings.
- Products used for rental purposes.
- Products used outdoors.

TO THE EXTENT PERMITTED BY LAW, BUSH INDUSTRIES MAKES NO OTHER WARRANTY, EITHER EXPRESS, STATUTORY OR IMPLIED, INCLUDING ANY WARRANTY OF MERCHANTABILITY OR FITNESS FOR A PARTICULAR PURPOSE. IF BUSH INDUSTRIES CANNOT LAWFULLY DISCLAIM ANY STATUTORY OR IMPLIED WARRANTIES THEN TO THE EXTENT PERMITTED BY LAW, ALL SUCH WARRANTIES SHALL BE LIMITED IN DURATION TO THE DURATION OF THE WARRANTY SPECIFIED FOR THE COVERED PRODUCT OR COMPONENT. BUSH INDUSTRIES WILL NOT BE LIABLE FOR ANY CONSEQUENTIAL OR INCIDENTAL DAMAGES.

Notice to purchasers for home or personal use: federal law does not permit the exclusion of certain implied warranties for consumer products. Therefore, if you are purchasing this product for home or personal use, the exclusion of implied warranties noted in the above paragraph does not apply to you. Some states do not allow the exclusion or limitation of incidental or consequential damages, so the above limitations or exclusions may not apply to you. This warranty gives you specific legal rights, and you may also have other rights which vary from state to state. This warranty applies only to products sold within the United States of America and the Commonwealth of Canada. To obtain service under this warranty:

Your Bush dealer is our mutual partner in supporting your warranty requests. By following the procedures outlined below, you can be assured of the best level of service.

1. Contact Bush Industries, Inc. within 30 days of discovery of the defect. Be prepared to affirm you are the original purchaser of the product and to provide the item number(s) for the product in question.
2. Bush Industries affirms that the product in question is eligible under the conditions of warranty stated above; the customer service representative or another representative of the Company will determine whether to provide replacement parts, authorize repairs, or replace the product. This warranty is intended to comply with the Magnuson Moss Warranty-Federal Trade Commission Improvements Act, and any provisions of this warranty or actions taken by Bush Industries pursuant to this warranty shall be construed in accordance with such act.



TEN-YEAR COMMERCIAL WARRANTY

All Bush Industries office furniture products marketed under the Bush Business Furniture brand are warranted to the original purchaser at the time of purchase and for a period of ten years thereafter. We warrant to you, the original purchaser, that our commercial-quality furniture and all its parts and components are free of defects in material or workmanship. "Defects," as used in this warranty, are defined as any imperfections which impair the use of the furniture product.

Our warranty is expressly limited to the replacement of furniture parts and components. For ten years after the date of purchase, Bush Industries will replace any part described on the Furniture Parts List that is defective in material or workmanship. This warranty applies under conditions of normal use. Our Bush Business Furniture products are not intended for outdoor use.

This warranty does not cover:

- 1) defects caused by improper assembly or disassembly;
- 2) defects occurring after purchase due to product modification; intentional damage, accident, misuse, abuse, negligence or exposure to the elements; and
- 3) labor or assembly costs.

IMPLIED WARRANTIES, INCLUDING THE WARRANTY OF MERCHANTABILITY, SHALL NOT EXTEND BEYOND THE DURATION OF THE WRITTEN WARRANTY STATED ABOVE, AND IN NO EVENT SHALL BUSH INDUSTRIES BE LIABLE FOR INCIDENTAL OR CONSEQUENTIAL DAMAGES RESULTING FROM USE OF THE PRODUCT.

Some states do not allow a limitation on how long an implied warranty lasts or the exclusion or limitation of incidental or consequential damages, so the above limitation and exclusion may not apply to you.

IMPORTANT REMINDER: Please fill out and return your Product Registration Card promptly. Although not required, it will help us serve you even better in the future. This warranty gives you specific legal rights. You may also have other rights that may vary from state to state.

This warranty is intended to comply with the Magnuson Moss Warranty-Federal Trade Commission Improvements Act, and any provisions of this warranty or actions taken by Bush Industries pursuant to this warranty shall be construed in accordance with such act.

10-Year
Manufacturer's
Warranty

FIVE-YEAR COMMERCIAL WARRANTY

All Bush Industries office furniture products marketed under the Bush Business Furniture brand are warranted to the original purchaser at the time of purchase and for a period of five years thereafter. We warrant to you, the original purchaser, that our commercial-quality furniture and all its parts and components are free of defects in material or workmanship. "Defects," as used in this warranty, are defined as any imperfections which impair the use of the furniture product.

Our warranty is expressly limited to the replacement of furniture parts and components. For five years after the date of purchase, Bush Industries will replace any part described on the Furniture Parts List that is defective in material or workmanship. This warranty applies under conditions of normal use. Our Bush Business Furniture products are not intended for outdoor use.

This warranty does not cover:

- 1) defects caused by improper assembly or disassembly;
- 2) defects occurring after purchase due to product modification; intentional damage, accident, misuse, abuse, negligence or exposure to the elements; and
- 3) labor or assembly costs.

IMPLIED WARRANTIES, INCLUDING THE WARRANTY OF MERCHANTABILITY, SHALL NOT EXTEND BEYOND THE DURATION OF THE WRITTEN WARRANTY STATED ABOVE, AND IN NO EVENT SHALL BUSH INDUSTRIES BE LIABLE FOR INCIDENTAL OR CONSEQUENTIAL DAMAGES RESULTING FROM USE OF THE PRODUCT.

Some states do not allow a limitation on how long an implied warranty lasts or the exclusion or limitation of incidental or consequential damages, so the above limitation and exclusion may not apply to you.

IMPORTANT REMINDER: Please fill out and return your Product Registration Card promptly. Although not required, it will help us serve you even better in the future. This warranty gives you specific legal rights. You may also have other rights that may vary from state to state.

This warranty is intended to comply with the Magnuson Moss Warranty-Federal Trade Commission Improvements Act, and any provisions of this warranty or actions taken by Bush Industries pursuant to this warranty shall be construed in accordance with such act.

5-Year
Manufacturer's
Warranty

Momentum



Limited
Lifetime
Warranty

Momentum – Work Surfaces

- Constructed with 100% thermally fused laminate for durability and superior resistance to scratches and stains
- Metal-to-metal connections allow easy assembly and reconfiguration
- Durable edge banding protects against dents
- Metal support bar under surface helps ensure structural rigidity
- Pre-drilled to accept Keyboard Trays in multiple positions

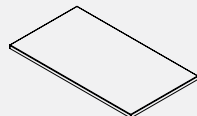
| | Description | Finish | SKU Number | Shpg Wt. (lbs) | Cube (ft.) | UPS/ Fed Ex | List Price |
|---|---|-------------------------------|------------------------|----------------|------------|-------------|------------|
|  | <p>72W x 30D Work Surface</p> <ul style="list-style-type: none"> • Accepts Articulating Keyboard Trays AC99801 and AC99889 • 71.54"W x 29.45"D x 1"H • Not on GSA Contract | Natural Maple Mocha Cherry | 34W72AC 34W72MR | 71 | 4.1 | Yes | \$455.00 |
|  | <p>60W x 30D Work Surface</p> <ul style="list-style-type: none"> • Accepts Articulating Keyboard Trays AC99801 and AC99889 • 59.53"W x 29.45"D x 1"H • Not on GSA Contract | Natural Maple Mocha Cherry | 34W60AC 34W60MR | 60 | 3.5 | Yes | \$425.00 |
|  | <p>42W x 24D Bridge</p> <ul style="list-style-type: none"> • Attaches to any work surfaces as a Bridge to create a U-configuration • 41.61"W x 23.15"D x 1.98"H • Not on GSA Contract | Natural Maple Mocha Cherry | 34RET42AC 34RET42MR | 37 | 2.6 | Yes | \$305.00 |

Momentum – Leg Kits

- ☑ Sturdy 60mm x 25mm welded steel tube construction
- ☑ Durable powder coat finish
- ☑ Adjustable levelers compensate for uneven floors
- ☑ All hardware and an assembly tool are included
- ☑ Pre-packaged in complete kit for easy ordering
- ☑ Accepts Glass Modesty Panel (tool included)

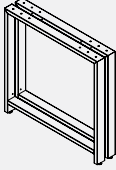
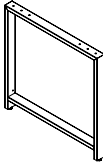
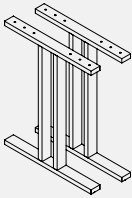

| | Description | Finish | SKU Number | Shpg Wt. (lbs) | Cube (ft.) | UPS/ Fed Ex | List Price |
|--|--|--------|--------------|----------------|------------|-------------|------------|
|  | <p>Leg Kit–Freestanding Rectangular Desk</p> <ul style="list-style-type: none"> • To be used with Rectangular Work Surfaces only • Accepts Leg Panel Insert • 4.72"W x 29.13"D x 28.53"H • Not on GSA Contract | Silver | 342OLEGSV-03 | 43 | 3.9 | Yes | \$302.00 |
|  | <p>Leg Kit–Rectangular Desk for 30H Storage</p> <ul style="list-style-type: none"> • Only to be used with any 30H Storage or File • Accepts Leg Panel Insert • 2.36"W x 29.13"D x 28.53"H • Not on GSA Contract | Silver | 341OLEGSV-03 | 22 | 2.5 | Yes | \$164.00 |
|  | <p>Leg Kit–Freestanding Dog-Leg Desk</p> <ul style="list-style-type: none"> • To be used with Dog-Leg Work Surfaces only • 4.72"W x 22.83"D x 28.53"H • Not on GSA Contract | Silver | 342TLEGSV-03 | 34 | 3.2 | Yes | \$325.00 |

Momentum – Tackboards

| | Description | Finish | SKU Number | Shpg Wt. (lbs) | Cube (ft.) | UPS/ Fed Ex | List Price |
|---|---|-------------------------------------|--|----------------|------------|-------------|------------|
|  | <p>72W Tackboard</p> <ul style="list-style-type: none"> • Tackable surface for posting messages, etc. • Fits on Back Panel of 72W Hutches • Available in four vibrant fabrics • 66.22"W x .51"D x 18.03"H •  (SIN 711-2) | Lime Smoke Tangerine Latte | 34TB2GN 34TB2GY 34TB2OR 34TB2TA | 14 | 1.7 | Yes | \$193.00 |



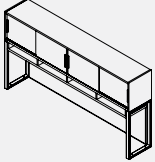

Momentum – Hutch Storage

- Door and drawer hardware constructed of extruded clear anodized aluminum
- Includes open work-in-process compartments to help organize papers
- Sliding door compartments accommodate reference storage
- All Hutches mount using commercial grade double-sided tape
- Max height of Hutch on a Work Surface is 72" floor to top



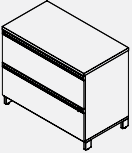

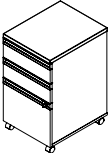
| | Description | Finish | SKU Number | Shpg Wt. (lbs) | Cube (ft.) | UPS/ Fed Ex | List Price |
|---|--|-------------------------------|--------------------|----------------|------------|-------------|------------|
|  | <p>72W Hutch with Doors</p> <ul style="list-style-type: none"> • Includes full back panel, which can accept 72W Tackboard • Can mount directly on work surface, or span two storage units • Comes with one Storage Connector accessory to connect two storage units together • 70.87"W x 12.99"D x 38.07"H •  (SIN 711-2) | Natural Maple Mocha Cherry | 34H72AC 34H72MR | 158 | 17.8 | No | \$1,083.00 |

Momentum – Storage

- File drawers accommodate legal, letter and A4 file sizes and include hanging file management system
- File drawers utilize full-extension, ball-bearing slides
- Box drawers utilize 3/4-extension, ball-bearing slides
- Drawer hardware constructed of extruded aluminum
- All Work Surfaces are constructed of 100% thermally fused laminate to resist stains and abrasions
- Adjustable levelers compensate for uneven floors
- Four wire management grommets included, (except Mobile Pedestal)
- All storage elements ship fully assembled from the factory
- All drawer locks are keyed alike (contact BBF for information on lock cores)
- All filing/storage units are 20" deep

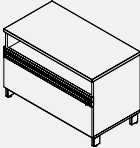
| | Description | Finish | SKU Number | Shpg Wt. (lbs) | Cube (ft.) | UPS/ Fed Ex | List Price |
|---|--|--------|------------|----------------|------------|-------------|------------|
|  | <p>36W x 30H 2 Drawer Lateral File</p> <ul style="list-style-type: none"> • Anti-tip safety mechanism • Lockable with single lock • 35.51"W x 19.49"D x 29.53"H •  (SIN 711-3) | White | 34F52WH | 148 | 19.1 | Yes | \$821.00 |
|  | <p>16W x 27H Mobile Pedestal</p> <ul style="list-style-type: none"> • Two 3/4-extension box drawers for miscellaneous supplies • Comes with two locking casters and two swivel casters • File drawers accept both legal and letter-size files • Sized to fit conveniently under Work Surfaces • 15.67"W x 19.13"D x 26.63"H •  (SIN 711-3) | White | 34F53WH | 74 | 8 | Yes | \$501.00 |

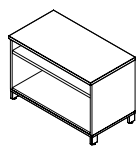

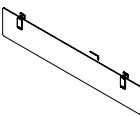
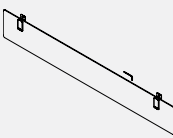

Momentum – Storage (con't)

| | Description | Finish | SKU Number | Shpg Wt. (lbs) | Cube (ft.) | Ups/ Fed Ex | List Price |
|---|--|--------|------------|----------------|------------|-------------|------------|
|  | <p>36W x 24H Piler/Filer</p> <ul style="list-style-type: none"> Includes pull-out storage shelf for active projects Drawer and pull-out shelf utilize full extension, ball-bearing suspensions Anti-tip safety mechanism Single lock secures both shelf and file drawer 35.51"W x 19.49"D x 24.06"H  (SIN 711-3) | White | 34F24WH | 138 | 16 | Yes | \$775.00 |
|  | <p>36W x 24H Open Storage</p> <ul style="list-style-type: none"> Includes one full-width, fully adjustable shelf for reference projects 35.51"W x 19.49"D x 24.05"H  (SIN 711-3) | White | 34S24WH | 104 | 16 | Yes | \$516.00 |

Momentum – Modesty Panels

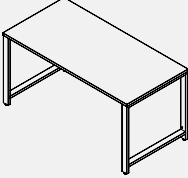
| | Description | Finish | SKU Number | Shpg Wt. (lbs) | Cube (ft.) | UPS/ Fed Ex | List Price |
|---|---|---------------|--------------|----------------|------------|-------------|------------|
|  | <p>48W x 9H Glass Modesty Panel</p> <ul style="list-style-type: none"> 5.0mm thick fully tempered frosted glass Attaches to 60W or Dog-Leg Work Surface support bar—installation tool included 47.99"W x 1.38"D x 9.15"H Not on GSA Contract | Frosted Glass | 34M148BKT-03 | 10 | .7 | Yes | \$135.00 |
|  | <p>60W x 9H Glass Modesty Panel</p> <ul style="list-style-type: none"> 5.0mm thick fully tempered frosted glass Attaches to 72W Work Surface support bar—installation tool included 60"W x 1.38"D x 9.15"H Not on GSA Contract | Frosted Glass | 34M160BKT-03 | 13 | .8 | Yes | \$156.00 |

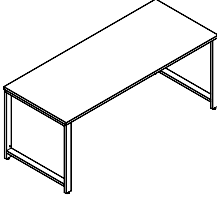
Momentum – Desking Kits

| | Description | Finish | SKU Number | List Price |
|---|---|-------------------------------|------------------------------|------------|
|  | <p>60W Table Desk</p> <ul style="list-style-type: none"> • 59.5"W x 29.5"D x 29.5"H •  (SIN 711-2) | Natural Maple Mocha Cherry | 34DKSD6030AC 34DKSD6030MR | \$727.00 |
|  | <p>72W Table Desk</p> <ul style="list-style-type: none"> • 71.63"W x 29.5"D x 29.5"H •  (SIN 711-2) | Natural Maple Mocha Cherry | 34DKSD7230AC 34DKSD7230MR | \$757.00 |



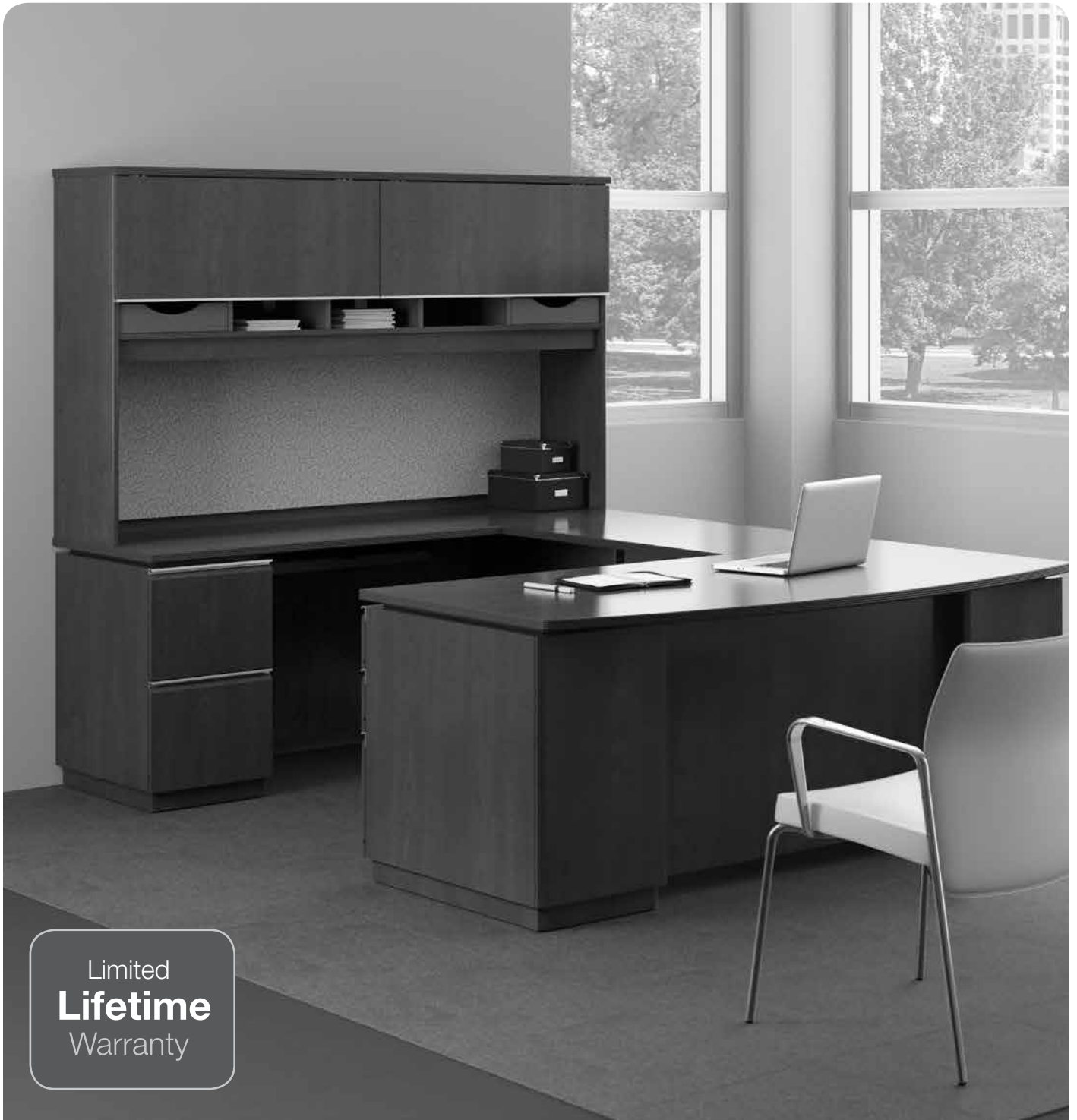



Milano2



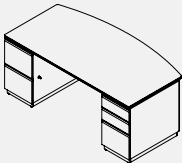

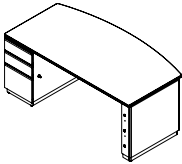

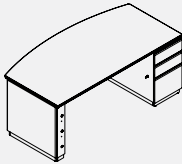

Limited
Lifetime
Warranty

Milano2 – Work Surfaces and Extensions

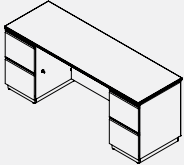

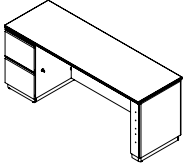

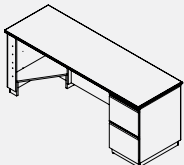

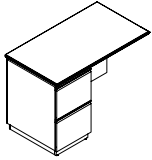

- ☑ Constructed with 100% thermally fused laminate for durability and superior resistance to scratches and stains
- ☑ Floating desktop detail
- ☑ Beaded edge treatment
- ☑ Full modesty panels
- ☑ Double Pedestal Desks have full depth pedestals and double depth file drawers
- ☑ All file drawers have full-extension, ball-bearing slides
- ☑ File drawers accommodate legal, letter, and A4 file sizes
- ☑ Pedestals ship fully assembled from factory
- ☑ Pedestals have single lock security device
- ☑ Drawer pulls constructed of extruded aluminum

| | Description | Finish | SKU Number | Shpg Wt. (lbs) | Cube (ft.) | UPS/Fed Ex | List Price |
|---|---|----------------|-------------|---------------------------------|-----------------------------------|------------|------------|
|  | <p>72W x 36D Bow Front Double Pedestal Desk</p> <ul style="list-style-type: none"> • Accepts Pencil Drawer/Keyboard Trays • Ships in two boxes • 71.1"W x 36.06"D x 28.98"H •  (SIN 711-8) | Harvest Cherry | 50DBF72CSK | Box 1 197 Box 2 86 | Box 1 21.5 Box 2 5.1 | No | \$1,812.00 |
|  | <p>72W x 36D LH Single Pedestal Bow Front Desk</p> <ul style="list-style-type: none"> • Accepts Pencil Drawer/Keyboard Trays • Ships in two boxes • Accepts Face Rail to finish single pedestal when not used as an L- or U-Desk configuration • 71.1"W x 36.06"D x 28.98"H •  (SIN 711-8) | Harvest Cherry | 50DBSL72CSK | Box 1 158 Box 2 86 | Box 1 20 Box 2 5.1 | No | \$1,670.00 |
|  | <p>72W x 36D RH Single Pedestal Bow Front Desk</p> <ul style="list-style-type: none"> • Accepts Pencil Drawer/Keyboard Trays • Ships in two boxes • Accepts Face Rail to finish single pedestal when not used as an L- or U-Desk configuration • 71.1"W x 36.06"D x 28.98"H •  (SIN 711-8) | Harvest Cherry | 50DBSR72CSK | Box 1 158 Box 2 86 | Box 1 20 Box 2 5.1 | No | \$1,670.00 |

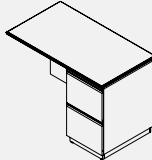
Milano2 – Work Surfaces and Extensions (con't)

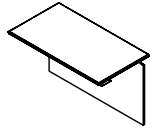



| | Description | Finish | SKU Number | Shpg Wt. (lbs) | Cube (ft.) | UPS/ Fed Ex | List Price |
|---|--|----------------|-------------|---------------------------------|-----------------------------------|-------------|------------|
|  | <p>72W x 24D Double Pedestal Kneespace Credenza</p> <ul style="list-style-type: none"> • Accepts Credenza 72W Hutch • Accepts Universal Drawer, Med. Track Keyboard Tray • Ships in two boxes • 71.1"W x 23.35"D x 28.98"H •  (SIN 711-8) | Harvest Cherry | 50C72CSK | Box 1 168 Box 2 59 | Box 1 19.2 Box 2 3.3 | No | \$1,578.00 |
|  | <p>72W x 24D LH Single Pedestal Credenza</p> <ul style="list-style-type: none"> • Accepts Credenza 72W Hutch • Accepts Universal Drawer, Med. Track Keyboard Tray • Ships in two boxes • Accepts Face Rail to finish single pedestal when not used as an L or U-Desk configuration • 71.1"W x 23.35"D x 28.98"H •  (SIN 711-8) | Harvest Cherry | 50CSPL72CSK | Box 1 137 Box 2 59 | Box 1 19.2 Box 2 3.3 | No | \$1,501.00 |
|  | <p>72W x 24D RH Single Pedestal Credenza</p> <ul style="list-style-type: none"> • Accepts Credenza 72W Hutch • Accepts Universal Drawer, Med. Track Keyboard Tray • Ships in two boxes • Accepts Face Rail to finish single pedestal when not used as an L or U-Desk configuration • 71.1"W x 23.35"D x 28.98"H •  (SIN 711-8) | Harvest Cherry | 50CSPR72CSK | Box 1 137 Box 2 59 | Box 1 19.2 Box 2 3.3 | No | \$1,501.00 |

Milano2 – Work Surfaces and Extensions (con't)

| | Description | Finish | SKU Number | Shpg Wt. (lbs) | Cube (ft.) | UPS/ Fed Ex | List Price |
|---|--|----------------|------------|----------------|------------|-------------|------------|
|  | <p>42W x 24D LH Single Pedestal Return</p> <ul style="list-style-type: none"> Mounts on RH Single Pedestal Desk or Credenza, 72W Desks and 72W Credenzas Accepts CPU Holder next to Pedestal 42.4"W x 23.35"D x 28.98"H  (SIN 711-8) | Harvest Cherry | 50RL42CS | 127 | 16.2 | No | \$824.00 |
|  | <p>42W x 24D RH Single Pedestal Return</p> <ul style="list-style-type: none"> Mounts on LH Single Pedestal Desk or Credenza, 72W Desks and 72W Credenzas Accepts CPU Holder next to Pedestal 42.4"W x 23.35"D x 28.98"H  (SIN 711-8) | Harvest Cherry | 50RR42CS | 127 | 16.2 | No | \$824.00 |
|  | <p>42W x 24D Bridge</p> <ul style="list-style-type: none"> Mounts between two 72W Desks or 72W Credenzas to form a U-configuration Accepts Pencil Drawer or Keyboard Shelf 43.98"W x 23.35"D x 26.43"H  (SIN 711-8) | Harvest Cherry | 50B42CS | 51 | 2.9 | Yes | \$386.00 |
|  | <p>Face Rail</p> <ul style="list-style-type: none"> For use with Single Pedestal Desks and Credenzas to finish desks when not used in a L or U-Desk configuration 4.86"W x 1"D x 24.8"H  (SIN 711-8) | Harvest Cherry | 50RFDCS | 3 | .3 | Yes | \$51.00 |

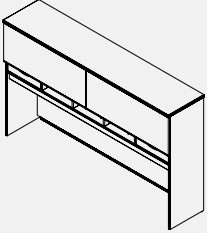

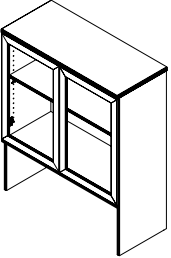
Milano2 – Hutch Storage

- ☑ Flipper door style with lid–stays to prevent accidental closing
- ☑ 36W Bookcase Hutch has frosted glass doors
- ☑ Door hardware constructed of extruded aluminum
- ☑ Includes coordinating, fabric-covered Tackboard
- ☑ Two work-in-progress storage bins included
- ☑ Accepts Task Light
- ☑ Flexible rubber strips along bottom edge provide concealed wire management
- ☑ Mount to Work Surfaces with commercial grade double-sided tape

| | Description | Finish | SKU Number | Shpg Wt. (lbs) | Cube (ft.) | UPS/ Fed Ex | List Price |
|---|---|----------------|------------|----------------|------------|-------------|------------|
|  | <p>72W Credenza Hutch</p> <ul style="list-style-type: none"> • Mounts on 72W Double or Single Pedestal Kneespace Credenza • Accepts two Task Lights • Flipper door assembled with lid stay to prevent accidental closing • 71.1"W x 15.35"D x 43.01"H •  (SIN 711-8) | Harvest Cherry | 50HC72CS | 217 | 22.3 | No | \$1,395.00 |
|  | <p>36W Bookcase Hutch with Glass Doors</p> <ul style="list-style-type: none"> • Mounts on 36W Storage Cabinet or 36W 2 Drawer Lateral File • One full-width adjustable shelf in upper compartment • Frosted – tempered framed glass doors • Doors utilize Euro-style hinges • Ships fully assembled • 35.55"W x 15.35"D x 43.01"H •  (SIN 711-8) | Harvest Cherry | 50HS36CS | 118 | 17.8 | No | \$798.00 |

Milano2 – Filing/Storage

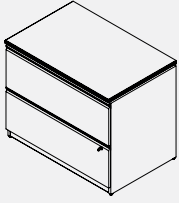
- Door and drawer hardware constructed of extruded aluminum
- File drawers accommodate legal, letter, and A4 file sizes and include hanging file management system
- Beaded edge treatment
- Ships fully assembled from factory
- Full-extension, ball-bearing slides

| | Description | Finish | SKU Number | Shpg Wt. (lbs) | Cube (ft.) | UPS/ Fed Ex | List Price |
|---|--|----------------|------------|----------------|------------|-------------|------------|
|  | <p>36W x 24D 2 Drawer Lateral File</p> <ul style="list-style-type: none"> • Accepts 36W Bookcase Hutch with Glass Doors • File drawers accept letter, legal or A4-sized hanging files • Face front lock in lower drawer that secures both drawers • Full-extension, ball-bearing slides • Includes anti-tip mechanism for safety • 35.55"W x 23.35"D x 28.98"H •  (SIN 711-8) | Harvest Cherry | 50F36CS | 167 | 20.6 | No | \$1,030.00 |



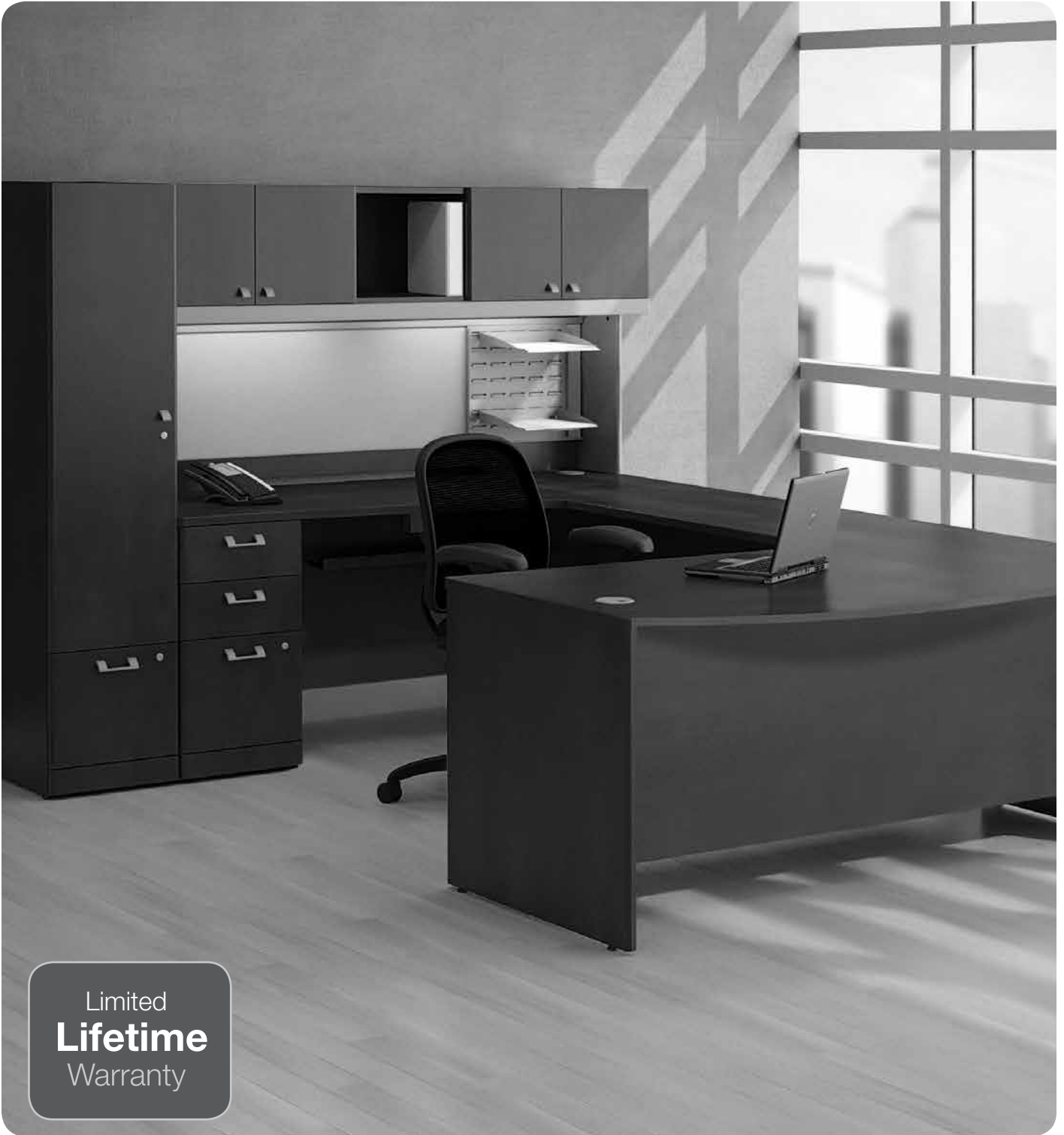





Quantum

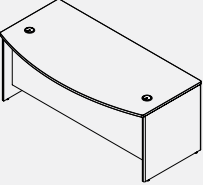

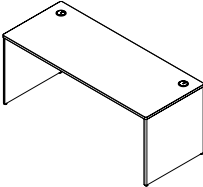

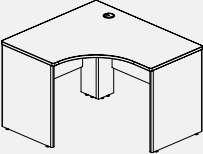

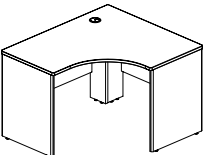



Limited
Lifetime
Warranty

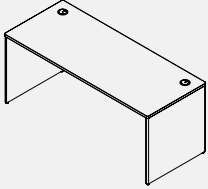

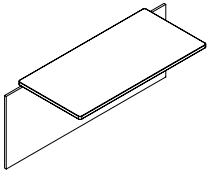

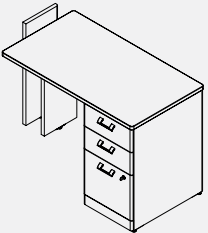
Quantum – Work Surfaces and Extensions

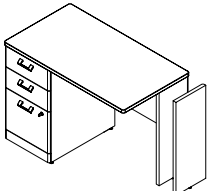
- Durable edge banding
- Constructed with 100% thermally fused laminate for durability and superior resistance to scratches and stains
- All file drawers have full-extension, ball-bearing slides
- Box drawers have 3/4-extension, ball-bearing slides
- Pre-installed “Quick and Easy” assembly hardware to assure rapid installation
- Wire management consisting of desktop grommets and wire raceways
- Pedestals have single locking security device
- File drawers accommodate all legal, letter and A4 file sizes
- Pre-drilled to accept ergonomic and storage accessories such as Keyboard Trays and drawers
- 72W Single Pedestal Desks and Credenzas accept Data/Power Hub accessory (sold separately)

| | Description | Finish | SKU Number | Shpg Wt. (lbs) | Cube (ft.) | UPS/ Fed Ex | List Price |
|---|---|----------------|------------|----------------|------------|-------------|------------|
|  | <p>72W x 36D Bow Front Desk Shell</p> <ul style="list-style-type: none"> • Accepts CPU Holder at left or right; Pencil Drawer or Keyboard Trays at left center, right center, or center; and Monitor Arm with Post in 3" grommet • Accepts Peninsulas, Returns, and 48W Bridge with another Desk to form a U-configuration • Bow Front on Desk has 12 1/4" overhang • 71.3"W x 35.43"D x 29.88"H •  (SIN 711-2) | Harvest Cherry | QT0725ACS | 143 | 5.3 | Yes | \$682.00 |
|  | <p>72W x 30D Desk Shell</p> <ul style="list-style-type: none"> • Accepts CPU Holder at left or right; Pencil Drawer or Keyboard Tray at left center, right center, or center; and Monitor Arm w/ Post in 3" grommet • Accepts 72W Hutch (Tall), Peninsulas, Returns, 48W Bridge with another Desk to form a U-configuration • Desk front designed with 6 1/2" overhang • 71.3"W x 29.21"D x 29.88"H •  (SIN 711-2) | Harvest Cherry | QT0705ACS | 135 | 5.4 | Yes | \$624.00 |
|  | <p>48W x 42D RH Corner</p> <ul style="list-style-type: none"> • Articulating Keyboard Trays in center, and Monitor Arm with Post in 3" grommet • Can be used with Peninsulas, Returns, and 48W Hutch • Two Peninsulas cannot be attached at the same time • 47.28"W x 42.13"D x 29.88"H •  (SIN 711-2) | Harvest Cherry | QT0465ACS | 118 | 5.1 | Yes | \$613.00 |
|  | <p>48W x 42D LH Corner</p> <ul style="list-style-type: none"> • Articulating Keyboard Trays in center, and Monitor Arm with Post in 3" grommet • Can be used with Peninsulas, Returns, and 48W Hutch • Two Peninsulas cannot be attached at the same time • 47.28"W x 42.13"D x 29.88"H •  (SIN 711-2) | Harvest Cherry | QT0455ACS | 118 | 5.1 | Yes | \$613.00 |

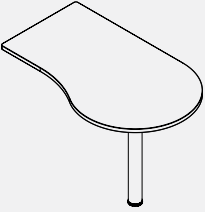

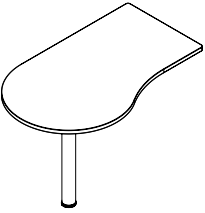



Quantum – Work Surfaces and Extensions (con't)



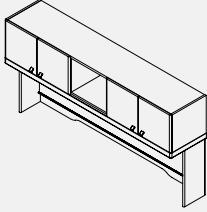

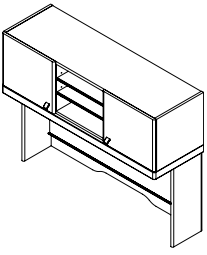

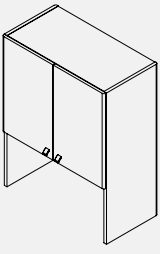



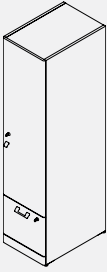

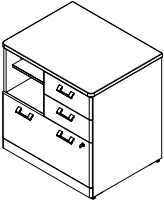
| | Description | Finish | SKU Number | Shpg Wt. (lbs) | Cube (ft.) | UPS/ Fed Ex | List Price |
|---|---|----------------|------------|----------------|------------|-------------|------------|
|  | <p>72W x 24D Credenza Shell</p> <ul style="list-style-type: none"> • Accepts CPU Holder at left or right; Pencil Drawer or Keyboard Trays at left, center or right; and Monitor Arm w/ Post in 3" grommet • Can be used with 72W Hutch, Returns, Peninsulas, 48W Bridge with another desk to form a U-configuration • 71.3"W x 23.39"D x 29.88"H •  (SIN 711-2) | Harvest Cherry | QT4725ACS | 109 | 4.4 | Yes | \$540.00 |
|  | <p>48W x 24D Bridge</p> <ul style="list-style-type: none"> • Mounts between two Desks or Credenzas to make a U-configuration • Accepts Pencil Drawer or Keyboard Trays • 47.28"W x 23.39"D x 29.88"H •  (SIN 711-2) | Harvest Cherry | QT6885ACS | 60 | 2.4 | Yes | \$361.00 |
|  | <p>42W x 24D RH Single Pedestal Return</p> <ul style="list-style-type: none"> • Accepts CPU Holder next to Pedestal • Mounts on Corner Desks, 72W Desks and 72W Credenzas • Pedestal has two box drawers each and one file drawer each that holds letter or legal-size files; central lock secures bottom two drawers • Includes second short leg for use when connecting to Corner Desk • 42.13"W x 23.39"D x 29.88"H •  (SIN 711-2) | Harvest Cherry | QT6405ACS | 129 | 14.2 | Yes | \$719.00 |
|  | <p>42W x 24D LH Single Pedestal Return</p> <ul style="list-style-type: none"> • Accepts CPU Holder next to Pedestal • Mounts on Corner Desks, 72W Desks and 72W Credenzas • Pedestal has two box drawers each and one file drawer each that holds letter or legal-size files; central lock secures bottom two drawers • Includes second short leg for use when connecting to Corner Desk • 42.13"W x 23.39"D x 29.88"H •  (SIN 711-2) | Harvest Cherry | QT6415ACS | 129 | 14.2 | Yes | \$719.00 |

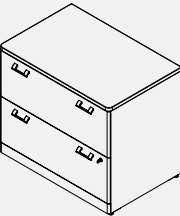
| | Description | Finish | SKU Number | Shpg Wt. (lbs) | Cube (ft.) | UPS/ Fed Ex | List Price |
|---|---|----------------|------------|----------------|------------|-------------|------------|
|  | <p>48W x 30D d Peninsula</p> <ul style="list-style-type: none"> • Peninsula can mount on RH Corner Desk, 72W Desk, and 72W Credenza • Cannot stand alone • 47.56"W x 29.21"D x 29.88"H •  (SIN 711-2) | Harvest Cherry | QT7465ACS | 54 | 3.8 | Yes | \$385.00 |
|  | <p>48W x 30D b Peninsula</p> <ul style="list-style-type: none"> • Peninsula can mount on LH Corner Desk, 72W Desk, and 72W Credenza • Cannot stand alone • 47.56"W x 29.21"D x 29.88"H •  (SIN 711-2) | Harvest Cherry | QT7455ACS | 54 | 3.8 | Yes | \$385.00 |

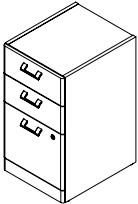
Quantum – Hutch Storage

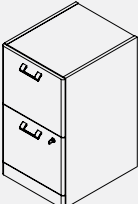
- ☑ Constructed of 100% thermally fused laminate
- ☑ Metal support frame to ensure long life
- ☑ Complete with Back Panel and Tackboard
- ☑ Accepts organization accessories such as Pencil Cup, and Metal White Board
- ☑ 30W Hutch does not contain Tackboard

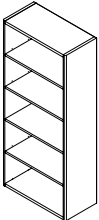
| | Description | Finish | SKU Number | Shpg Wt. (lbs) | Cube (ft.) | UPS/ Fed Ex | List Price |
|---|---|----------------|------------|---------------------------------|-----------------------------------|-------------|------------|
|  | <p>72W Hutch (Tall)</p> <ul style="list-style-type: none"> • Mounts on 72W Desks, 72W Credenzas, or two 2 Drawer Lateral Files • Tackboard rail accepts organizational accessories such as Metal White Board • Has two covered door storage compartments and one open active project management area • Pre-drilled to accept up to two Task Light accessories • Ships in two boxes • Total height when mounted to desk = 67" • 71.26"W x 15.24"D x 37.01"H •  (SIN 711-2) | Harvest Cherry | QT1726CSK | Box 1 47 Box 2 100 | Box 1 4.2 Box 2 15.4 | Yes | \$937.00 |
|  | <p>48W Hutch (Tall)</p> <ul style="list-style-type: none"> • Mounts on 48W x 42D Right or Left Corner Desk on the long edge • Tackboard rail accepts organizational accessories such as Metal White Board • Has two covered door storage compartments and one open active project management area with adjustable shelves • Pre-drilled to accept Task Light accessory • Total height when mounted to desk = 67" • 47.24"W x 15.24"D x 37.01"H •  (SIN 711-2) | Harvest Cherry | QT1485CS | 117 | 15.9 | Yes | \$750.00 |
|  | <p>30W Hutch (Tall)</p> <ul style="list-style-type: none"> • Mounts on 30W Piler/Filer • 30W Hutch has wire management grommet in Back Panel and concealed storage with one adjustable shelf (5 position options) • Ships fully assembled • No metal support frame • Total height when mounted to desk = 67" • 28.86"W x 13.78"D x 37.01"H •  (SIN 711-2) | Harvest Cherry | QT231FCS | 79 | 12.9 | Yes | \$512.00 |

| | Description | Finish | SKU Number | Shpg Wt. (lbs) | Cube (ft.) | UPS/ Fed Ex | List Price |
|---|---|----------------|------------|----------------|------------|-------------|------------|
|  | <p>16W x 24D Storage Tower (Tall)</p> <ul style="list-style-type: none"> Tall Storage Tower door mounts on left or right side One lockable file drawer with full-extension, ball-bearing slides Lockable door compartment with coat rod and one adjustable shelf Used to match tall Hutch height 15.75"W x 23.03"D x 66.89"H  (SIN 711-3) | Harvest Cherry | QT288FCS | 142 | 20.1 | Yes | \$977.00 |
|  | <p>30W x 24D Piler/Filer</p> <ul style="list-style-type: none"> Accepts 30W Hutch Has two box drawers with full-extension, ball-bearing slides File drawers accommodate all legal, letter and A4 file sizes and utilize full-extension, ball-bearing slides 29.17"W x 23.39"D x 29.88"H  (SIN 711-3) | Harvest Cherry | QT255FACS | 141 | 17.3 | Yes | \$804.00 |
|  | <p>36W x 24D 2 Drawer Lateral File</p> <ul style="list-style-type: none"> Use two Lateral Files side-by-side with 72W Hutch to create storage wall system File drawers accommodate all legal, letter and A4 file sizes and utilize full-extension, ball-bearing slides Desk height for extended Work Surface area 35.67"W x 23.39"D x 29.88"H  (SIN 711-3) | Harvest Cherry | QT256FACS | 148 | 21.3 | Yes | \$853.00 |
|  | <p>16W x 20D Pedestal</p> <ul style="list-style-type: none"> Fits conveniently under all Work Surface shells Two box drawers, one file drawer for letter- or legal-size files, and a central lock that secures bottom two drawers Top shelf fully finished • Full-extension slides 15.75"W x 19.11"D x 28.54"H  (SIN 711-3) | Harvest Cherry | QT243FCS | 74 | 8.1 | Yes | \$512.00 |
|  | <p>16W x 20D Pedestal</p> <ul style="list-style-type: none"> Fits conveniently under all Work Surface shells Two file drawers that accommodate letter- or legal-size files Top shelf fully finished • Full extension slides Central lock secures both drawers 15.75"W x 19.11"D x 28.54"H  (SIN 711-3) | Harvest Cherry | QT242FCS | 73 | 8.1 | Yes | \$508.00 |
|  | <p>30W x 15D 5 Shelf Bookcase</p> <ul style="list-style-type: none"> Matches the height of Tall Hutches and Tall Tower Three adjustable shelves for storage flexibility and two fixed shelves for stability 29.17"W x 14.61"D x 66.89"H  (SIN 711-3) | Harvest Cherry | QT3605CS | 109 | 3.5 | Yes | \$480.00 |



Realize



Limited
Lifetime
Warranty

Realize – Primary Work Surfaces

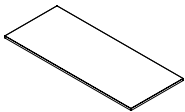









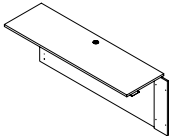

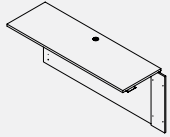
- Connects to any 30D Pedestal
- Durable, thermally fused laminate Work Surfaces features superior resistance to scratches and stains
- Durable impact-resistant 2.0mm edge banding
- Pre-drilled for accessories
- Attaches to any Secondary Work Surface, but DOES NOT connect to other Primary Work Surfaces
- Accepts Articulating Keyboard Tray (Left-Center-Right) position
- Accepts Drawers center position only

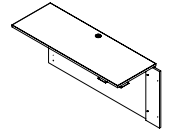
| | Description | Finish | SKU Number | Shpg Wt. (lbs) | Cube (ft.) | UPS/ Fed Ex | List Price |
|---|---|-------------------------------|----------------------------------|---------------------------------|--------------------------------|-------------|------------|
|  | 72W x 36D Bow Front Work Surface <ul style="list-style-type: none"> • 71.02"W x 36.06"D x 1"H •  (SIN 711-8) | Natural Maple Mocha Cherry | 22WDBF7236AC 22WDBF7236MR | 75 | 4.4 | Yes | \$403.00 |
|  | 72W x 30D Work Surface <ul style="list-style-type: none"> • 71.02"W x 29.61"D x 1"H •  (SIN 711-8) | Natural Maple Mocha Cherry | 22WD7230AC 22WD7230MR | 63 | 3.7 | Yes | \$349.00 |
|  | 66W x 30D Work Surface <ul style="list-style-type: none"> • 65.51"W x 29.61"D x 1"H •  (SIN 711-8) | Natural Maple Mocha Cherry | 22WD6630AC 22WD6630MR | 58 | 3.4 | Yes | \$311.00 |
|  | 60W x 30D Work Surface <ul style="list-style-type: none"> • 59.61"W x 29.61"D x 1"H •  (SIN 711-8) | Natural Maple Mocha Cherry | 22WD6030AC 22WD6030MR | 53 | 3.2 | Yes | \$261.00 |
|  | 48W x 30D Work Surface <ul style="list-style-type: none"> • 47.6"W x 29.61"D x 1"H •  (SIN 711-8) | Natural Maple Mocha Cherry | 22WD4830AC 22WD4830MR | 43 | 2.6 | Yes | \$233.00 |
|  | 72W x 30D Bullet Peninsula Work Surface Kit <ul style="list-style-type: none"> • Accepts 60"W Glass Modesty panel for Peninsula • 71.54"W x 29.61"D x 29.15"H •  (SIN 711-8) | Natural Maple Mocha Cherry | 22WPBT7230ACPK 22WPBT7230MRPK | Box 1 22 Box 2 102 | Box 1 2 Box 2 4.5 | Yes | \$658.00 |

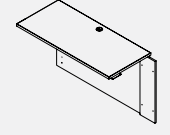

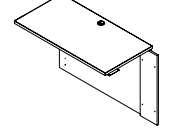

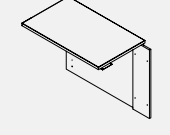

Realize – Secondary Work Surfaces

- ☑ Attach to any 22D Pedestal and/or End Panel
- ☑ Constructed of highly durable, 1" thick, 100% thermally fused laminate
- ☑ Durable impact-resistant 2.0mm thick edges
- ☑ Unsupported spans cannot exceed 72"
- ☑ Includes finished Back Panel and front Modesty Panel
- ☑ All surfaces include one connector Panel for connecting Back Panels together

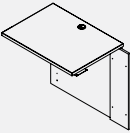
- ☑ Attach to any Primary or Secondary Work Surface
- ☑ All Secondary Surfaces include one 2" diameter grommet for wire management in the Work Surface (except the 36W, 24W, 18W)
- ☑ Pre-drilled for accessories
- ☑ Accepts Drawers in center position only (except 24" and lower)
- ☑ Accepts Medium Track Articulating Keyboard Tray in center position only (except 24" and lower)

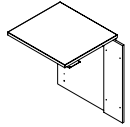

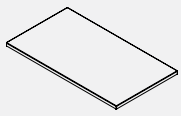







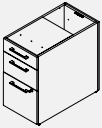

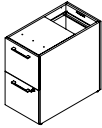
| | Description | Finish | SKU Number | Shpg Wt. (lbs) | Cube (ft.) | UPS/ Fed Ex | List Price |
|---|---|-------------------------------|--------------------------|----------------|------------|-------------|------------|
|  | 72W x 22D Secondary Surface <ul style="list-style-type: none"> • 71.02"W x 21.63"D x 29.15"H •  (SIN 711-8) | Natural Maple Mocha Cherry | 22WC7222AC 22WC7222MR | 88 | 4.5 | Yes | \$424.00 |
|  | 66W x 22D Secondary Surface <ul style="list-style-type: none"> • 65.51"W x 21.63"D x 29.15"H •  (SIN 711-8) | Natural Maple Mocha Cherry | 22WC6622AC 22WC6622MR | 81 | 4.2 | Yes | \$382.00 |
|  | 60W x 22D Secondary Surface <ul style="list-style-type: none"> • 59.61"W x 21.63"D x 29.15"H •  (SIN 711-8) | Natural Maple Mocha Cherry | 22WC6022AC 22WC6022MR | 74 | 3.8 | Yes | \$343.00 |
|  | 48W x 22D Secondary Surface <ul style="list-style-type: none"> • 47.6"W x 21.63"D x 29.15"H •  (SIN 711-8) | Natural Maple Mocha Cherry | 22WB4822AC 22WB4822MR | 62 | 3.1 | Yes | \$291.00 |
|  | 42W x 22D Secondary Surface <ul style="list-style-type: none"> • 41.61"W x 21.63"D x 29.15"H •  (SIN 711-8) | Natural Maple Mocha Cherry | 22WB4222AC 22WB4222MR | 54 | 2.7 | Yes | \$285.00 |
|  | 36W x 22D Secondary Surface/ Lateral File Top <ul style="list-style-type: none"> • 35.59"W x 21.63"D x 29.15"H •  (SIN 711-8) | Natural Maple Mocha Cherry | 22WB3622AC 22WB3622MR | 46 | 2.3 | Yes | \$277.00 |

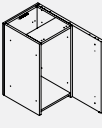
Realize – Secondary Work Surfaces (con't)

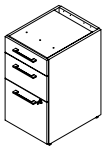

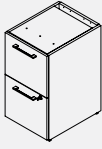

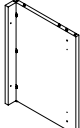

| | Description | Finish | SKU Number | Shpg Wt. (lbs) | Cube (ft.) | UPS/ Fed Ex | List Price |
|---|---|-------------------------------|--------------------------|----------------|------------|-------------|------------|
|  | <p>30W x 22D Secondary Surface</p> <ul style="list-style-type: none"> • 29.65"W x 21.63"D x 29.15"H •  (SIN 711-8) | Natural Maple Mocha Cherry | 22WB3022AC 22WB3022MR | 38 | 2.4 | Yes | \$257.00 |
|  | <p>24W x 22D Secondary Surface</p> <ul style="list-style-type: none"> • 23.62"W x 21.63"D x 29.15"H •  SIN 711-8) | Natural Maple Mocha Cherry | 22WB2422AC 22WB2422MR | 31 | 1.6 | Yes | \$249.00 |
|  | <p>42W x 24D Bridge</p> <ul style="list-style-type: none"> • Attaches to work surfaces as a bridge to create a U-configuration • 41.61"W x 23.15"D x 1.98"H •  (SIN 711-8) | Natural Maple Mocha Cherry | 22R4224AC 22R4224MR | 37 | 2.6 | Yes | \$305.00 |

Realize – Pedestals

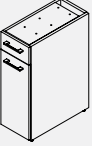
- ☑ All Pedestals are non-handed and can be used for right-handed or left-handed installation
- ☑ All file drawers utilize full-extension, ball-bearing slides
- ☑ All box drawers utilize 3/4-extension, ball-bearing slides
- ☑ Ships fully factory assembled
- ☑ 30D Pedestal File drawers are double depth
- ☑ 30D Pedestals accept any Modesty Panel
- ☑ 22D Pedestals can be combined with 16W Pedestal top to make a freestanding desk-height Pedestal
- ☑ All Pedestals include one interchangeable lock set which secures adjacent drawers
- ☑ All drawer locks are keyed alike (contact BBF for information on lock cores)

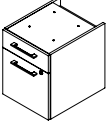
| | Description | Finish | SKU Number | Shpg Wt. (lbs) | Cube (ft.) | UPS/ Fed Ex | List Price |
|---|---|-------------------------------|--------------------------|----------------|------------|-------------|------------|
|  | 30D 3 Drawer Pedestal <ul style="list-style-type: none"> • 15.75"W x 29.13"D x 28.15"H •  (SIN 711-8) | Natural Maple Mocha Cherry | 22PD3BBFAC 22PD3BBFMR | 79 | 12.0 | Yes | \$525.00 |
|  | 30D 2 Drawer Pedestal <ul style="list-style-type: none"> • 15.75"W x 29.13"D x 28.15"H •  (SIN 711-8) | Natural Maple Mocha Cherry | 22PD2FFAC 22PD2FFMR | 88 | 12.0 | Yes | \$525.00 |
|  | 30D False Pedestal <ul style="list-style-type: none"> • 15.75"W x 29.25"D x 28.15"H •  (SIN 711-8) | Natural Maple Mocha Cherry | 22PDFAC 22PDFMR | 71 | 12.6 | Yes | \$292.00 |
|  | 22D 3 Drawer Pedestal <ul style="list-style-type: none"> • 15.75"W x 20.28"D x 28.15"H •  (SIN 711-8) | Natural Maple Mocha Cherry | 22PC3BBFAC 22PC3BBFMR | 67 | 8.7 | Yes | \$456.00 |
|  | 22D 2 Drawer Pedestal <ul style="list-style-type: none"> • 15.75"W x 20.28"D x 28.15"H •  (SIN 711-8) | Natural Maple Mocha Cherry | 22PC2FFAC 22PC2FFMR | 65 | 8.7 | Yes | \$456.00 |
|  | 22D End Panel <ul style="list-style-type: none"> • 3.56"W x 20.39"D x 28.15"H •  (SIN 711-8) | Natural Maple Mocha Cherry | 22PCFAC 22PCFMR | 20 | 1.0 | Yes | \$183.00 |

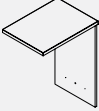
Realize – Pedestals (con't)

| | Description | Finish | SKU Number | Shpg Wt. (lbs) | Cube (ft.) | UPS/ Fed Ex | List Price |
|---|--|-------------------------------|--------------------------|----------------|------------|-------------|------------|
|  | <p>22D Half Width Pedestal</p> <ul style="list-style-type: none"> • For storage of computer or brief cases • 9.57"W x 20.28"D x 28.15"H •  (SIN 711-8) | Natural Maple Mocha Cherry | 22PCHWBDAC 22PCHWBDMR | 48 | 5.9 | Yes | \$376.00 |
|  | <p>19D 2 Drawer 3/4 Pedestal</p> <ul style="list-style-type: none"> • Mounts on the left or right side of any 30d or 22d work surface against any full width end panel • 15.51"W x 18.86"D x 18.74"H •  (SIN 711-8) | Natural Maple Mocha Cherry | 22PD2BFAC 22PD2BFMR | 45 | 7.2 | Yes | \$357.00 |
|  | <p>16W x 22D Pedestal Top</p> <ul style="list-style-type: none"> • 15.98"W x 21.63"D x 29.15"H •  (SIN 711-8) | Natural Maple Mocha Cherry | 22WT1622AC 22WT1622MR | 20 | 1.1 | Yes | \$96.00 |











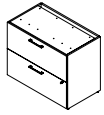

Realize – Filing/Storage

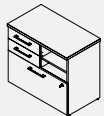

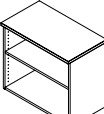

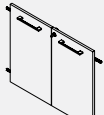

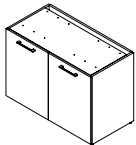



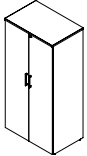

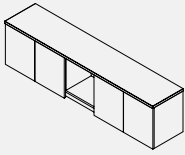

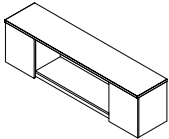
Upper

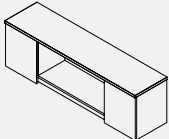
- Upper compartments are fully assembled from the factory
- Wall-mount options include wall-mount rails, but DO NOT include hardware for securing to the wall
- All doors utilize Euro-style hinges
- Hutches can accept Task Lights

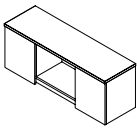
Lower

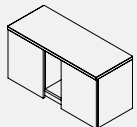
- Fits conveniently under any Primary or Secondary Work Surface
- All file drawers utilize full-extension, ball-bearing slides
- All box drawers utilize 3/4-extension, ball-bearing slides

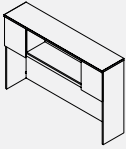





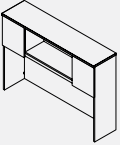
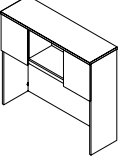
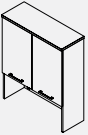
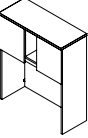
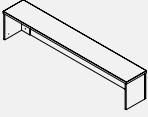
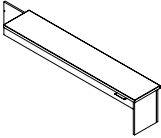

| | Description | Finish | SKU Number | Shpg Wt. (lbs) | Cube (ft.) | UPS/Fed Ex | List Price |
|---|---|-------------------------------|--------------------------|-----------------------------|-------------------------------|------------|------------|
|  | 36W 2 Drawer Lateral File Kit <ul style="list-style-type: none"> • Flush to all Primary and Secondary Work Surfaces • 35.59"W x 21.63"D x 29.17"H •  (SIN 711-8) | Natural Maple Mocha Cherry | 22FL236ACK 22FL236MRK | Box 1 112 Box 2 44 | Box 1 17.7 Box 2 1.9 | Yes | \$947.00 |
|  | 36W 2 Drawer Lateral File Shell <ul style="list-style-type: none"> • Use under Secondary Work Surface • 35.35"W x 20.28"D x 28.15"H •  (SIN 711-8) | Natural Maple Mocha Cherry | 22FSL236AC 22FSL236MR | 112 | 17.7 | Yes | \$670.00 |
|  | 30W Lower Piler/File Cabinet <ul style="list-style-type: none"> • Fits conveniently under any Primary or Secondary Work Surface • 29.72"W x 16.93"D x 25.98"H •  (SIN 711-8) | Natural Maple Mocha Cherry | 22FP30AC 22FP30MR | 100 | 12.3 | Yes | \$587.00 |
|  | 30W Lower Bookcase Cabinet <ul style="list-style-type: none"> • Fits conveniently under any Primary or Secondary Work Surface • Accepts 30W Door Kit • One Adjustable Shelf • 29.72"W x 16.93"D x 25.98"H •  (SIN 711-8) | Natural Maple Mocha Cherry | 22BK302AC 22BK302MR | 62 | 12.3 | Yes | \$307.00 |
|  | 30W Door Kit <ul style="list-style-type: none"> • Use with 30W Lower Bookcase Cabinet • 29.37"W x 0.63"D x 23.86"H •  (SIN 711-8) | Natural Maple Mocha Cherry | 22DR30WAC 22DR30WMR | 14 | 1.3 | Yes | \$169.00 |
|  | 40W Storage Cabinet with Doors <ul style="list-style-type: none"> • Fits under Secondary Work Surface • Use with two 22D Pedestals to construct storage credenza with 72W Secondary Surface • One Adjustable Shelf • 39.17"W x 20.2"D x 28.15"H •  (SIN 711-8) | Natural Maple Mocha Cherry | 22SD40AC 22SD40MR | 130 | 19.9 | Yes | \$375.00 |

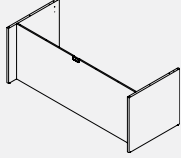
| | Description | Finish | SKU Number | Shpg Wt. (lbs) | Cube (ft.) | UPS/ Fed Ex | List Price |
|---|--|-------------------------------|------------------------|------------------------------|-------------------------------|-------------|------------|
|  | 36W Wardrobe Storage Cabinet <ul style="list-style-type: none"> One fixed shelf and three adjustable shelves for storage flexibility 35.67"W x 23.35"D x 72.14"H  (SIN 711-8) | Natural Maple Mocha Cherry | 22WS36ACK 22WS36MRK | Box 1 113 Box 2 126 | Box 1 5.2 Box 2 5.7 | Yes | \$932.00 |
|  | 72W Wall Mount Cabinet with Doors Kit <ul style="list-style-type: none"> 70.94"W x 14.96"D x 17.97"H Ships in two boxes  (SIN 711-8) | Natural Maple Mocha Cherry | 22HW72ACK 22HW72MRK | Box 1 99 Box 2 16 | Box 1 15.5 Box 2 1.0 | Yes | \$597.00 |
|  | 66W Wall Mount Cabinet with Doors Kit <ul style="list-style-type: none"> 65.12"W x 14.96"D x 17.97"H Ships in two boxes  (SIN 711-8) | Natural Maple Mocha Cherry | 22HW66ACK 22HW66MRK | Box 1 73 Box 2 16 | Box 1 3.5 Box 2 1.0 | Yes | \$587.00 |
|  | 60W Wall Mount Cabinet with Doors Kit <ul style="list-style-type: none"> 59.53"W x 14.96"D x 17.97"H Ships in two boxes  (SIN 711-8) | Natural Maple Mocha Cherry | 22HW60ACK 22HW60MRK | Box 1 67 Box 2 16 | Box 1 3.2 Box 2 1.0 | Yes | \$578.00 |
|  | 48W Wall Mount Cabinet with Doors Kit <ul style="list-style-type: none"> 47.52"W x 14.96"D x 17.97"H Ships in two boxes  (SIN 711-8) | Natural Maple Mocha Cherry | 22HW48ACK 22HW48MRK | Box 1 54 Box 2 16 | Box 1 2.6 Box 2 1.0 | Yes | \$558.00 |
|  | 36W Wall Mount Cabinet with Doors Kit <ul style="list-style-type: none"> Accepts one Task Light 35.51"W x 14.69"D x 17.95"H  (SIN 711-8) | Natural Maple Mocha Cherry | 22HW36ACK 22HW36MRK | Box 1 62 Box 2 14 | Box 1 10.5 Box 2 1.1 | Yes | \$533.00 |
|  | 72W Tall Hutch Storage with Doors Kit <ul style="list-style-type: none"> 70.94"W x 14.96"D x 43.03"H Ships in two boxes  (SIN 711-8) | Natural Maple Mocha Cherry | 22HT72ACK 22HT72MRK | Box 1 99 Box 2 78 | Box 1 15.5 Box 2 3.8 | Yes | \$893.00 |
|  | 66W Tall Hutch Storage with Doors Kit <ul style="list-style-type: none"> 65.12"W x 14.96"D x 43.03"H Ships in two boxes  (SIN 711-8) | Natural Maple Mocha Cherry | 22HT66ACK 22HT66MRK | Box 1 91 Box 2 73 | Box 1 14.3 Box 2 3.5 | Yes | \$883.00 |

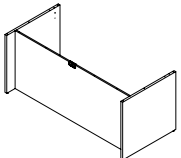
Realize – Filing/Storage (con't)

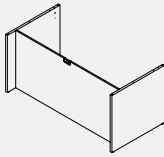
| | Description | Finish | SKU Number | Shpg Wt. (lbs) | Cube (ft.) | UPS/ Fed Ex | List Price |
|---|--|-------------------------------|--------------------------|----------------------------|-------------------------------|-------------|------------|
|  | 60W Tall Hutch Storage with Doors Kit <ul style="list-style-type: none"> • 59.53"W x 14.96"D x 43.03"H • Ships in two boxes • GSA APPROVED (SIN 711-8) | Natural Maple Mocha Cherry | 22HT60ACK 22HT60MRK | Box 1 83 Box 2 67 | Box 1 12.9 Box 2 3.2 | Yes | \$874.00 |
|  | 48W Tall Hutch Storage with Doors Kit <ul style="list-style-type: none"> • 47.52"W x 14.96"D x 43.03"H • Ships in two boxes • GSA APPROVED (SIN 711-8) | Natural Maple Mocha Cherry | 22HT48ACK 22HT48MRK | Box 1 67 Box 2 54 | Box 1 10.4 Box 2 2.6 | Yes | \$854.00 |
|  | 36W Tall Hutch Storage with Doors <ul style="list-style-type: none"> • 35.51"W x 14.69"D x 43.03"H • One Adjustable Shelf • GSA APPROVED (SIN 711-8) | Natural Maple Mocha Cherry | 22HS36DRAC 22HS36DRMR | 103 | 20.2 | Yes | \$471.00 |
|  | 36W Tall Hutch Storage with Doors Kit <ul style="list-style-type: none"> • Mounts to any 36W Work Surface, Storage Cabinet, or Lateral File • Mounts to Work Surface using commercial grade double-sided adhesive • 35.51"W x 14.69"D x 43.03"H • GSA APPROVED (SIN 711-8) | Natural Maple Mocha Cherry | 22HT36ACK 22HT36MRK | Box 1 51 Box 2 62 | Box 1 3.5 Box 2 10.5 | Yes | \$828.00 |
|  | Receptionist Shelf–Straight 72W <ul style="list-style-type: none"> • Use with 72W Work Surface • 70.94"W x 11.61"D x 14.39"H • GSA APPROVED (SIN 711-8) | Natural Maple Mocha Cherry | 22RGM72AC 22RGM72MR | 58 | 2.2 | Yes | \$511.00 |
|  | Receptionist Shelf–Return 60W <ul style="list-style-type: none"> • Use as Return for 72 x 72 reception • 61.28"W x 11.61"D x 14.39"H • GSA APPROVED (SIN 711-8) | Natural Maple Mocha Cherry | 22RGR60AC 22RGR60MR | 43 | 1.7 | Yes | \$480.00 |

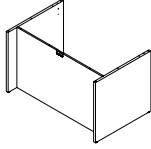
Realize – Desk Shell Base Kits









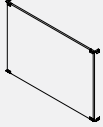
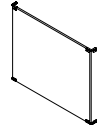
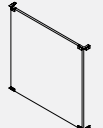
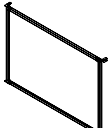
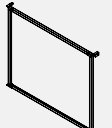
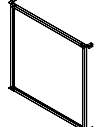
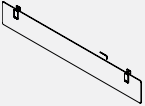

| | Description | Finish | SKU Number | List Price |
|---|--|-------------------------------|----------------------------------|------------|
|  | <p>72W x 30D Shell Desk Base Kit</p> <ul style="list-style-type: none"> • 71.13"W x 29.63"D x 28.13"H •  (SIN 711-8) | Natural Maple Mocha Cherry | 22SBASE7230ACK 22SBASE7230MRK | \$276.00 |
|  | <p>66W x 30D Shell Desk Base Kit</p> <ul style="list-style-type: none"> • 65.13"W x 29.63"D x 28.13"H •  (SIN 711-8) | Natural Maple Mocha Cherry | 22SBASE6630ACK 22SBASE6630MRK | \$259.00 |
|  | <p>60W x 30D Shell Desk Base Kit</p> <ul style="list-style-type: none"> • 59.63"W x 29.63"D x 28.13"H •  (SIN 711-8) | Natural Maple Mocha Cherry | 22SBASE6030ACK 22SBASE6030MRK | \$247.00 |
|  | <p>48W x 30D Shell Desk Base Kit</p> <ul style="list-style-type: none"> • 47.63"W x 29.63"D x 28.13"H •  (SIN 711-8) | Natural Maple Mocha Cherry | 22SBASE4830ACK 22SBASE4830MRK | \$247.00 |

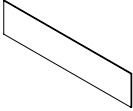
Realize – Modesty Panels

Not required for support

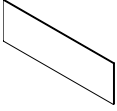
Full height

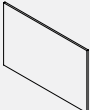
| | Description | Finish | SKU Number | Shpg Wt. (lbs) | Cube (ft.) | UPS/ Fed Ex | List Price |
|---|--|-------------------------------|------------------------|----------------|------------|-------------|------------|
|  | Wood Modesty Panel for 72W Desk <ul style="list-style-type: none"> • 39.13"W x 0.63"D x 28.15"H • GSA APPROVED (SIN 711-8) | Natural Maple Mocha Cherry | 22MWF72AC 22MWF72MR | 27 | 2.3 | Yes | \$169.00 |
|  | Wood Modesty Panel for 66W Desk <ul style="list-style-type: none"> • 33.31"W x 0.63"D x 28.15"H • GSA APPROVED (SIN 711-8) | Natural Maple Mocha Cherry | 22MWF66AC 22MWF66MR | 23 | 2.0 | Yes | \$150.00 |
|  | Wood Modesty Panel for 60W Desk <ul style="list-style-type: none"> • 27.72"W x 0.63"D x 28.15"H • GSA APPROVED (SIN 711-8) | Natural Maple Mocha Cherry | 22MWF60AC 22MWF60MR | 20 | 1.7 | Yes | \$138.00 |
|  | Glass Modesty Panel for 72W Desk <ul style="list-style-type: none"> • 39.13"W x 0.91"D x 28.15"H • Not on GSA Contract | Frosted Glass | 22MG72FR-03 | 25 | 2.5 | Yes | \$500.00 |
|  | Glass Modesty Panel for 66W Desk <ul style="list-style-type: none"> • 33.31"W x 0.91"D x 28.15"H • Not on GSA Contract | Frosted Glass | 22MG66FR-03 | 22 | 2.2 | Yes | \$452.00 |
|  | Glass Modesty Panel for 60W Desk <ul style="list-style-type: none"> • 27.72"W x 0.91"D x 28.15"H • Not on GSA Contract | Frosted Glass | 22MG60FR-03 | 20 | 1.8 | Yes | \$400.00 |
|  | 60W Glass Modesty Panel for Bullet Peninsula <ul style="list-style-type: none"> • 60"W x 1.38"D x 9.15"H • Not on GSA Contract | FROSTED GLASS | 34M160BKT-03 | 13 | .8 | Yes | \$156.00 |

| | Description | Finish | SKU Number | Shpg Wt. (lbs) | Cube (ft.) | UPS/ Fed Ex | List Price |
|---|--|--|--|----------------|------------|-------------|------------|
|  | 72W Tackboard <ul style="list-style-type: none"> • 67.24"W x 0.59"D x 20.47"H •  (SIN 711-8) | Morning Dew Sahara Plains Truro Dune Serengetti Night | 22TB72SD 22TB72SP 22TB72TD 22TB72CP | 14 | 1.4 | Yes | \$196.00 |
|  | 66W Tackboard <ul style="list-style-type: none"> • 61.42"W x 0.59"D x 20.47"H •  (SIN 711-8) | Morning Dew Sahara Plains Truro Dune Serengetti Night | 22TB66SD 22TB66SP 22TB66TD 22TB66CP | 13 | 1.3 | Yes | \$180.00 |
|  | 60W Tackboard <ul style="list-style-type: none"> • 55.83"W x 0.59"D x 20.47"H •  (SIN 711-8) | Morning Dew Sahara Plains Truro Dune Serengetti Night | 22TB60SD 22TB60SP 22TB60TD 22TB60CP | 12 | 1.2 | Yes | \$165.00 |
|  | 48W Tackboard <ul style="list-style-type: none"> • 43.82"W x 0.59"D x 20.47"H •  (SIN 711-8) | Morning Dew Sahara Plains Truro Dune Serengetti Night | 22TB48SD 22TB48SP 22TB48TD 22TB48CP | 10 | .9 | Yes | \$149.00 |
|  | 36W Tackboard <ul style="list-style-type: none"> • 20.47"W x 0.51"D x 31.50"H •  (SIN 711-8) | Morning Dew Sahara Plains Truro Dune Serengetti Night | 22TB36SD 22TB36SP 22TB36TD 22TB36CP | 8 | 1.1 | Yes | \$134.00 |

Enterprise

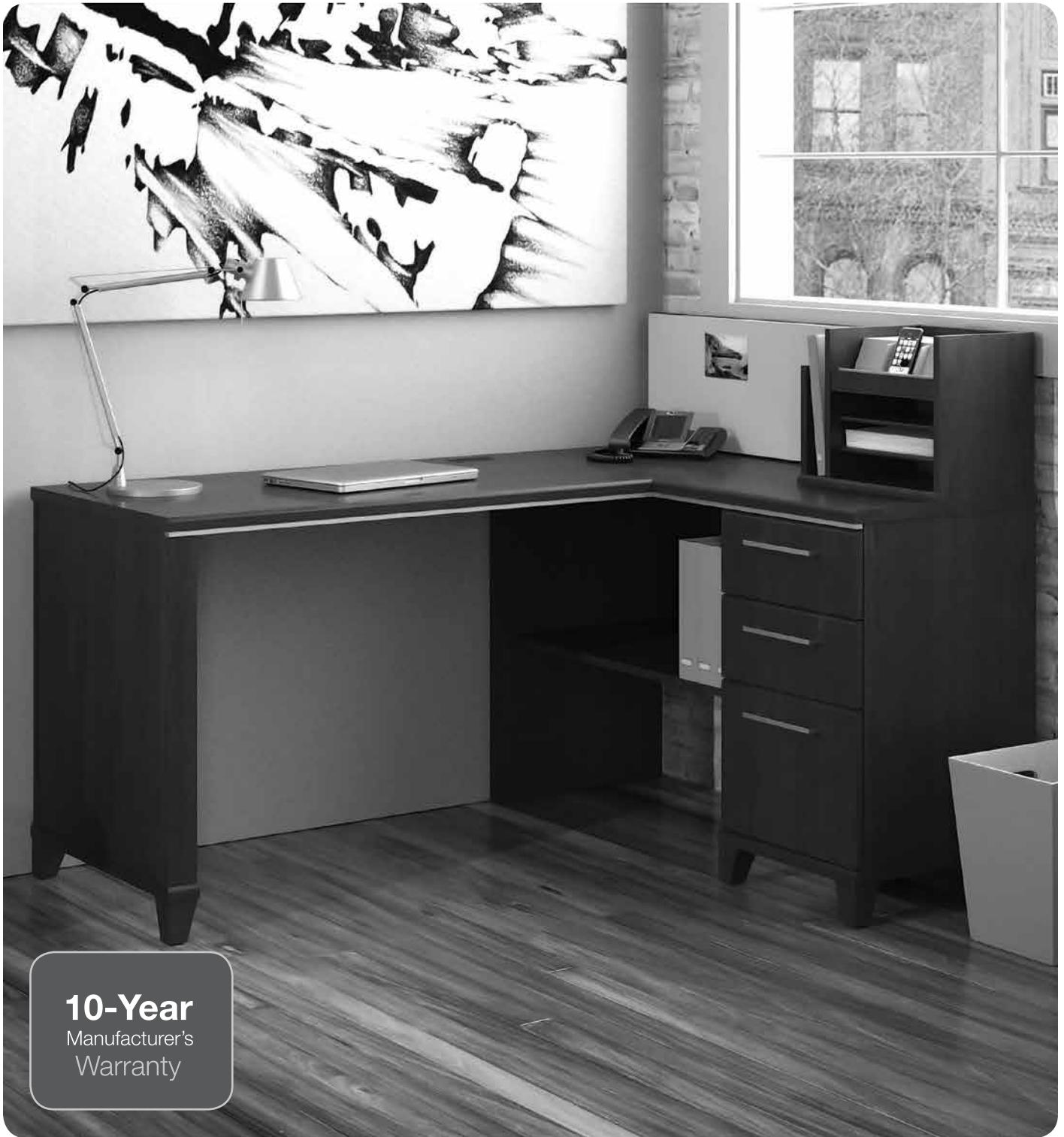

10-Year
Manufacturer's
Warranty

Enterprise – Work Surfaces

- ☑ Constructed with 100% thermally fused laminate for durability and superior resistance to scratches and stains
- ☑ Pre-drilled to accept Keyboard Trays
- ☑ Includes one 4-port USB hub and one wire management grommet in each main work surface
- ☑ Shelves with clipped back corners for easy wire management
- ☑ All file and box drawers utilize full-extension, ball-bearing slides
- ☑ All file drawers accommodate letter, legal, and A4 size files
- ☑ All units designed to assemble in 30 minutes or less
- ☑ All Work Surfaces fully finished with approach sides
- ☑ All Pedestals ship fully factory assembled

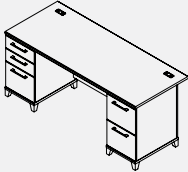
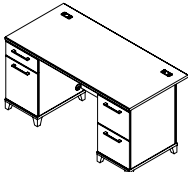
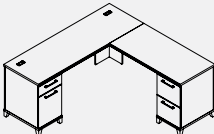
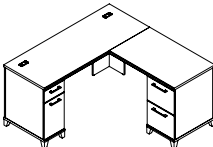
| | Description | Finish | SKU Number | Shpg Wt. (lbs) | Cube (ft.) | UPS/ Fed Ex | List Price |
|---|---|--------------------------------|--------------------------|----------------------------------|-----------------------------------|-------------|------------|
|  | <p>72W x 30D Double Pedestal Desk</p> <ul style="list-style-type: none"> • Will accept 72W Hutch • Includes one 3 Drawer Pedestal • Includes one 2 Drawer Pedestal • Ships in two boxes • 70.12"W x 28.58"D x 29.69"H • Not on GSA Contract | Mocha Cherry Harvest Cherry | 2972MC-03K 2972CS-03K | Box 1 148 Box 2 78 | Box 1 18.2 Box 2 5.4 | Yes | \$1,154.00 |
|  | <p>60W x 30D Double Pedestal Desk</p> <ul style="list-style-type: none"> • Will accept 60W Hutch • Includes one 2 Drawer Storage Pedestal • Includes one 2 Drawer Pedestal • Ships in two boxes • 60.71"W x 28.58"D x 29.69"H • Not on GSA Contract | Mocha Cherry Harvest Cherry | 2960MC-03K 2960CS-03K | Box 1 135 Box 2 64 | Box 1 18.2 Box 2 4.7 | Yes | \$1,041.00 |
|  | <p>72W x 72D L-Desk</p> <ul style="list-style-type: none"> • Will accept 72W Hutch in two positions • Includes one 2 Drawer Storage Pedestal • Includes one 2 Drawer Pedestal • Ships in two boxes • Work Surface 70.13"W x 23.13"D • Return 46.88"W x 23.13"D • All drawers full-extension • 70.12"W x 70.12"D x 29.69"H • Not on GSA Contract | Mocha Cherry Harvest Cherry | 2910MC-03K 2910CS-03K | Box 1 135 Box 2 114 | Box 1 18.2 Box 2 7.1 | Yes | \$1,196.00 |
|  | <p>60W x 60D L-Desk</p> <ul style="list-style-type: none"> • Will accept 60W Hutch in two positions • Includes one 2 Drawer Storage Pedestal • Includes one 2 Drawer Pedestal • Ships in two boxes • Work Surface 60"W x 23.13"D • Return 40.13"W x 23.13"D • All drawers full-extension • 60"W x 60"D x 29.69"H • Not on GSA Contract | Mocha Cherry Harvest Cherry | 2930MC-03K 2930CS-03K | Box 1 135 Box 2 97 | Box 1 15.8 Box 2 6.2 | Yes | \$1,080.00 |

Enterprise – Work Surfaces (con't)

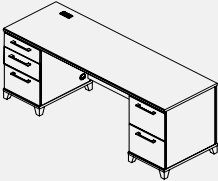
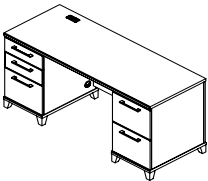
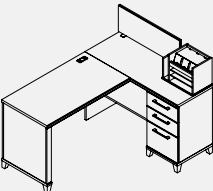
| | Description | Finish | SKU Number | Shpg Wt. (lbs) | Cube (ft.) | UPS/ Fed Ex | List Price |
|---|---|--------------------------------|--------------------------|---------------------------------|-----------------------------------|-------------|------------|
|  | <p>72W x 24D Double Pedestal Kneespace Credenza</p> <ul style="list-style-type: none"> • Includes one 3 Drawer Pedestal • Includes one 2 Drawer Pedestal • Pedestals ship pre-assembled • Accepts 72W Hutch • Integrated 4-port USB hub • All drawers full-extension • Ships in two boxes • 70.12"W x 23.19"D x 29.7"H • Not on GSA Contract | Mocha Cherry Harvest Cherry | 2927MC-03K 2927CS-03K | Box 1 148 Box 2 67 | Box 1 18.2 Box 2 4.4 | Yes | \$1,146.00 |
|  | <p>60W x 24D Double Pedestal Kneespace Credenza</p> <ul style="list-style-type: none"> • Includes one 3 Drawer Pedestal • Includes one 2 Drawer Pedestal • Accepts 60W Hutch • Pedestals ship pre-assembled • Integrated 4-port USB hub • All drawers full-extension • Ships in two boxes • 60"W x 23.19"D x 29.7"H • Not on GSA Contract | Mocha Cherry Harvest Cherry | 2926MC-03K 2926CS-03K | Box 1 148 Box 2 56 | Box 1 18.2 Box 2 3.9 | Yes | \$1,097.00 |
|  | <p>60W x 47D Corner Desk Solution</p> <ul style="list-style-type: none"> • Includes one 3 Drawer Pedestal • Contains one charging station in micro Hutch • Micro Hutch can mount in multiple locations • Comes with one fabric-covered Tackboard • All drawers full-extension • Ships in two boxes • 59.97"W x 47.17"D x 41.75"H • Not on GSA Contract | Mocha Cherry Harvest Cherry | 2999MC-03K 2999CS-03K | Box 1 65 Box 2 120 | Box 1 7.3 Box 2 7.3 | Yes | \$1,043.00 |



Enterprise – Storage

Hutch Storage

- ☑ Aluminum door hardware and edge detail
- ☑ Shelves with clipped back corners for easy wire management
- ☑ Constructed of 100% thermally fused laminate
- ☑ 72W Hutch and 30W Lateral File Hutch feature Flipper-style doors with lid-stays to prevent accidental closing
- ☑ 60W Hutch has sliding doors to protect open storage compartments and accommodate reference storage

Filing

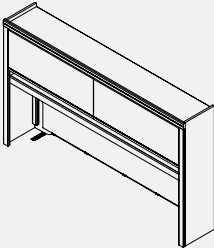
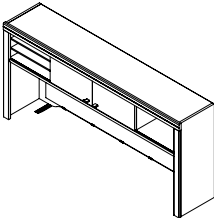
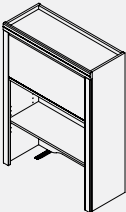
- ☑ File drawers accommodate legal, letter, and A4 file sizes and include hanging file management system
- ☑ File drawers utilize full-extension, ball-bearing slides
- ☑ Ships fully assembled
- ☑ Aluminum door and drawer hardware and edge detail
- ☑ Constructed of 100% thermally fused laminate

| | Description | Finish | SKU Number | Shpg Wt. (lbs) | Cube (ft.) | UPS/Fed Ex | List Price |
|---|--|--------------------------------|--------------------------|---------------------------------|-----------------------------------|------------|------------|
|  | <p>72W Hutch</p> <ul style="list-style-type: none"> • Flipper style doors with lid stays to prevent accidental closing • Includes Back Panel and Tackboard 61.38" x 18.13" • Can accept up to two Task Light accessories • Mounts to either the 72W Double Pedestal Desk, 72W x 72D L-Desk, and 72W Credenza • Includes open work-in-process compartments to help organize paper • Ships in two boxes • 70.12"W x 12.28"D x 41.71"H • Not on GSA Contract | Mocha Cherry Harvest Cherry | 2973MC-03K 2973CS-03K | Box 1 109 Box 2 60 | Box 1 17.2 Box 1 4.4 | Yes | \$845.00 |
|  | <p>60W Hutch</p> <ul style="list-style-type: none"> • Sliding doors protect open storage compartments • Includes Back Panel and coordinating Tackboard 52.88W x 14.5D • Mounts to either the 60W Double Pedestal or 60W x 60D L-Desk • Includes open work-in-process compartments to help organize papers, accommodates Task Light • 60"W x 12.28"D x 27.72"H • Not on GSA Contract | Mocha Cherry Harvest Cherry | 2961MC-03 2961ACS-03 | 101 | 12.3 | Yes | \$667.00 |
|  | <p>30W Lateral File Hutch</p> <ul style="list-style-type: none"> • Mounts to 30W 2 Drawer Lateral File • Flipper style door with lid prevents accidental closing • Adjustable shelf • 30"W x 12.2"D x 41.71"H • Not on GSA Contract | Mocha Cherry Harvest Cherry | 2955MC-03 2955ACS-03 | 80 | 14.2 | Yes | \$422.00 |
|  | <p>30W 2 Drawer Lateral File</p> <ul style="list-style-type: none"> • Anti-tip safety mechanism • Lockable with single lock • Accepts Lateral File Hutch • 30"W x 23.19"D x 29.69"H • Not on GSA Contract | Mocha Cherry Harvest Cherry | 2954MC-03 2954ACS-03 | 125 | 17.6 | Yes | \$667.00 |

Syndicate



10-Year
Manufacturer's
Warranty

Syndicate – Work Surfaces

- ☑ Constructed with 100% thermally fused laminate for durability and superior resistance to scratches and stains
- ☑ Pre-drilled to accept Keyboard Trays
- ☑ Includes one 4-port USB hub and one wire management grommet in each main Work Surface
- ☑ Shelves with clipped back corners for easy wire management
- ☑ All file and box drawers utilize full-extension, ball-bearing slides
- ☑ All units designed to assemble in 30 minutes or less
- ☑ All Work Surfaces fully finished with approach sides
- ☑ Pedestals ship fully factory assembled

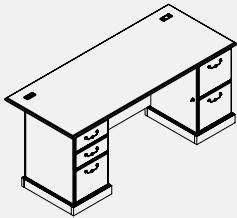
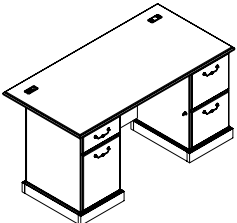
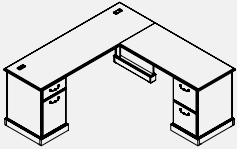
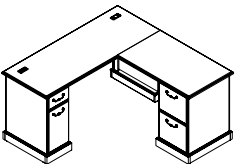
| | Description | Finish | SKU Number | Shpg Wt. (lbs) | Cube (ft.) | UPS/ Fed Ex | List Price |
|---|--|--------------------------------|--------------------------|----------------------------------|-----------------------------------|-------------|------------|
|  | <p>72W x 30D Double Pedestal Desk</p> <ul style="list-style-type: none"> • Will accept 72W Hutch • Includes one 3 Drawer Pedestal • Includes one 2 Drawer Pedestal • Ships in two boxes • All full-extension slide drawers • 72.24"W x 30"D x 30.75"H • Not on GSA Contract | Mocha Cherry Harvest Cherry | 6372MC-03K 6372CS-03K | Box 1 145 Box 2 100 | Box 1 18.8 Box 2 5.8 | Yes | \$1,268.00 |
|  | <p>60W x 30D Double Pedestal Desk</p> <ul style="list-style-type: none"> • Will accept 60W Hutch • Includes one 2 Drawer Storage Pedestal • Includes one 2 Drawer Pedestal • Ships in two boxes • All full-extension slide drawers • 60.79"W x 30"D x 30.75"H • Not on GSA Contract | Mocha Cherry Harvest Cherry | 6360MC-03K 6360CS-03K | Box 1 132 Box 2 87 | Box 1 18.8 Box 2 5 | Yes | \$1,190.00 |
|  | <p>72W x 72D L-Desk</p> <ul style="list-style-type: none"> • Will accept 72W Hutch in two positions • Includes one 2 Drawer Storage Pedestal and one 2 Drawer Pedestal • All full-extension slide drawers • Ships in two boxes • Work Surface 72.25"W x 23.13"D • Return 42.25"W x 24"D • 72.24"W x 72.24"D x 30.75"H • Not on GSA Contract | Mocha Cherry Harvest Cherry | 6310MC-03K 6310CS-03K | Box 1 134 Box 2 145 | Box 1 18.9 Box 2 8.3 | Yes | \$1,358.00 |
|  | <p>60W x 60D L-Desk</p> <ul style="list-style-type: none"> • Will accept 60W Hutch in two positions • Includes one 2 Drawer Storage Pedestal and one 2 Drawer Pedestal • All full-extension slide drawers • Ships in two boxes • Work Surface 60.88"W x 23.13"D • Return 30.88"W x 24"D • 60.79"W x 60.79"D x 30.75"H • Not on GSA Contract | Mocha Cherry Harvest Cherry | 6330MC-03K 6330CS-03K | Box 1 126 Box 2 123 | Box 1 16.7 Box 2 7.1 | Yes | \$1,271.00 |

Syndicate – Work Surfaces (con't)

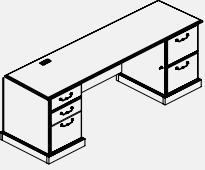
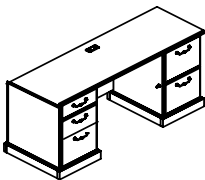
| | Description | Finish | SKU Number | Shpg Wt. (lbs) | Cube (ft.) | UPS/ Fed Ex | List Price |
|--|---|--|----------------------------------|--|--|-------------|-------------------|
|  | <p>72W x 24D Double Pedestal Kneespace Credenza</p> <ul style="list-style-type: none"> • Pedestals ship pre-assembled • Integrated 4-port USB hub • Includes one 3 Drawer Pedestal and one 2 Drawer Pedestal • Accepts 72W Hutch • Ships in two boxes • All full-extension slide drawers • 72.24"W x 21.93"D x 30.75"H • Not on GSA Contract | <p>Mocha Cherry Harvest Cherry</p> | <p>6327MC-03K 6327CS-03K</p> | <p>Box 1 145 Box 2 84</p> | <p>Box 1 18.8 Box 2 5.4</p> | <p>Yes</p> | <p>\$1,248.00</p> |
|  | <p>60W x 24D Double Pedestal Kneespace Credenza</p> <ul style="list-style-type: none"> • Pedestals ship pre-assembled • Integrated 4-port USB hub • Includes one 3 Drawer Pedestal and one 2 Drawer Pedestal • Accepts 60W Hutch • Ships in two boxes • All full-extension slide drawers • 60.79"W x 21.93"D x 30.75"H • Not on GSA Contract | <p>Mocha Cherry Harvest Cherry</p> | <p>6326MC-03K 6326CS-03K</p> | <p>Box 1 145 Box 2 70</p> | <p>Box 1 18.8 Box 2 4.6</p> | <p>Yes</p> | <p>\$1,215.00</p> |

Syndicate – Storage

Hutch Storage

- Aluminum door hardware and edge detail
- Shelves with clipped back corners for easy wire management
- Constructed of 100% thermally fused laminate

Filing

- File drawers accommodate legal, letter, and A4 file sizes and accept hanging file management system
- File drawers utilize full-extension, ball-bearing slides
- Ships fully assembled
- Aluminum door hardware and edge detail
- Constructed of 100% thermally fused laminate

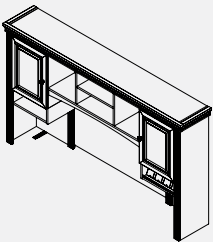
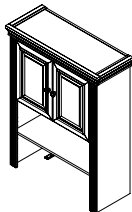
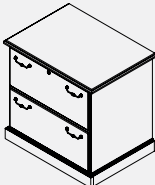
| | Description | Finish | SKU Number | Shpg Wt. (lbs) | Cube (ft.) | UPS/ Fed Ex | List Price |
|---|---|--------------------------------|--------------------------|---------------------------------|-----------------------------------|-------------|------------|
|  | <p>72W Hutch</p> <ul style="list-style-type: none"> • Doors utilize Euro-style hinges • Includes Back Panel • Pre-drilled to accept Task Light accessory • Mounts to either the 72W Double Pedestal Desk or 72W x 72D L-Desk • Convenient charging station for portable devices • Ships in two boxes • 72.01"W x 12.58"D x 41.26"H • Not on GSA Contract | Mocha Cherry Harvest Cherry | 6373MC-03K 6373CS-03K | Box 1 128 Box 2 73 | Box 1 19.5 Box 2 5.9 | Yes | \$903.00 |
|  | <p>30W Lateral File Hutch</p> <ul style="list-style-type: none"> • Mounts to Lateral File • Framed glass doors utilize Euro-style hinges • Adjustable Shelf • 31.81"W x 23.19"D x 30.75"H • Not on GSA Contract | Mocha Cherry Harvest Cherry | 6355MC-03 6355ACS-03 | 82 | 15.8 | Yes | \$490.00 |
|  | <p>30W x 24D 2 Drawer Lateral File</p> <ul style="list-style-type: none"> • Anti-tip safety mechanism • Lockable with single lock • Accepts 30W Lateral File Hutch • 31.81"W x 23.19"D x 30.75"H • Not on GSA Contract | Mocha Cherry Harvest Cherry | 6354MC-03 6354ACS-03 | 140 | 19.7 | Yes | \$755.00 |

Series C Elite



10-Year
Manufacturer's
Warranty

Accessories

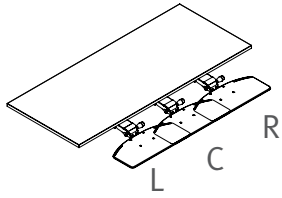

- Underside of Work Surfaces pre-drilled for accessories
- Accepts Articulating Keyboards, Drawers and 3/4 Pedestals
- Work Surfaces 48W and smaller accept Keyboard Trays in center position
- Work Surfaces 60W and larger accept Keyboard Trays and Drawers in left, center or right positions
- Corner Desks and Left or Right L-Bow Desks accept Keyboard Trays in center position only

Sample configurations

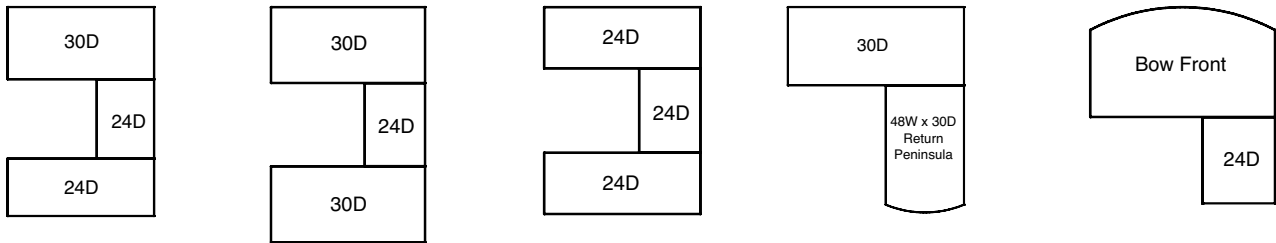

* Recommended Bridge width should be 42" or larger

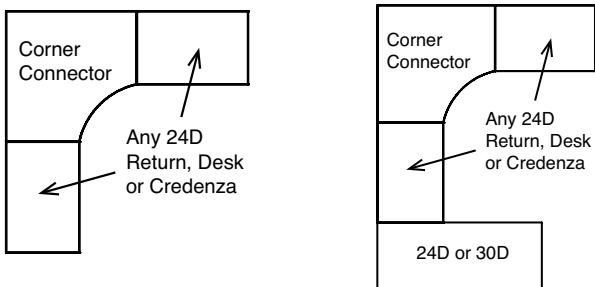

Non-compatible configurations

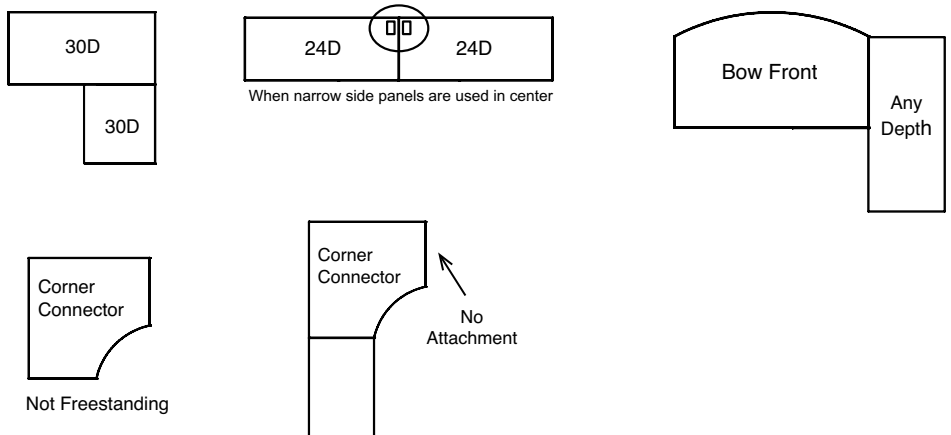

Specification Guide – C-Leg Desks

Accessories

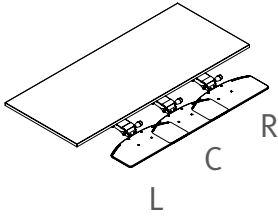

- Underside of Work Surfaces pre-drilled for accessories
- Accepts Articulating Keyboards, Drawers and 3/4 Pedestals
- Work Surfaces 48W and smaller accept Keyboard Trays in center position
- Work Surfaces 60W and larger accept Keyboard Trays and Drawers in left, center, or right positions
- Corner Desks accept Keyboard in center position only. Cannot accept Drawers.

Sample configurations

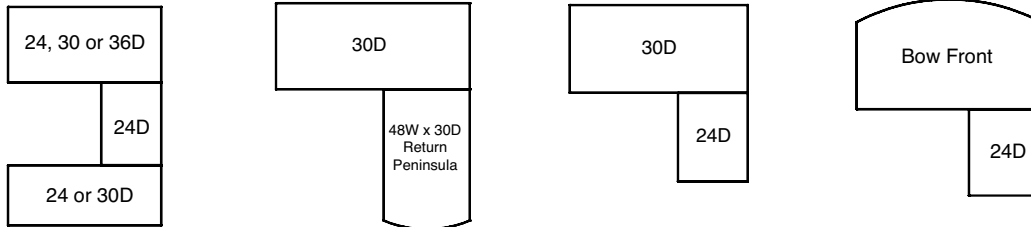

Non-compatible configurations

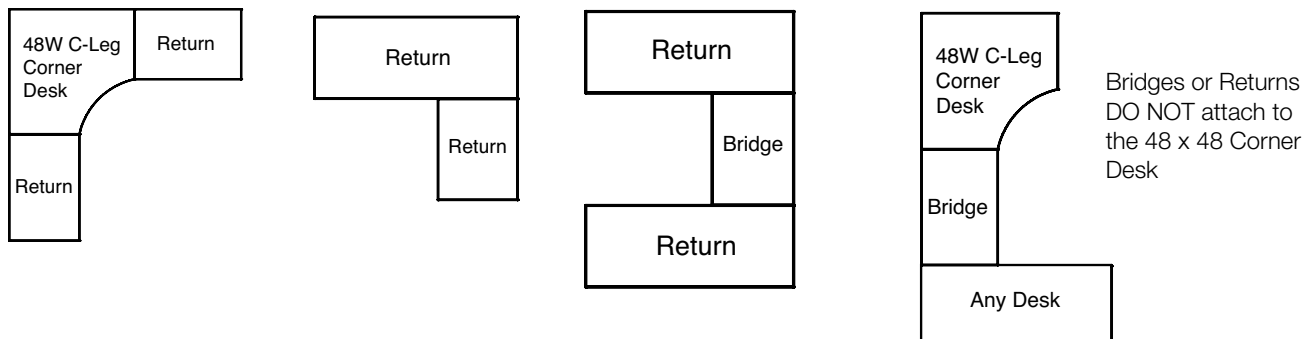

- Corner Desks are freestanding
- Returns and Bridges cannot be attached
- Any 24D C-Leg Desk can be placed on either side of Corner Desk

Specification Guide – Standing Height Desks

Sample configurations

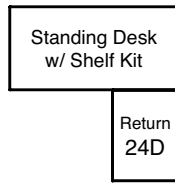
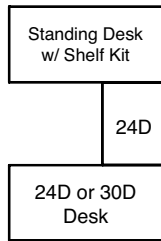

Note: Attaches to Returns and Bridges ONLY when Shelf Kit is used.

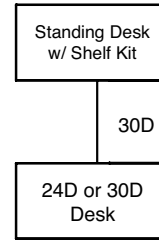

Non-compatible configurations

Specification Guide – Hutches

Sample configurations

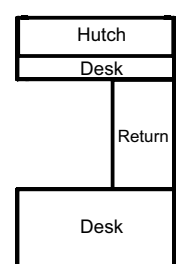
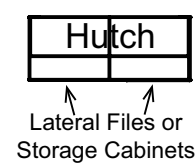
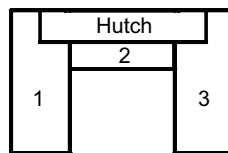
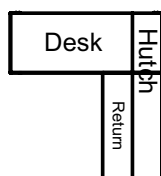
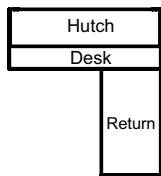

Specification Guide – Reception Shelf

Sample configurations

L-Configuration

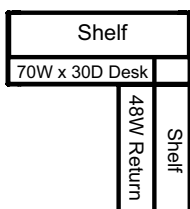

- Attaches with brackets through grommet holes on Work Surface
- Must use 70 x 30 Desk and 48 x 30 Return
- Reception Shelf compatible with Shell Desks only
- C-Leg Desks will not accept Reception Shelf

Straight Configuration

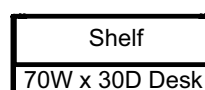

- Attaches with brackets through grommet holes on Work Surface
- Use one portion of Reception Shelf for this configuration

Specification Guide – Pedestals



3/4 Pedestal



16W Mobile
Pedestal



16W
Pedestal











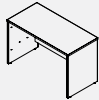

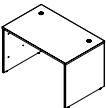

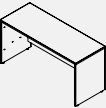

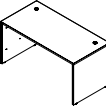
24W
Pedestal

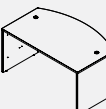

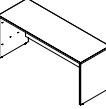

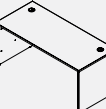





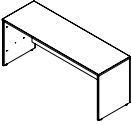

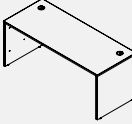

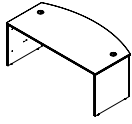

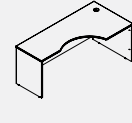
- Mobile Pedestals roll under any Desk, Credenza/Return, Bridge, or Standing Height Desk when used with a Shelf Kit
- 16W Pedestals have no top and must be placed under any Desk, Credenza/Return, Bridge or Standing Height Desk when used with a Shelf Kit
- 24W Pedestals can be placed without their tops under any Desk, Credenza/Return, Bridge, or Standing Height Desk when used with a Shelf Kit. Can be freestanding when used with included tops.
- 3/4 Pedestals must be mounted to either the left or right side of any Desk, Credenza or Return by attaching to a full width side panel and underside of Work Surface. No center placements are permitted.

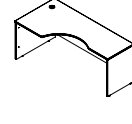
Series C Elite – Desk Shells

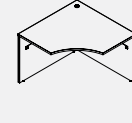
- All Work Surfaces and Leg End Panels are 1" thick for strength and long term use
- Each End Panel has levelers to adjust for uneven floor surfaces (1/2" adjustment range)
- Conceal cords and cables with integrated wire management grommets
- Extended Modesty and Side Panels
- Proven quality constructed of durable, thermally fused laminate for superior resistance to scratches and stains
- Smaller width and depth options for small spaces and home offices
- Desks with wire management grommets can accept monitor arm with post (sold separately)
- New industry standard sizes for design customization

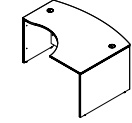
| | Description | Finish | SKU Number | Shpg Wt. (lbs) | Cube (ft.) | UPS/Fed Ex | List Price |
|---|---|-------------------------------|---------------------|----------------|------------|------------|------------|
|  | <p>48W x 24D Desk/Credenza</p> <ul style="list-style-type: none"> • Accepts 30W, 36W, 42W and 48W Bridges, 60W, 66W and 72W Desk/Credenzas • Attaches to Right or Left Corner Module (deep end) or on Left or Right L-Bow Desk • Accepts Keyboard Trays in center position and 3/4 Pedestal in left or right position (sold separately) • Accepts 48W Hutch • 47.60"W x 23.35"D x 29.84"H •  (SIN 711-2) | Hansen Cherry Mocha Cherry | WC24509 WC12909 | 82 | 4.1 | Yes | \$362.00 |
|  | <p>48W x 30D Desk Shell</p> <ul style="list-style-type: none"> • Accepts 30W, 36W, 42W and 48W Bridge>Returns, 60W, 66W and 72W Desk/Credenza>Returns • Accepts Pencil Drawer or Keyboard Trays in center position and 3/4 Pedestal in left or right position • Attaches to 72W x 24/36D Left and Right Corner Desks • Accepts 48W Hutch • 47.68"W x 29.37"D x 29.84"H •  (SIN 711-2) | Hansen Cherry Mocha Cherry | WC24548 WC12948 | 102 | 5.0 | Yes | \$385.00 |
|  | <p>60W x 24D Desk/Credenza</p> <ul style="list-style-type: none"> • Accepts 30W, 36W, 42W and 48W Bridge>Returns, 48W, 60W, 66W and 72W Desk/Credenza>Returns, 60W and 72W Bow Front Desks • Attaches to Right or Left Corner Module (deep end) or on Left or Right L-Bow Desk • Accepts Pencil Drawer or Keyboard Trays in left, center, and right positions and 3/4 Pedestal in left or right position • Accepts 60W Hutch • 59.45"W x 23.35"D x 29.84"H •  (SIN 711-2) | Hansen Cherry Mocha Cherry | WC24561 WC12961 | 116 | 5.3 | Yes | \$391.00 |
|  | <p>60W x 30D Desk Shell</p> <ul style="list-style-type: none"> • Accepts 30W, 36W, 42W and 48W Bridge>Returns, 60W, 66W and 72W Desk/Credenza>Returns • Accepts Pencil Drawer or Keyboard Trays in left, center, or right position and 3/4 Pedestal in left or right position • Attaches to 72W x 24/36D Left and Right Corner Desks • Accepts 60W Hutch • 59.45"W x 29.37"D x 29.84"H •  (SIN 711-2) | Hansen Cherry Mocha Cherry | WC24531 WC12931 | 118 | 4.9 | Yes | \$421.00 |
|  | <p>60W x 36D Bow Front Desk</p> <ul style="list-style-type: none"> • Accepts 30W, 36W, 42W and 48W Bridge>Returns, 60W, 66W and 72W Desk/Credenza>Returns • Accepts Pencil Drawer or Keyboard Trays in left, center, and right position and 3/4 Pedestal in left or right position • Attaches to 72W x 24/36D Left and Right Corner Desks • 59.45"W x 36.06"D x 29.84"H •  (SIN 711-2) | Hansen Cherry Mocha Cherry | WC24505 WC12905 | 127 | 5.6 | Yes | \$502.00 |
|  | <p>66W x 24D Desk Shell</p> <ul style="list-style-type: none"> • Accepts 30W, 36W, 42W and 48W Bridge>Returns, 48W, 60W, and 72W Desk/Credenza>Returns, 60W and 72W Bow Front Desks • Attaches to Right or Left Corner Module (deep end) or on Left or Right L-Bow Desk • Accepts Pencil Drawer or Keyboard Trays in left, center, and right positions and 3/4 Pedestal in left or right position • Accepts 66W Hutch • 65.98"W x 23.35"D x 29.84"H •  (SIN 711-2) | Hansen Cherry Mocha Cherry | WC24569 WC12969 | 118 | 5.3 | Yes | \$424.00 |
|  | <p>66W x 30D Desk Shell</p> <ul style="list-style-type: none"> • Accepts 30W, 36W, 42W and 48W Bridge>Returns, 60W, 66W and 72W Desk/Credenza>Returns • Accepts Pencil Drawer or Keyboard Trays in left, center, and right position and 3/4 Pedestal in left or right position • Attaches to 72W x 24/36D Left and Right Corner Desks • Accepts 66W Hutch • 65.98"W x 29.37"D x 29.80"H •  (SIN 711-2) | Hansen Cherry Mocha Cherry | WC24542 WC12942A | 129 | 5.3 | Yes | \$426.00 |

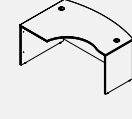









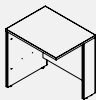

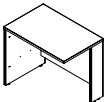

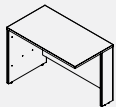
Series C Elite – Desk Shells (con't)

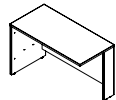
| | Description | Finish | SKU Number | Shpg Wt. (lbs) | Cube (ft.) | UPS/Fed Ex | List Price |
|---|---|-------------------------------|--------------------|----------------|------------|------------|------------|
|  | <p>72W x 24D Desk/Credenza</p> <ul style="list-style-type: none"> • Accepts 30W, 36W, 42W and 48W Bridge>Returns, 48W, 60W, 66W and 72W Desk/Credenza>Returns • Attaches to Right or Left Corner Module (deep end) or on Left or Right L-Bow Desk • Accepts Pencil Drawer or Keyboard Trays in left, center and right positions and 3/4 Pedestal in left or right position • Accepts 72W Hutch • 71.10"W x 23.35"D x 29.84"H •  (SIN 711-2) | Hansen Cherry Mocha Cherry | WC24526 WC12926 | 122 | 5.6 | Yes | \$451.00 |
|  | <p>72W x 30D Desk Shell</p> <ul style="list-style-type: none"> • Accepts 30W, 36W, 42W and 48W Bridge>Returns, 48W, 60W, 66W and 72W Desk/Credenza>Returns • Accepts Pencil Drawer or Keyboard Trays in left, center, and right position and 3/4 Pedestal in left or right position • Attaches to 72W x 24/36D Left and Right Corner Desks • Accepts 72W Hutch • 71.10"W x 29.37"D x 29.84"H •  (SIN 711-2) | Hansen Cherry Mocha Cherry | WC24536 WC12936 | 137 | 5.7 | Yes | \$482.00 |
|  | <p>72W x 36D Bow Front Desk</p> <ul style="list-style-type: none"> • Accepts 30W, 36W, 42W and 48W Bridge>Returns, 48W, 60W, 66W and 72W Desk/Credenza>Returns • Accepts Pencil Drawer or Keyboard Trays in left, center, and right position and 3/4 Pedestal in left or right position • Attaches to 72W x 24/36D Left and Right Corner Desks • 71.02"W x 36.06"D x 29.84"H •  (SIN 711-2) | Hansen Cherry Mocha Cherry | WC24546 WC12946 | 145 | 6.9 | Yes | \$542.00 |
|  | <p>72W x 24 to 36D Right Corner Desk Shell</p> <ul style="list-style-type: none"> • Accepts 30W, 36W, 42W and 48W Bridge>Returns, 48W, 60W, 66W and 72W Desk/Credenza>Returns • Attaches to 48W, 60W, 66W and 72W Desks and 60W and 72W Bow Front Desks • Accepts 72W Hutch, Keyboard Trays in corner position and 3/4 Pedestal in left or right position • 71.02"W x 35.47"D x 29.84"H •  (SIN 711-2) | Hansen Cherry Mocha Cherry | WC24523 WC12923 | 145 | 6.9 | Yes | \$546.00 |
|  | <p>72W x 24 to 36D Left Corner Desk Shell</p> <ul style="list-style-type: none"> • Accepts 30W, 36W, 42W and 48W Bridge>Returns, 48W, 60W, 66W and 72W Desk/Credenza>Returns • Attaches to 48W, 60W, 66W and 72W Desks and 60W and 72W Bow Front Desks • Accepts 72W Hutch, Keyboard Trays in corner position and 3/4 Pedestal in left or right position • 71.02"W x 35.47"D x 29.84"H •  (SIN 711-2) | Hansen Cherry Mocha Cherry | WC24532 WC12932 | 145 | 6.9 | Yes | \$546.00 |
|  | <p>42W Corner Connector</p> <ul style="list-style-type: none"> • Not freestanding. Must be attached at both ends to a Desk/Credenza/Return or Return/Bridge • Attaches to 30W, 36W and 42W Bridge>Returns, 48W Return and Privacy Bridge/Return • Attaches to 60W, 66W and 72W Desk/Credenza/Return • Accepts 72W Hutch when used with 30W Bridge/Return • Accepts Keyboard Trays in center position (sold separately) • 41.65"W x 41.65"D x 29.84"H •  (SIN 711-2) | Hansen Cherry Mocha Cherry | WC24541 WC12941 | 116 | 5.7 | Yes | \$461.00 |
|  | <p>60W x 43D RH L-Bow Desk</p> <ul style="list-style-type: none"> • Accepts any Credenza or Return/Bridge on right side • Accepts Keyboard Tray or Articulating Keyboard Trays in corner position • 58.86"W x 42.87"D x 29.84"H •  (SIN 711-2) | Hansen Cherry Mocha Cherry | WC24522 WC12922 | 132 | 6.3 | Yes | \$499.00 |
|  | <p>60W x 43D LH L-Bow Desk</p> <ul style="list-style-type: none"> • Accepts any Credenza or Return/Bridge on left side • Accepts Keyboard Trays in corner position • 58.86"W x 42.87"D x 29.84"H •  (SIN 711-2) | Hansen Cherry Mocha Cherry | WC24533 WC12933 | 132 | 6.3 | Yes | \$499.00 |

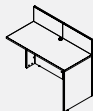
Series C Elite – Bridge/Returns

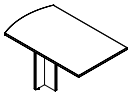

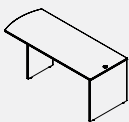



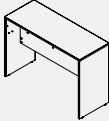

Proven quality constructed of durable, thermally fused laminate for superior resistance to scratches and stains

Not freestanding, must be attached to another Work Surface

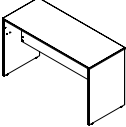
| | Description | Finish | SKU Number | Shpg Wt. (lbs) | Cube (ft.) | UPS/ Fed Ex | List Price |
|---|---|-------------------------------|--------------------|----------------|------------|-------------|------------|
|  | <p>30W x 24D Bridge/Return</p> <ul style="list-style-type: none"> Attaches to 48W, 60W, 66W and 72W Desk Shells or Credenzas, 60W or 72W Bow Front Desks Attaches to Right or Left Corner Module (deep end) or on Left or Right L-Bow Desk Must be attached to another Work Surface Accepts Keyboard Trays (sold separately) in center position and 3/4 Pedestal in left or right position 29.65"W x 23.35"D x 29.84"H  (SIN 711-2) | Hansen Cherry Mocha Cherry | WC24507 WC12907 | 63 | 2.9 | Yes | \$217.00 |
|  | <p>36W x 24D Bridge/Return</p> <ul style="list-style-type: none"> Attaches to 48W, 60W, 66W and 72W Desk Shells or Credenzas, 60W or 72W Bow Front Desks Attaches to Right or Left Corner Module (deep end) or on Left or Right L-Bow Desk Must be attached to another Work Surface Accepts Keyboard Trays (sold separately) in center position and 3/4 Pedestal in left or right position 35.43"W x 23.35"D x 29.84"H  (SIN 711-2) | Hansen Cherry Mocha Cherry | WC24518 WC12918 | 70 | 3.4 | Yes | \$217.00 |
|  | <p>42W x 24D Bridge/Return</p> <ul style="list-style-type: none"> Attaches to 48W, 60W, 66W and 72W Desk Shells or Credenzas, 60W or 72W Bow Front Desks Attaches to Right or Left Corner Module (deep end) or on Left or Right L-Bow Desk Must be attached to another Work Surface Accepts Keyboard Trays in center position and 3/4 Pedestal in left or right position 41.65"W x 23.35"D x 29.84"H  (SIN 711-2) | Hansen Cherry Mocha Cherry | WC24544 WC12944 | 77 | 3.9 | Yes | \$257.00 |
|  | <p>48W x 24D Bridge/Return</p> <ul style="list-style-type: none"> Attaches to 48W, 60W, 66W and 72W Desk Shells or Credenzas, 60W or 72W Bow Front Desks Attaches to Right or Left Corner Module (deep end) or on Left or Right L-Bow Desk Must be attached to another Work Surface Accepts Keyboard Trays in center position and 3/4 Pedestal in left or right position 47.68"W x 23.35"D x 29.84"H  (SIN 711-2) | Hansen Cherry Mocha Cherry | WC24524 WC12924 | 84 | 4.3 | Yes | \$263.00 |
|  | <p>48W x 24D Privacy Bridge/Return</p> <ul style="list-style-type: none"> Attaches to 48W, 60W, 66W and 72W Desk Shells or Credenzas, 60W or 72W Bow Front Desks Attaches to Right or Left Corner Module (deep end) or on Left or Right L-Bow Desk Must be attached to another Work Surface Optional Tackboard available (sold separately) 47.60"W x 23.35"D x 40.18"H  (SIN 711-2) | Hansen Cherry Mocha Cherry | WC24508 WC12908 | 116 | 5.5 | Yes | \$392.00 |
|  | <p>48W x 30D Peninsula Return</p> <ul style="list-style-type: none"> Attaches to 48W, 60W, 66W and 72W Desks Shells and Credenzas or 60W and 72W Bow Front Desks to form a L-Workstation 47.68"W x 29.37"D x 29.69"H  (SIN 711-2) | Hansen Cherry Mocha Cherry | WC24570 WC12970 | 60 | 3.6 | Yes | \$279.00 |
|  | <p>72W x 30D Peninsula</p> <ul style="list-style-type: none"> Attaches to 48W, 60W, 66W and 72W Desks, Credenzas and Returns 71.02"W x 29.37"D x 29.76"H  (SIN 711-2) | Hansen Cherry Mocha Cherry | WC24571 WC12971 | 113 | 6.0 | Yes | \$466.00 |

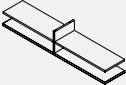

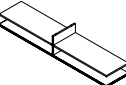







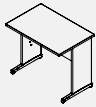

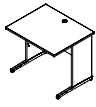
Series C Elite – Table Desks

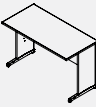
- ☑ Durable, thermally fused laminate Work Surface features superior resistance to scratches and stains
- ☑ All Work Surfaces and leg panels are one inch thick for strength and long term use
- ☑ A flexible, healthy, and ergonomic solution for today's work environments
- ☑ 41" High Work Surfaces allow user to comfortably stand while working
- ☑ Shelving allows attachment of Bridge/Returns to mix Sit-to-Stand functionality
- ☑ Available with shelving for privacy/storage or open for barstool height meeting/work table
- ☑ Low-cost method for those that need to sit and stand throughout the day
- ☑ Available in two sizes (72W x 30D, 60W x 24D)
- ☑ For freestanding (not placed against a wall) Desks using Pedestals underneath, order 2 Shelf Kits

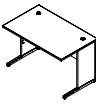

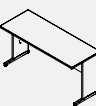

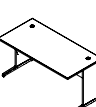



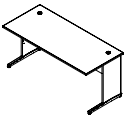

| | Description | Finish | SKU Number | Shpg Wt. (lbs) | Cube (ft.) | UPS/ Fed Ex | List Price |
|---|---|-------------------------------|----------------------|----------------------------|------------------------------|-------------|------------|
|  | 60W x 24D Standing Desk <ul style="list-style-type: none"> • Accepts 16W and 24W Pedestals with tops removed or two Standing Desk Shelf Kits (one on each side of Desk) • 59.45"W x 23.35"D x 41.18"H •  (SIN 711-2) | Hansen Cherry Mocha Cherry | WC24515 WC12915 | 110 | 5.2 | Yes | \$543.00 |
|  | 72W x 30D Standing Desk <ul style="list-style-type: none"> • Accepts 16W and 24W Pedestal with tops removed and Standing Table Desk Shelf Kits (one on each side of Desk) • 71.02"W x 29.37"D x 40.67"H •  (SIN 711-2) | Hansen Cherry Mocha Cherry | WC24575K WC12975K | Box 1 64 Box 2 89 | Box 1 3.0 Box 2 4.6 | Yes | \$723.00 |
|  | 60W Standing Desk Shelf Kit <ul style="list-style-type: none"> • Attaches under 60W Standing Table Desk • Two adjustable shelves • 57.20"W x 11.24"D x 11.34"H •  (SIN 711-2) | Hansen Cherry Mocha Cherry | WC24516 WC12916 | 37 | 2.5 | Yes | \$254.00 |
|  | 72W Standing Desk Shelf Kit <ul style="list-style-type: none"> • Attaches under 72W Standing Table Desk • Two adjustable shelves • 68.78"W x 14.13"D x 11.34"H •  (SIN 711-2) | Hansen Cherry Mocha Cherry | WC24580 WC12980 | 55 | 3.5 | Yes | \$321.00 |

Series C Elite – C-Leg Desks

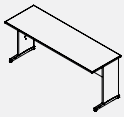
- Clean, contemporary design and uniform color
- Lightly scaled and open with added legroom
- New 30D and 24D Work Surfaces provide greater work style variations
- New Bridge and Return options for efficient Corner, L and U-shaped configurations
- Thermally fused laminate for superior resistance to scratches and stains
- All Work surfaces and Leg End Panels are 1" thick for strength and long term use
- Each foot has levelers to adjust for uneven floor surfaces

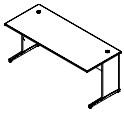

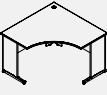



| | Description | Finish | SKU Number | Shpg Wt. (lbs) | Cube (ft.) | UPS/Fed Ex | List Price |
|---|---|-------------------------------|--------------------|----------------|------------|------------|------------|
|  | 36W x 24D C-Leg Desk <ul style="list-style-type: none"> • Accepts 36W Hutch • Works with 3/4 Pedestal in either a left or right position • Accepts Keyboard Tray accessory in a center position (sold separately) • 35.4"W x 23.39"D x 29.70"H •  (SIN 711-2) | Hansen Cherry Mocha Cherry | WC24529 WC12929 | 53 | 2.9 | Yes | \$321.00 |
|  | 36W x 30D C-Leg Desk <ul style="list-style-type: none"> • Accepts 36W Hutch • Works with 3/4 Pedestal in either a left or right position • Accepts Keyboard Tray accessory in a center position (sold separately) • 35.43"W x 29.37"D x 29.37"H •  (SIN 711-2) | Hansen Cherry Mocha Cherry | WC24530 WC12930 | 67 | 3.2 | Yes | \$326.00 |
|  | 48W x 24D C-Leg Desk <ul style="list-style-type: none"> • Accepts 48W Hutch • Works with 3/4 Pedestal in either a left or right position • Accepts Keyboard Tray accessory in a center position (sold separately) • 47.60"W x 23.35"D x 29.53"H •  (SIN 711-2) | Hansen Cherry Mocha Cherry | WC24549 WC12949 | 68 | 3.7 | Yes | \$331.00 |
|  | 48W x 30D C-Leg Desk <ul style="list-style-type: none"> • Accepts 48W Hutch • Works with 3/4 Pedestal in either a left or right position • Accepts Keyboard Tray accessory in a center position (sold separately) • 47.60"W x 29.37"D x 29.53"H •  (SIN 711-2) | Hansen Cherry Mocha Cherry | WC24550 WC12950 | 78 | 4.1 | Yes | \$362.00 |
|  | 60W x 24D C-Leg Desk <ul style="list-style-type: none"> • Accepts 60W Hutch • Works with 3/4 Pedestal in either a left or right position • Accepts Keyboard Tray accessory in a left, center, or right position (sold separately) • 59.45"W x 23.35"D x 29.53"H •  (SIN 711-2) | Hansen Cherry Mocha Cherry | WC24563 WC12963 | 89 | 4.2 | Yes | \$388.00 |
|  | 60W x 30D C-Leg Desk <ul style="list-style-type: none"> • Accepts 60W Hutch • Works with 3/4 Pedestal in either a left or right position • Accepts Keyboard Tray accessory in a left, center, or right position (sold separately) • 59.45"W x 29.37"D x 29.53"H •  (SIN 711-2) | Hansen Cherry Mocha Cherry | WC24564 WC12964 | 95 | 5.1 | Yes | \$413.00 |

Series C Elite – C-Leg Desks (con't)

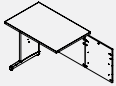
| | Description | Finish | SKU Number | Shpg Wt. (lbs) | Cube (ft.) | UPS/ Fed Ex | List Price |
|---|--|-------------------------------|--------------------|----------------|------------|-------------|------------|
|  | <p>60W x 36D C-Leg Bow Front Desk</p> <ul style="list-style-type: none"> • Accepts 36W and 42W C-Leg Returns to form a L-Workstation or a 42W C-Leg Bridge to create a U-Workstation • Accepts Keyboard Tray accessory in a left, center, or right position (sold separately) • 59.45"W x 34.06"D x 29.53"H •  (SIN 711-2) | Hansen Cherry Mocha Cherry | WC24565 WC12965 | 103 | 5.8 | Yes | \$502.00 |
|  | <p>66W x 30D C-Leg Desk</p> <ul style="list-style-type: none"> • Accepts 66W Hutch • Works with 3/4 Pedestal in either a left or right position • Accepts Keyboard Tray accessory in a left, center, or right position (sold separately) • 65.98"W x 29.37"D x 29.53"H •  (SIN 711-2) | Hansen Cherry Mocha Cherry | WC24567 WC12967 | 102 | 5.6 | Yes | \$435.00 |
|  | <p>72W x 24D C-Leg Desk</p> <ul style="list-style-type: none"> • Accepts 72W Hutch • Works with 3/4 Pedestal in either a left or right position • Accepts Keyboard Tray accessory in a left, center, or right position (sold separately) • 71.02"W x 23.35"D x 29.53"H •  (SIN 711-2) | Hansen Cherry Mocha Cherry | WC24573 WC12973 | 97 | 4.9 | Yes | \$419.00 |
|  | <p>72W x 30D C-Leg Desk</p> <ul style="list-style-type: none"> • Accepts 72W Hutch • Works with 3/4 Pedestal in either a left or right position • Accepts Keyboard Tray accessory in a left, center, or right position (sold separately) • 71.02"W x 29.37"D x 29.53"H •  (SIN 711-2) | Hansen Cherry Mocha Cherry | WC24574 WC12974 | 109 | 6.0 | Yes | \$450.00 |
|  | <p>48W C-Leg Corner Desk</p> <ul style="list-style-type: none"> • Accepts 48W Corner Hutch or 48W Hutch on side • Accepts Keyboard Tray accessory in a corner position (sold separately) • 47.17"W x 47.17"D x 29.53"H •  (SIN 711-2) | Hansen Cherry Mocha Cherry | WC24551 WC12951 | 115 | 5.9 | Yes | \$497.00 |

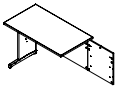

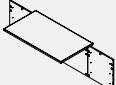



Series C Elite – C-Leg Bridges/Returns

- Durable, thermally fused laminate Work Surface features superior resistance to scratches and stains
- All Work Surfaces and Leg End Panels are 1" thick for strength and long-term use
- Not freestanding, must be attached to another Work Surface

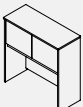

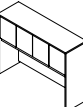

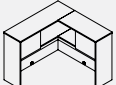





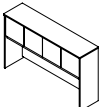

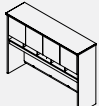

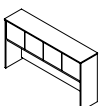

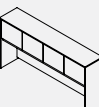
| | Description | Finish | SKU Number | Shpg Wt. (lbs) | Cube (ft.) | UPS/ Fed Ex | List Price |
|---|--|-------------------------------|--------------------|----------------|------------|-------------|------------|
|  | 36W x 24D C-Leg Return <ul style="list-style-type: none"> • Must be attached to another Work Surface • Works with 3/4 Pedestal in either a left or right position • Attaches to any 24D or 30D C-Leg Desk to create a U-Workstation • 35.43"W x 23.35"D x 28.27"H •  (SIN 711-2) | Hansen Cherry Mocha Cherry | WC24535 WC12935 | 62 | 3.2 | Yes | \$285.00 |
|  | 42W x 24D C-Leg Return <ul style="list-style-type: none"> • Must be attached to another work surface • Attaches to any 24D or 30D C-Leg Desk to create an L-Workstation • Works with 3/4 Pedestal in either a left or right position • 41.50"W x 23.35"D x 27.95"H •  (SIN 711-2) | Hansen Cherry Mocha Cherry | WC24540 WC12940 | 68 | 3.7 | Yes | \$305.00 |
|  | 42W x 24D C-Leg Bridge <ul style="list-style-type: none"> • Must be attached to another work surface • Attaches to any 24D or 30D C-Leg Desk to create a U-Workstation • 41.50"W x 23.23"D x 20.67"H •  (SIN 711-2) | Hansen Cherry Mocha Cherry | WC24543 WC12943 | 53 | 2.6 | Yes | \$223.00 |

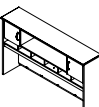
Series C Elite – Hutches

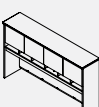
- All doors feature Euro-style hinges
- Coordinating Tackboards available (sold separately)
- Hutches to fit all desks and 36W Storage pieces

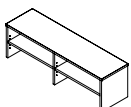
| | Description | Finish | SKU Number | Shpg Wt. (lbs) | Cube (ft.) | UPS/ Fed Ex | List Price |
|---|---|-------------------------------|--------------------|----------------|------------|-------------|------------|
|  | 36W Hutch <ul style="list-style-type: none"> • Mounts on 36W or larger Desks, 36W Storage Cabinet and 36W 2 Drawer Lateral File • Two doors conceal open storage compartment • Accepts one Task Light (sold separately) • 35.35"W x 10.59"D x 36.02"H •  (SIN 711-2) | Hansen Cherry Mocha Cherry | WC24537 WC12937 | 71 | 3.4 | Yes | \$404.00 |
|  | 48W Hutch <ul style="list-style-type: none"> • Mounts on 48W or larger Desk, Credenza or Return • Four doors conceal open storage compartment • Accepts one Task Light (sold separately) • 47.09"W x 14.53"D x 36.02"H •  (SIN 711-2) | Hansen Cherry Mocha Cherry | WC24547 WC12947 | 98 | 4.5 | Yes | \$481.00 |
|  | 48W Corner Hutch <ul style="list-style-type: none"> • Mounts on 48W Corner Desk • Two doors conceal open storage compartment • Accepts two Task Lights (sold separately) • 47.09"W x 47.09"D x 36.06"H •  (SIN 711-2) | Hansen Cherry Mocha Cherry | WC24545 WC12945 | 135 | 6.2 | Yes | \$725.00 |

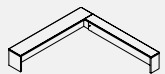









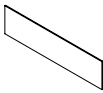

Series C Elite – Hutches (con't)

| | Description | Finish | SKU Number | Shpg Wt. (lbs) | Cube (ft.) | UPS/ Fed Ex | List Price |
|---|--|-------------------------------|----------------------|----------------|------------|-------------|------------|
|  | <p>60W Hutch</p> <ul style="list-style-type: none"> Mounts on 60W or larger Desk, Credenza or Return Four doors conceal open storage compartment Accepts two Task Lights (sold separately) 58.70"W x 14.53"D x 36.02"H  (SIN 711-2) | Hansen Cherry Mocha Cherry | WC24579 WC12979 | 105 | 5.2 | Yes | \$549.00 |
|  | <p>60W Hutch (4-Door) with Work-in-Progress</p> <ul style="list-style-type: none"> Mounts onto the 60W or larger Desk, Credenza or Return Four doors conceal open storage compartment Accepts two Task Lights (sold separately) 58.86"W x 15.35"D x 43.01"H  (SIN 711-2) | Hansen Cherry Mocha Cherry | WC24462K WC12962K | 152 | 5.2 | Yes | \$609.00 |
|  | <p>66W Hutch</p> <ul style="list-style-type: none"> Mounts on 66W or larger Desk, Credenza or Return Four doors conceal open storage compartment Accepts two Task Lights (sold separately) 64.72"W x 14.53"D x 36.02"H  (SIN 711-2) | Hansen Cherry Mocha Cherry | WC24568 WC12968 | 113 | 5.0 | Yes | \$611.00 |
|  | <p>72W Hutch</p> <ul style="list-style-type: none"> Mounts on 72W or larger Desk, Credenza or Return Four doors conceal open storage compartment Accepts two Task Lights (sold separately) 70.94"W x 14.53"D x 36.02"H  (SIN 711-2) | Hansen Cherry Mocha Cherry | WC24578 WC12978 | 121 | 6.1 | Yes | \$664.00 |
|  | <p>72W Hutch (2-Door) with Work-in-Progress</p> <ul style="list-style-type: none"> 71.02"W x 15.35"D x 43.01"H Mounts on 72W or larger Desk, Credenza or Return Two doors conceal open storage compartment Accepts two Task Lights (sold separately)  (SIN 711-2) | Hansen Cherry Mocha Cherry | WC24466K WC12966K | 175 | 6.2 | Yes | \$738.00 |
|  | <p>72W Hutch (4-Door) with Work-in-Progress</p> <ul style="list-style-type: none"> 71.02"W x 15.35"D x 43.01"H Mounts on 72W Desk Shell, 72W Credenza Shell, RH/LH Corner Module, two 36W 2 Drawer Lateral Files placed side-by-side, or one 2 Drawer Lateral File placed adjacent to the deep end of a Corner Module Accepts two Task Lights (sold separately)  (SIN 711-2) | Hansen Cherry Mocha Cherry | WC24477K WC12977K | 181 | 6.2 | Yes | \$738.00 |
|  | <p>45W Desk Top Organizer</p> <ul style="list-style-type: none"> Mounts on 60W, 66W or 72W Desk and Credenza Two adjustable or removeable shelves 45.39"W x 12.64"D x 13.82"H  (SIN 711-2) | Hansen Cherry Mocha Cherry | WC24510 WC12910 | 41 | 1.9 | Yes | \$285.00 |
|  | <p>Reception L-Shelf</p> <ul style="list-style-type: none"> Mounts on 72W Desk Shell with 48W Return/Bridge Front gallery alone will mount on 72W Desk Shell Assembles right or left-handed 76.89"W x 71.02"D x 13.88"H  (SIN 711-2) | Hansen Cherry Mocha Cherry | WC24476 WC12976 | 82 | 3.1 | Yes | \$482.00 |

Series C Elite – Tackboards

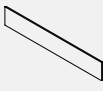
- Tackboard covered in commercial-grade upholstery fabric
- Easily attaches to the Hutch with included clips & screws

- Convenient surface for posting messages, memos, and reminders

| | Description | Finish | SKU Number | Shpg Wt. (lbs) | Cube (ft.) | UPS/ Fed Ex | List Price |
|---|---|--------------|------------|----------------|------------|-------------|------------|
|  | 72W Hutch Tackboard • 68.19"W x 0.51"D x 15.51"H •  (SIN 711-2) | Lyric Sundew | WCTB72LS | 11 | 1.8 | Yes | \$150.00 |
|  | 66W Hutch Tackboard • 61.97"W x 0.51"D x 15.51"H •  (SIN 711-2) | Lyric Sundew | WCTB66LS | 10 | 1.7 | Yes | \$140.00 |
|  | 60W Hutch Tackboard • 55.94"W x 0.51"D x 15.51"H •  (SIN 711-2) | Lyric Sundew | WCTB60LS | 9 | 1.5 | Yes | \$129.00 |
|  | 48W Hutch Tackboard • 44.33"W x 0.51"D x 15.51"H •  (SIN 711-2) | Lyric Sundew | WCTB48LS | 8 | 1.2 | Yes | \$109.00 |
|  | 48W Privacy/Return Tackboard • 46.57"W x 0.51"D x 7.64"H •  (SIN 711-2) | Lyric Sundew | WCPT48LS | 5 | 0.7 | Yes | \$83.00 |
|  | 36W Hutch Tackboard • 32.60"W x 0.51"D x 15.51"H •  (SIN 711-2) | Lyric Sundew | WCTB36LS | 6 | 0.9 | Yes | \$98.00 |

Series C Elite – Storage

File and Pedestal Construction









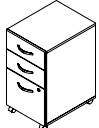

- ☑ All top surfaces and end panels are 1" thick for durability and strength
- ☑ Includes Brushed Nickel finish drawer pulls
- ☑ Drawer interiors finished in Black
- ☑ Case exterior finish matches Desk End Panels
- ☑ Includes face front lock with interchangeable core in lower drawer that secures both the lower and upper drawer
- ☑ All file drawers equipped to accommodate hanging folders

Lateral Files



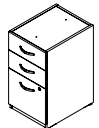

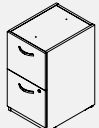
- ☑ File drawers accommodate legal, letter, and A4 file sizes
- ☑ Lateral File drawers glide on full-extension, ball-bearing slides
- ☑ Interlocking drawer mechanism on Lateral File prevents both drawers from opening at the same time
- ☑ All pieces in collection ship keyed alike, additional cores available

2 Drawer and 3 Drawer Mobile Pedestals, 3/4 Pedestal

- ☑ Face front lock with interchangeable core secures lower and center drawer in 3 Drawer Mobile Pedestal
- ☑ All file drawers extend on full-extension, ball-bearing slides
- ☑ All box drawers utilize 3/4-extension, ball-bearing slides
- ☑ Dual-wheeled, hooded casters: two swivel, two fixed on Mobile Pedestals

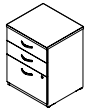
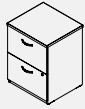
| | Description | Finish | SKU Number | Shpg Wt. (lbs) | Cube (ft.) | UPS/ Fed Ex | List Price |
|---|--|-------------------------------|------------------------|----------------|------------|-------------|------------|
|  | 3/4 Pedestal <ul style="list-style-type: none"> • Mounts on right or left side of any Desk Shell, Credenza, or Return against any full width end panel • 15.51"W x 20.16"D x 20.00"H •  (SIN 711-3) | Hansen Cherry Mocha Cherry | WC24590SU WC12990SU | 47 | 2.5 | Yes | \$374.00 |
|  | 16W 3 Drawer Mobile Pedestal <ul style="list-style-type: none"> • Rolls under Desk surface or use freestanding • 15.71"W x 20.16"D x 27.87"H •  (SIN 711-3) | Hansen Cherry Mocha Cherry | WC24553SU WC12953SU | 62 | 3.2 | Yes | \$464.00 |
|  | 16W 2 Drawer Mobile Pedestal <ul style="list-style-type: none"> • Rolls under Desk surface or use freestanding • 15.71"W x 20.16"D x 27.87"H •  (SIN 711-3) | Hansen Cherry Mocha Cherry | WC24552SU WC12952SU | 63 | 3.2 | Yes | \$452.00 |
|  | 16W 3 Drawer Pedestal <ul style="list-style-type: none"> • Intended for use beneath Desk surface • 15.75"W x 20.35"D x 28.84"H •  (SIN 711-3) | Hansen Cherry Mocha Cherry | WC24555SU WC12955SU | 70 | 3.5 | Yes | \$497.00 |
|  | 16W 2 Drawer Pedestal <ul style="list-style-type: none"> • Intended for use beneath Desk surface • 15.75"W x 20.35"D x 28.84"H •  (SIN 711-3) | Hansen Cherry Mocha Cherry | WC24556SU WC12956SU | 70 | 3.5 | Yes | \$481.00 |

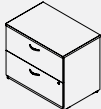
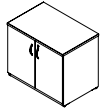
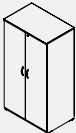
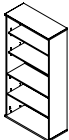

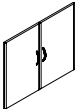



Series C Elite – Storage (con't)

| | Description | Finish | SKU Number | Shpg Wt. (lbs) | Cube (ft.) | UPS/ Fed Ex | List Price |
|---|---|-------------------------------|--------------------------|-----------------------------|------------------------------|-------------|------------|
|  | <p>24W 3 Drawer Pedestal</p> <ul style="list-style-type: none"> Use with finished top or without top under any Desk or Credenza Shell 22.60"W x 20.59"D x 29.84"H GSA APPROVED (SIN 711-3) | Hansen Cherry Mocha Cherry | WC24501SU WC12901SU | 97 | 4.7 | Yes | \$621.00 |
|  | <p>24W 2 Drawer Pedestal</p> <ul style="list-style-type: none"> Use with finished top or without top under any Desk or Credenza Shell 22.60"W x 20.59"D x 29.84"H GSA APPROVED (SIN 711-3) | Hansen Cherry Mocha Cherry | WC24502SU WC12902SU | 97 | 4.7 | Yes | \$600.00 |
|  | <p>24W Pedestal Piler/File</p> <ul style="list-style-type: none"> Use with finished top or without top under any Desk or Credenza Shell Four storage cubbies with two adjustable shelves 22.60"W x 20.59"D x 29.84"H GSA APPROVED (SIN 711-3) | Hansen Cherry Mocha Cherry | WC24503SU WC12903SU | 98 | 4.7 | Yes | \$569.00 |
|  | <p>36W Lateral File</p> <ul style="list-style-type: none"> Accepts 36W Hutch Two adjacent units accept 72W Hutch 35.67"W x 23.35"D x 29.84"H GSA APPROVED (SIN 711-3) | Hansen Cherry Mocha Cherry | WC24554CSU WC12954CSU | 127 | 6.1 | No | \$729.00 |
|  | <p>36W Storage Cabinet</p> <ul style="list-style-type: none"> Accepts 36W Hutch Two adjacent units accept 72W Hutch One adjustable shelf 35.67"W x 23.35"D x 29.84"H GSA APPROVED (SIN 711-3) | Hansen Cherry Mocha Cherry | WC24598SU WC12998SU | 111 | 6.1 | Yes | \$595.00 |
|  | <p>36W Storage Wardrobe Tower</p> <ul style="list-style-type: none"> Full width coat rod One fixed shelf and two adjustable shelves 35.67"W x 23.35"D x 65.98"H GSA APPROVED (SIN 711-3) | Hansen Cherry Mocha Cherry | WC24557K WC12957K | Box 1 93 Box 2 105 | Box 1 4.4 Box 2 4.4 | Yes | \$827.00 |
|  | <p>36W 5 Shelf Bookcase</p> <ul style="list-style-type: none"> 35.71"W x 15.35"D x 72.80"H GSA APPROVED (SIN 711-2) | Hansen Cherry Mocha Cherry | WC24414 WC12914 | 116 | 5.0 | Yes | \$390.00 |
|  | <p>18W 5 Shelf Bookcase</p> <ul style="list-style-type: none"> Accepts one door from Half-Height Door Kit in lower position, hinged either side 17.83"W x 15.35"D x 72.80"H GSA APPROVED (SIN 711-2) | Hansen Cherry Mocha Cherry | WC24412 WC12912 | 89 | 4.0 | Yes | \$287.00 |
|  | <p>Half Height Door Kit</p> <ul style="list-style-type: none"> Includes two non-handed doors 35.47"W x .75"D x 29.25"H GSA APPROVED (SIN 711-2) | Hansen Cherry Mocha Cherry | WC24411 WC12911 | 26 | 1.0 | Yes | \$121.00 |

Series C Elite – Tables

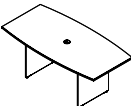
- ☑ Work Surfaces are constructed of 100% thermally fused laminate with durable edge band to resist scratches and stains
- ☑ All Work Surfaces and leg end panels are 1" thick

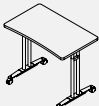
- ☑ Each foot has levelers to adjust for uneven floor surfaces

| | Description | Finish | SKU Number | Shpg Wt. (lbs) | Cube (ft.) | UPS/ Fed Ex | List Price |
|---|--|-------------------------------|--------------------------|----------------|------------|-------------|------------|
|  | <p>42W Round Conference Table</p> <ul style="list-style-type: none"> • Comfortable seating for four people • 41.38"W x 41.38"D x 29.66"H •  (SIN 711-11) | Hansen Cherry Mocha Cherry | 99TB42RHC 99TB42RMR | 80 | 4.5 | Yes | \$459.00 |
|  | <p>72W x 36W Boat Top Conference Table</p> <ul style="list-style-type: none"> • Comfortable seating for four to six people • 35.98"W x 71.54"D x 28.65"H •  (SIN 711-11) | Hansen Cherry Mocha Cherry | 99TB7236HC 99TB7236MR | 117 | 7.1 | Yes | \$716.00 |
|  | <p>36W x 22D Adjustable Height Mobile Table</p> <ul style="list-style-type: none"> • Provides a mobile height adjustable Work Surface • Table adjusts to 8 height settings from 26.63" to 34.63" • Mobile on lockable casters • 35.61"W x 21.97"D x 34.70"H •  (SIN 711-11) | Hansen Cherry Mocha Cherry | WC24482 WC12982 | 58 | 5.7 | Yes | \$440.00 |









Series C

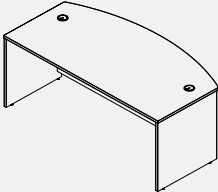

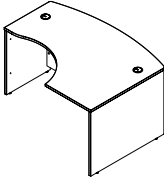

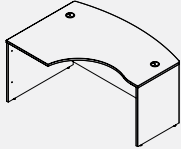

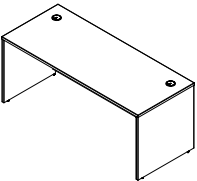



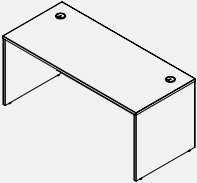

10-Year
Manufacturer's
Warranty

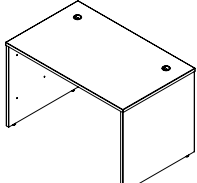
Series C – Work Surfaces and Extensions

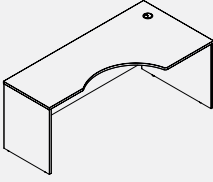

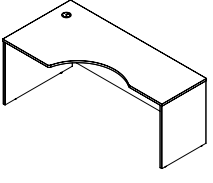

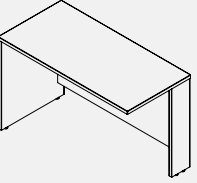

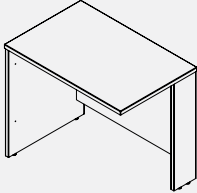

- ☑ Durable, thermally fused laminate Work Surfaces feature superior resistance to scratches and stains
- ☑ All Work Surfaces and Leg End Panels are 1" thick
- ☑ Each End Panel has levelers to adjust for uneven floor surfaces (1/2" adjustment range)
- ☑ All Desk Work Surfaces feature wire management grommets which can accept Monitor Arm with Post (sold separately)
- ☑ Dual-cavity wire channel mounts to Modesty Panels in two convenient locations; accommodates electrical cords and standard size power strips
- ☑ Snap down wire clips on channels hold wires in place
- ☑ Desk surfaces are 30D
- ☑ Credenza surfaces are 24D

| | Description | Finish | SKU Number | Shpg Wt. (lbs) | Cube (ft.) | UPS/ Fed Ex | List Price |
|---|---|---|--|----------------|------------|-------------|------------|
|  | <p>72W x 36D Bow Front Desk Shell</p> <ul style="list-style-type: none"> • Accepts Pencil Drawer or Keyboard Trays in center, right or left positions • Accepts Corner Module, Return/Bridge or Credenza on right or left side • Accepts two 3/4 Pedestals, 2 Drawer or 3 Drawer Mobile Pedestals • 71.1"W x 36.06"D x 29.84"H •  (SIN 711-2) | <p>Mocha Cherry Hansen Cherry Mahogany Auburn Maple Light Oak Warm Oak Natural Cherry</p> | <p>WC12946 WC24446 WC36746 WC48546 WC60346 WC67546 WC72446</p> | 142 | 5.6 | Yes | \$542.00 |
|  | <p>60W x 43D RH L-Bow Desk Shell</p> <ul style="list-style-type: none"> • Accepts any Credenza or Return/Bridge on right side • Accepts Keyboard Tray or Articulating Keyboard Trays in corner position • 58.86"W x 42.87"D x 29.84"H •  (SIN 711-2) | <p>Mocha Cherry Hansen Cherry Mahogany Auburn Maple Light Oak Warm Oak Natural Cherry</p> | <p>WC12922 WC24422 WC36722 WC48522 WC60322 WC67522 WC72422</p> | 127 | 5.4 | Yes | \$499.00 |
|  | <p>60W x 43D LH L-Bow Desk Shell</p> <ul style="list-style-type: none"> • Accepts any Credenza or Return/Bridge on left side • Accepts Keyboard Trays in corner position • 58.86"W x 42.87"D x 29.84"H •  (SIN 711-2) | <p>Mocha Cherry Hansen Cherry Mahogany Auburn Maple Light Oak Warm Oak Natural Cherry</p> | <p>WC12933 WC24433 WC36733 WC48533 WC60333 WC67533 WC72433</p> | 127 | 5.4 | Yes | \$499.00 |
|  | <p>72W x 30D Desk Shell</p> <ul style="list-style-type: none"> • Accepts 72W Hutch • Accepts Pencil Drawer or Keyboard Trays in center, right, or left position • Accepts Corner Module, Return/Bridge or Credenza on right or left side • Accepts two 3/4 Pedestals, 2 Drawer or 3 Drawer Mobile Pedestals • 71.1"W x 29.37"D x 29.84"H •  (SIN 711-2) | <p>Mocha Cherry Hansen Cherry Mahogany Auburn Maple Light Oak Warm Oak Natural Cherry</p> | <p>WC12936 WC24436 WC36736 WC48536 WC60336 WC67536 WC72436</p> | 136 | 4.5 | Yes | \$482.00 |

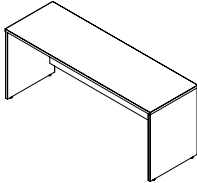
Series C – Work Surfaces and Extensions (con't)

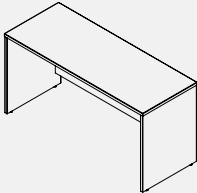
| | Description | Finish | SKU Number | Shpg Wt. (lbs) | Cube (ft.) | UPS/Fed Ex | List Price |
|---|---|---|---|----------------|------------|------------|------------|
|  | <p>66W x 30D Desk Shell</p> <ul style="list-style-type: none"> • Accepts Corner Module, Return/Bridge or Credenza on right or left side • Accepts two 3/4 Pedestals, 2 Drawer or 3 Drawer Mobile Pedestal • Accepts Pencil Drawer or Keyboard Trays • Accepts 60W Hutch (4-Door) • 65.98"W x 29.37"D x 29.84"H •  (SIN 711-2) | <p>Mocha Cherry Hansen Cherry Mahogany Auburn Maple Light Oak Warm Oak Natural Cherry</p> | <p>WC12942A WC24442A WC36742A WC48542A WC60342A WC67542A WC72442A</p> | 128 | 4.5 | Yes | \$426.00 |
|  | <p>48W x 30D Desk Shell</p> <ul style="list-style-type: none"> • Accepts optional Universal Keyboard Shelf, Pencil Drawer, Articulating Keyboard Tray, Multi-Purpose drawer—center position only • Accepts 3 Drawer, 2 Drawer, or 3/4 Pedestal • 47.68"W x 29.37"D x 29.84"H •  (SIN 711-2) | <p>Mocha Cherry Hansen Cherry Mahogany Natural Cherry</p> | <p>WC12948 WC24448 WC36748 WC72448</p> | 102 | 3.7 | Yes | \$385.00 |
|  | <p>72W x 36D RH Corner Module</p> <ul style="list-style-type: none"> • Accepts Credenza or Return/Bridge on right (deep) side • Attaches to left front edge of 72W Bow Front Desk Shell, 72W or 66W Desk Shell • Accepts 72W Hutch • Accepts Articulating Keyboard Tray or Universal Keyboard Tray in corner position • 71.1"W x 35.47"D x 29.84"H •  (SIN 711-2) | <p>Mocha Cherry Hansen Cherry Mahogany Auburn Maple Light Oak Warm Oak Natural Cherry</p> | <p>WC12923 WC24423 WC36723 WC48523 WC60323 WC67523 WC72423</p> | 135 | 5.2 | Yes | \$546.00 |
|  | <p>72W x 36D LH Corner Module</p> <ul style="list-style-type: none"> • Accepts Credenza or Return/Bridge on left (deep) side • Attaches to right front edge of 72W Bow Front Desk Shell, 72W or 66W Desk Shell • Accepts 72W Hutch • Accepts Articulating Keyboard Trays or Universal Keyboard Shelf in corner position • 71.1"W x 35.47"D x 29.84"H •  (SIN 711-2) | <p>Mocha Cherry Hansen Cherry Mahogany Auburn Maple Light Oak Warm Oak Natural Cherry</p> | <p>WC12932 WC24432 WC36732 WC48532 WC60332 WC67532 WC72432</p> | 135 | 5.2 | Yes | \$546.00 |
|  | <p>48W x 24D Return/Bridge</p> <ul style="list-style-type: none"> • Attaches to 72W Bow Front Desk Shell, 72W or 66W Desk Shell or Credenza on right or left • Attaches to Right or Left Corner Module (deep end) or on Right or Left L-Bow Desk • Serves as a Bridge between two Desks • Must be attached to another Work Surface • Accepts Keyboard Trays or Pencil Drawer in center • Accepts 3/4 Pedestal • Accommodates 2 Drawer or 3 Drawer Pedestals • 47.68"W x 23.35"D x 29.84"H •  (SIN 711-2) | <p>Mocha Cherry Hansen Cherry Mahogany Auburn Maple Light Oak Warm Oak Natural Cherry</p> | <p>WC12924 WC24424 WC36724 WC48524 WC60324 WC67524 WC72424</p> | 79 | 2.9 | Yes | \$263.00 |

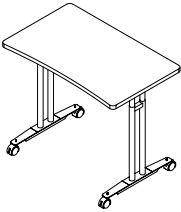
Series C – Work Surfaces and Extensions (con't)

| | Description | Finish | SKU Number | Shpg Wt. (lbs) | Cube (ft.) | UPS/ Fed Ex | List Price |
|---|--|---|--|----------------|------------|-------------|------------|
|  | <p>36W x 24D Return/Bridge</p> <ul style="list-style-type: none"> Attaches to 72W Bow Front Desk Shell, 72W or 66W Desk Shell or Credenza on right or left Attaches to Right or Left Corner Module (deep end) or on RH or LH 60W x 43D L-Bow Desk Serves as a Bridge between two Desks Must be attached to another Work Surface Accepts 3/4 Pedestal Accommodates 2 Drawer or 3 Drawer Mobile Pedestals 35.43"W x 23.35"D x 29.84"H  (SIN 711-2) | <p>Mocha Cherry Hansen Cherry Mahogany Auburn Maple Light Oak Warm Oak Natural Cherry</p> | <p>WC12918 WC24418 WC36718 WC48518 WC60318 WC67518 WC72418</p> | 66 | 2.3 | Yes | \$217.00 |
|  | <p>72W x 24D Credenza Shell</p> <ul style="list-style-type: none"> Attaches to Desks on right or left with one full-depth End Panel and one narrow support Panel included Freestanding when two full-depth End Panels are installed Accepts 72W Hutch Accepts Pencil Drawer or Keyboard Trays in center, right, or left positions Accommodates 2 Drawer or 3 Drawer Pedestals 71.1"W x 23.35"D x 29.84"H  (SIN 711-2) | <p>Mocha Cherry Hansen Cherry Mahogany Auburn Maple Light Oak Warm Oak Natural Cherry</p> | <p>WC12926 WC24426 WC36726 WC48526 WC60326 WC67526 WC72426</p> | 115 | 4.2 | Yes | \$451.00 |
|  | <p>60W x 24D Credenza Shell</p> <ul style="list-style-type: none"> Attaches to Desks on right or left with one full-depth End Panel and one narrow support Panel included Accepts 60W Hutch or two 30W Hutches Accepts Pencil Drawer or Keyboard Trays in center, right, or left Accommodates 2 Drawer or 3 Drawer Mobile Pedestals 59.45"W x 23.35"D x 29.84"H  (SIN 711-2) | <p>Mocha Cherry Hansen Cherry Mahogany Auburn Maple Light Oak Warm Oak Natural Cherry</p> | <p>WC12961 WC24461 WC36761 WC48561 WC60361 WC67561 WC72461</p> | 105 | 3.5 | Yes | \$391.00 |
|  | <p>36W x 22D Adjustable Height Mobile Table</p> <ul style="list-style-type: none"> Provides a mobile and height adjustable Work Surface Table adjusts to 8 height settings from 26.63" to 34.63" Mobile on lockable casters 35.61"W x 21.97"D x 34.7"H  (SIN 711-2) | <p>Mocha Cherry Hansen Cherry Mahogany Auburn Maple Light Oak Warm Oak Natural Cherry</p> | <p>WC12982 WC24482 WC36782 WC48582 WC60382 WC67582 WC72482</p> | 53 | 4.7 | Yes | \$440.00 |







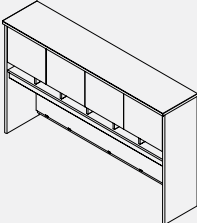

Series C – Hutch Storage

☑ All Hutches include fully finished Back Panel and fabric-covered Tackboard

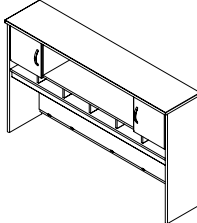

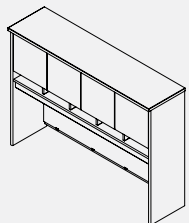

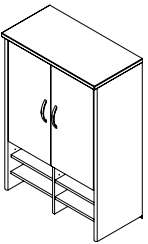
☑ Overall height of Desk/Hutch unit is 72"

☑ Mounts conveniently to desking, Lateral Files, or Storage Cabinets

☑ Euro-style hinges

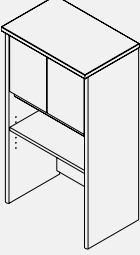
| | Description | Finish | SKU Number | Shpg Wt. (lbs) | Cube (ft.) | UPS/ Fed Ex | List Price |
|---|---|---|--|----------------|------------|-------------|------------|
|  | <p>72W Hutch (4 Door)</p> <ul style="list-style-type: none"> Mounts on 72W Desk Shell, 72W Credenza Shell, RH/LH Corner Module, two 36W 2 Drawer Lateral Files placed side-by-side, or one 2 Drawer Lateral File placed adjacent to the deep end of a Corner Module Accepts two Task Lights 71.02"W x 15.35"D x 43.01"H  (SIN 711-2) | <p>Mocha Cherry Hansen Cherry Mahogany Auburn Maple Light Oak Warm Oak Natural Cherry</p> | <p>WC12977 WC24477 WC36777 WC48577 WC60377 WC67577 WC72477</p> | 181 | 6.2 | No | \$738.00 |
|  | <p>72W Hutch (2 Door)</p> <ul style="list-style-type: none"> Mounts on 72W Desk Shell, 72W Credenza Shell, RH/LH Corner Module, two 36W 2 Drawer Lateral Files placed side-by-side, or one 2 Drawer Lateral File placed adjacent to the deep end of a Corner Module Accepts two Task Lights 71.02"W x 15.35"D x 43.01"H  (SIN 711-2) | <p>Mocha Cherry Hansen Cherry Mahogany Auburn Maple Light Oak Warm Oak Natural Cherry</p> | <p>WC12966 WC24466 WC36766 WC48566 WC60366 WC67566 WC72466</p> | 175 | 6.2 | No | \$738.00 |
|  | <p>60W Hutch (4 Door)</p> <ul style="list-style-type: none"> Mounts on 60W Credenza Shell, 36W 2 Drawer Lateral File, and end of Return/Bridge or Credenza Accepts two Task Lights 58.86"W x 15.35"D x 43.01"H  (SIN 711-2) | <p>Mocha Cherry Hansen Cherry Mahogany Auburn Maple Light Oak Warm Oak Natural Cherry</p> | <p>WC12962 WC24462 WC36762 WC48562 WC60362 WC67562 WC72462</p> | 152 | 5.2 | No | \$609.00 |
|  | <p>30W Hutch</p> <ul style="list-style-type: none"> Mounts on 30W Storage Two adjustable shelves in concealed area provide storage flexibility Includes open work-in-process compartments to help organize papers Two adjustable shelves in lower area 29.45"W x 15.35"D x 43.01"H  (SIN 711-2) | <p>Mocha Cherry Hansen Cherry Mahogany Auburn Maple Light Oak Warm Oak Natural Cherry</p> | <p>WC12997 WC24497 WC36797 WC48597 WC60397 WC67597 WC72497</p> | 95 | 3.2 | Yes | \$391.00 |

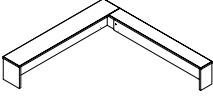
Series C – Hutch Storage (con't)

| | Description | Finish | SKU Number | Shpg Wt. (lbs) | Cube (ft.) | UPS/ Fed Ex | List Price |
|---|---|---|--|----------------|------------|-------------|------------|
|  | <p>24W Hutch</p> <ul style="list-style-type: none"> • Mounts on 24W Piler/Filer • Provides concealed storage behind two doors • One adjustable shelf • Wire pass-through allows wires to be fed between the 24W Piler/Filer and the Hutch Back Panel • 23.54"W x 15.35"D x 43.01"H •  (SIN 711-2) | <p>Mocha Cherry Hansen Cherry Mahogany Auburn Maple Light Oak Warm Oak Natural Cherry</p> | <p>WC12906 WC24406 WC36706 WC48506 WC60306 WC67506 WC72406</p> | 76 | 3 | Yes | \$446.00 |
|  | <p>Reception L-Shelf</p> <ul style="list-style-type: none"> • Mounts on 72W Desk Shell with 48W Return/Bridge • Front gallery alone will mount on 72W Desk Shell • Assembles right or left-handed • 76.89"W x 71.02"D x 13.88"H •  (SIN 711-2) | <p>Mocha Cherry Hansen Cherry Mahogany Auburn Maple Light Oak Warm Oak Natural Cherry</p> | <p>WC12976 WC24476 WC36776 WC48576 WC60376 WC67576 WC72476</p> | 82 | 3.1 | Yes | \$482.00 |

Series C – Filing

File and Pedestal Construction

- Includes Brushed Nickel finish drawer pulls
- Drawer interiors finished in Black
- Case exterior finish matches Desk End Panels
- Includes face front lock with interchangeable core in lower drawer that secures both the lower and upper drawer
- All file drawers equipped to accommodate hanging folders







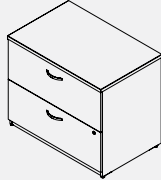

Lateral Files

- File drawers accommodate legal, letter and A4 file sizes
- Lateral File drawers glide on full-extension, ball-bearing slides

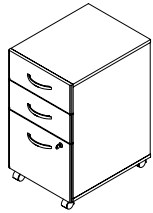
- Interlocking drawer mechanism on Lateral File prevents both drawers from opening at the same time
- All pieces in collection ship keyed alike, additional cores available

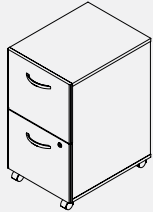
Mobile Pedestals

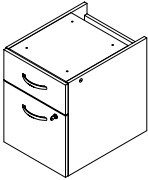
- Dual-wheeled, hooded casters: two swivel, two fixed
- Face front lock with interchangeable core secures lower and center drawer in Mobile Pedestal
- All file drawers extend on full-extension, ball-bearing slides
- All box drawers utilize 3/4-extension, ball-bearing slides

| | Description | Finish | SKU Number | Shpg Wt. (lbs) | Cube (ft.) | UPS/Fed Ex | List Price |
|---|--|--|--|----------------|------------|------------|------------|
|  | <p>36W x 24D 2 Drawer Lateral File (Assembled)</p> <ul style="list-style-type: none"> • Top shelf matches Desk Work Surface in height • Accepts 72W Hutch when adjacent to deep end of RH/LH Corner Module • Accepts 72W Hutch when placed next to another 36W 2 Drawer Lateral File • 35.67"W x 23.35"D x 29.84"H •  (SIN 711-3) | Mocha Cherry Hansen Cherry Mahogany Auburn Maple Light Oak Warm Oak Natural Cherry | WC12954CSU WC24454CSU WC36754CSU WC48554CSU WC60354CSU WC67554CSU WC72454CSU | 145 | 19.0 | NO | \$729.00 |
|  | <p>3 Drawer Mobile Pedestal (Assembled)</p> <ul style="list-style-type: none"> • Rolls under any Desk Shell or Credenza Shell • 15.71"W x 20.16"D x 27.87"H •  (SIN 711-3) | Mocha Cherry Hansen Cherry Mahogany Auburn Maple Light Oak Warm Oak Natural Cherry | WC12953SU WC24453SU WC36753SU WC48553SU WC60353SU WC67553SU WC72453SU | 66 | 6.8 | Yes | \$464.00 |
|  | <p>2 Drawer Mobile Pedestal (Assembled)</p> <ul style="list-style-type: none"> • Rolls under any Desk Shell or Credenza Shell • 15.71"W x 20.16"D x 27.87"H •  (SIN 711-3) | Mocha Cherry Hansen Cherry Mahogany Auburn Maple Light Oak Warm Oak Natural Cherry | WC12952SU WC24452SU WC36752SU WC48552SU WC60352SU WC67552SU WC72452SU | 63 | 6.8 | Yes | \$452.00 |
|  | <p>3/4 Pedestal (Assembled)</p> <ul style="list-style-type: none"> • Mounts in right or left side of 72W Bow Front Desk Shell, 72W Desk Shell, and 66W Desk Shell • Mounts against full width End Panel of 48W Return/Bridge and 36W Return/Bridge • 15.51"W x 20.16"D x 20"H •  (SIN 711-3) | Mocha Cherry Hansen Cherry Mahogany Auburn Maple Light Oak Warm Oak Natural Cherry | WC12990SU WC24490SU WC36790SU WC48590SU WC60390SU WC67590SU WC72490SU | 56 | 5.7 | Yes | \$374.00 |







Series C – Storage

Storage Cabinet and Piler/Filer

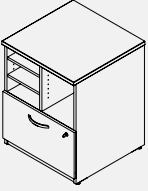

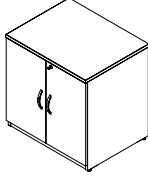

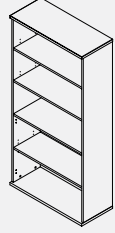
- Grommet in back panel for wire access in Storage Cabinet
- Adjustable leveling glides
- Adjustable shelving Bookcase construction

Bookcase Construction



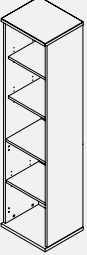

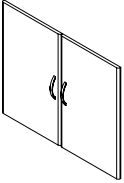
- Three adjustable shelves
- Two fixed shelves
- Optional door for Single Bookcase hinged on right or left side in lower position
- Bookcases match Hutch height and depth
- Doors feature Euro-style hinges

| | Description | Finish | SKU Number | Shpg Wt. (lbs) | Cube (ft.) | UPS/Fed Ex | List Price |
|---|---|---|--|----------------|------------|------------|------------|
|  | <p>24W x 24D Piler/Filer</p> <ul style="list-style-type: none"> • Accepts 24W Hutch • Locks for privacy • Two adjustable/removable shelves • 23.54"W x 23.35"D x 29.84"H •  (SIN 711-3) | <p>Mocha Cherry Hansen Cherry Mahogany Auburn Maple Light Oak Warm Oak Natural Cherry</p> | <p>WC12904 WC24404 WC36704 WC48504 WC60304 WC67504 WC72404</p> | 94 | 3.7 | Yes | \$506.00 |
|  | <p>30W x 24D Storage Cabinet</p> <ul style="list-style-type: none"> • Accepts 30W Hutch • Two adjacent units accept 60W Hutch (4 Door) • Locks for privacy • One adjustable shelf (11 position options) • 29.45"W x 23.35"D x 29.84"H •  (SIN 711-3) | <p>Mocha Cherry Hansen Cherry Mahogany Auburn Maple Light Oak Warm Oak Natural Cherry</p> | <p>WC12996A WC24496A WC36796A WC48596A WC60396A WC67596 WC72496A</p> | 97 | 3.3 | Yes | \$391.00 |
|  | <p>36W x 16D 5 Shelf Bookcase</p> <ul style="list-style-type: none"> • Accepts Half-Height Door Kit in lower position • Double Bookcase shelves tested to accommodate up to 102 lbs. each • One fixed shelf and three adjustable shelves • 35.71"W x 15.35"D x 72.8"H •  (SIN 711-2) | <p>Mocha Cherry Hansen Cherry Mahogany Auburn Maple Light Oak Warm Oak Natural Cherry</p> | <p>WC12914 WC24414 WC36714 WC48514 WC60314 WC67514 WC72414</p> | 113 | 3.5 | Yes | \$390.00 |

Series C – Storage (con't)

| | Description | Finish | SKU Number | Shpg Wt. (lbs) | Cube (ft.) | UPS/ Fed Ex | List Price |
|---|--|---|--|----------------|------------|-------------|------------|
|  | <p>18W x 16D 5 Shelf Bookcase</p> <ul style="list-style-type: none"> Accepts one door from Half-Height Door Kit in lower position, hinged either side Single Bookcase shelves tested to accommodate up to 48 lbs. each One fixed shelf and three adjustable shelves 17.83"W x 15.35"D x 72.8"H  (SIN 711-2) | <p>Mocha Cherry Hansen Cherry Mahogany Auburn Maple Light Oak Warm Oak Natural Cherry</p> | <p>WC12912 WC24412 WC36712 WC48512 WC60312 WC67512 WC72412</p> | 87 | 3.1 | Yes | \$287.00 |
|  | <p>Half-Height Door Kit (2-Doors)</p> <ul style="list-style-type: none"> Set mounts on 36W 5 Shelf Bookcase in lower position Mounts one each on 18W 5 Shelf Bookcase Includes two non-handed doors 35.47"W x 0.75"D x 29.25"H  (SIN 711-2) | <p>Mocha Cherry Hansen Cherry Mahogany Auburn Maple Light Oak Warm Oak Natural Cherry</p> | <p>WC12911 WC24411 WC36711 WC48511 WC60311 WC67511 WC72411</p> | 26 | 1.0 | Yes | \$121.00 |

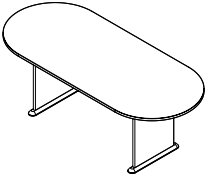
Series C – Conference Tables

| | Description | Finish | SKU Number | Shpg Wt. (lbs) | Cube (ft.) | UPS/ Fed Ex | List Price |
|---|--|--|---|----------------|------------|-------------|------------|
|  | <p>42 Round Conference Table</p> <ul style="list-style-type: none"> Comfortable seating for four people Stable X panel base Levelers installed All bases are Graphite Gray 41.38"W x 41.38"D x 29.8"H  (SIN 711-11) | <p>Mocha Cherry Hansen Cherry Mahogany Light Oak Warm Oak Natural Cherry</p> | <p>TB12942A TB90442A TB36742A TB64342A TB67542 TB57442</p> | 76 | 3.1 | Yes | \$401.00 |
|  | <p>82W x 35D Racetrack Conference Table</p> <ul style="list-style-type: none"> Comfortable seating for six people Stable panel base Levelers installed All bases are Graphite Gray 81.54"W x 34.49"D x 29.76"H  (SIN 711-11) | <p>Mocha Cherry Hansen Cherry Mahogany Light Oak Warm Oak Natural Cherry</p> | <p>TR12984A TR90484A TR36784A TR64384A TR67584 TR57484A</p> | 120 | 5.1 | Yes | \$679.00 |



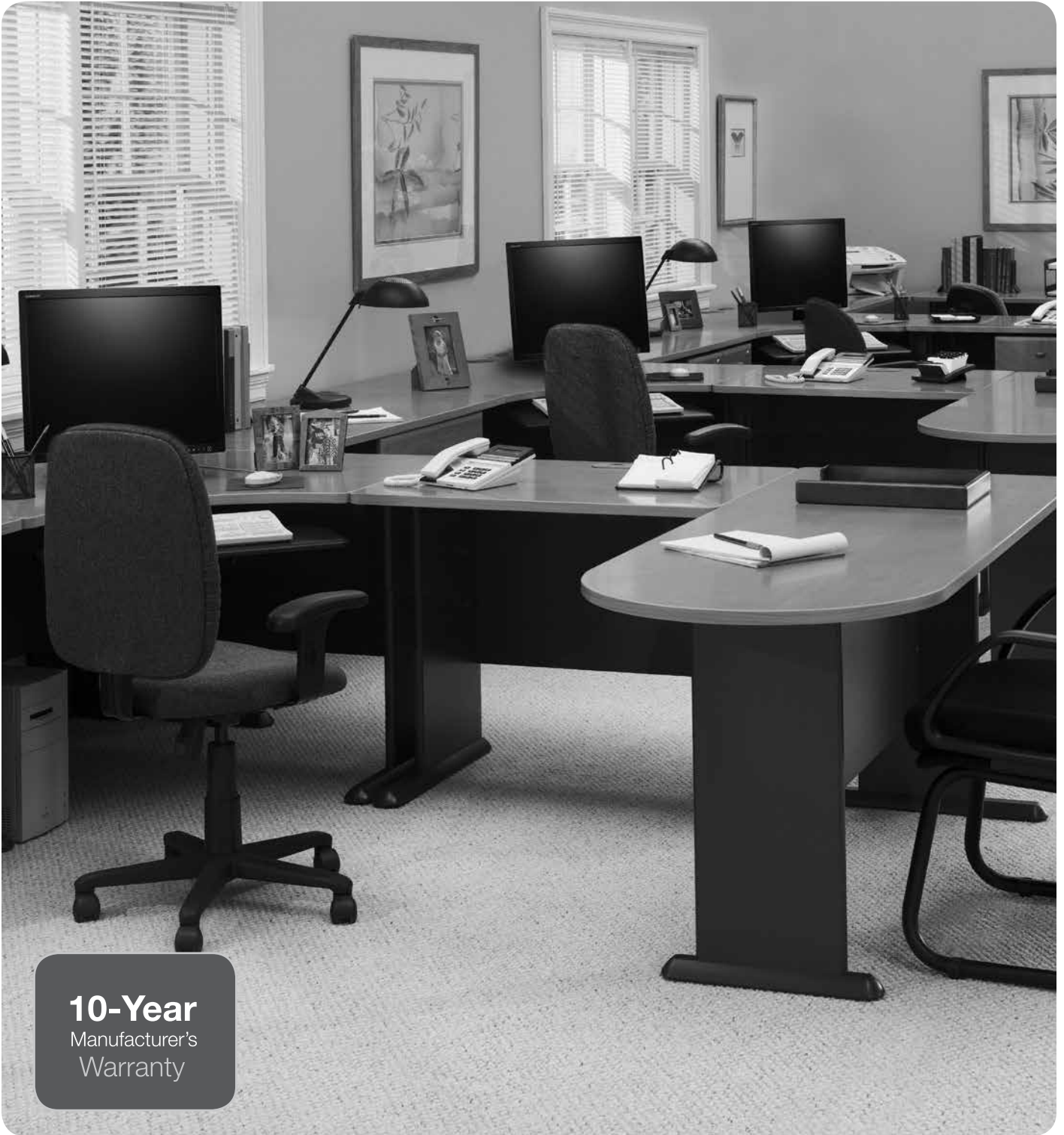





Series A

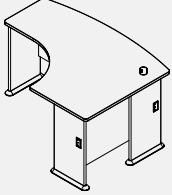

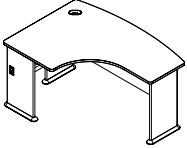

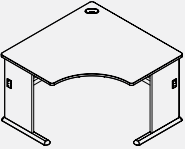

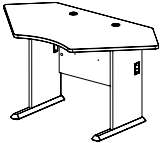

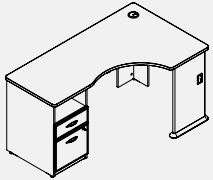

10-Year
Manufacturer's
Warranty

Series A – Work Surfaces

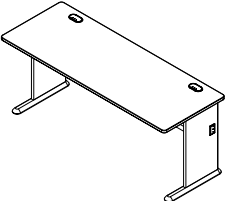

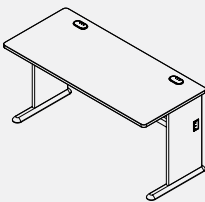

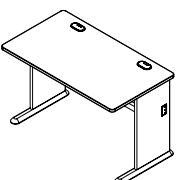

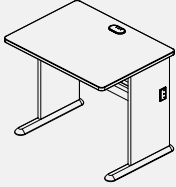

- ☑ Durable, thermally fused laminate Work Surfaces feature superior resistance to scratches and stains
- ☑ All Work Surfaces and Leg End Panels are 1" thick
- ☑ Straight Work Surfaces are 27D
- ☑ Molded plastic feet with encapsulated steel armature
- ☑ All Desk Work Surfaces feature wire management grommets which can accept Monitor Arm with Post accessory (sold separately)
- ☑ Legs have wire management grommets to accommodate wiring between Work Surfaces
- ☑ Dual-cavity wire channel mounts to Modesty Panels in two convenient locations
- ☑ Snap down wire clips on channels hold wires in place
- ☑ Each foot has levelers to adjust for uneven floor surfaces

| | Description | Finish | SKU Number | Shpg Wt. (lbs) | Cube (ft.) | UPS/ Fed Ex | List Price |
|---|--|---|--|----------------|------------|-------------|------------|
|  | 60W x 44D RH L-Bow Desk <ul style="list-style-type: none"> • Accepts Keyboard Trays in corner position • Cannot accept Mobile Pedestal underneath • 59.29"W x 43.31"D x 29.8"H •  (SIN 711-2) | Beech Pewter Sienna Walnut Natural Cherry Light Oak Slate Hansen Cherry | WC14322 WC14522 WC25522 WC57422 WC64322 WC84822 WC94422 | 118 | 5.5 | Yes | \$499.00 |
|  | 60W x 44D LH L-Bow Desk <ul style="list-style-type: none"> • Accepts Keyboard Trays in corner position • Cannot accept Mobile Pedestal underneath • 59.29"W x 43.31"D x 29.8"H •  (SIN 711-2) | Beech Pewter Sienna Walnut Natural Cherry Light Oak Slate Hansen Cherry | WC14333 WC14533 WC25533 WC57433 WC64333 WC84833 WC94433 | 118 | 5.5 | Yes | \$499.00 |
|  | 48W Corner Desk <ul style="list-style-type: none"> • Accepts Articulating Keyboard Trays or Universal Keyboard Shelf • Accepts 48W Corner Hutch or 48W Hutch on one side • 47.17"W x 47.17"D x 29.8"H •  (SIN 711-2) | Beech Pewter Sienna Walnut Natural Cherry Light Oak Slate Hansen Cherry | WC14366 WC14566 WC25566 WC57466 WC64366 WC8427A WC90466A | 113 | 4.7 | Yes | \$482.00 |
|  | 42W Corner Desk <ul style="list-style-type: none"> • Accepts Articulating Keyboard Trays or Universal Keyboard Shelf • Accepts 42W Corner Hutch • 41.34"W x 41.34"D x 29.8"H •  (SIN 711-2) | Beech Pewter Sienna Walnut Natural Cherry Light Oak Slate Hansen Cherry | WC14342 WC14542 WC25542 WC57442 WC64342 WC84842 WC94442 | 72 | 3.8 | Yes | \$414.00 |

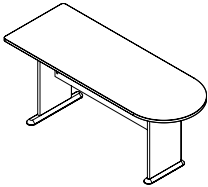
Series A – Work Surfaces (con't)

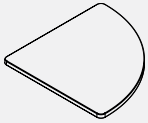
| | Description | Finish | SKU Number | Shpg Wt. (lbs) | Cube (ft.) | UPS/ Fed Ex | List Price |
|---|---|--|--|----------------|------------|-------------|------------|
|  | <p>Single Pedestal Corner Desk</p> <ul style="list-style-type: none"> • Contains box/file drawer • File drawer utilizes a full-extension, ball-bearing slide • Sturdy 1" thick thermally fused laminate Work Surface • Durable 2.0 mm thick edgeband resists dents • Contains wire management • 70.91"W x 35.98"D x 29.8"H •  (SIN 711-2) | <p>Beech Pewter Sienna Walnut Natural Cherry Light Oak Slate Hansen Cherry</p> | <p>WC14328PA WC14528PA WC25528PA WC57428PA WC64328PA WC84828PA WC94428PA</p> | 141 | 5.8 | Yes | \$581.00 |
|  | <p>72W Desk</p> <ul style="list-style-type: none"> • Accepts Keyboard Trays or Pencil Drawer at right, left, or center • Accepts up to four Mobile Pedestals underneath • Accepts one Mobile Pedestal placed on right or left with Pencil Drawer or Keyboard Tray mounted on opposite side • Accepts 72W Hutch • 71.54"W x 26.81"D x 29.8"H •  (SIN 711-2) | <p>Beech Pewter Sienna Walnut Natural Cherry Light Oak Slate Hansen Cherry</p> | <p>WC14372 WC14572 WC25572 WC57472 WC64372 WC84872 WC94472</p> | 102 | 4 | Yes | \$500.00 |
|  | <p>60W Desk</p> <ul style="list-style-type: none"> • Accepts Keyboard Trays or Pencil Drawer at center, right, or left • Accepts up to three Mobile Pedestals underneath • Accepts one Mobile Pedestal placed on right or left with Pencil Drawer or Keyboard Tray mounted on opposite side • Accepts 60W Hutch • 59.57"W x 26.81"D x 29.8"H •  (SIN 711-2) | <p>Beech Pewter Sienna Walnut Natural Cherry Light Oak Slate Hansen Cherry</p> | <p>WC14360 WC14560 WC25560 WC57460 WC64360 WC8460A WC90460A</p> | 88 | 3.3 | Yes | \$451.00 |
|  | <p>48W Desk</p> <ul style="list-style-type: none"> • Accepts Keyboard Trays or Pencil Drawer in the center • Accepts up to two Mobile Pedestals underneath when no Keyboard Tray or Pencil Drawer is present • Accepts 48W Hutch • 47.52"W x 26.81"D x 29.8"H •  (SIN 711-2) | <p>Beech Pewter Sienna Walnut Natural Cherry Light Oak Slate Hansen Cherry</p> | <p>WC14348 WC14548 WC25548 WC57448 WC64348 WC8448A WC90448A</p> | 76 | 3.1 | Yes | \$385.00 |

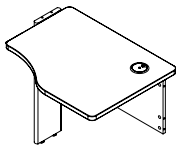
Series A – Work Surfaces (con't)

| | Description | Finish | SKU Number | Shpg Wt. (lbs) | Cube (ft.) | UPS/Fed Ex | List Price |
|---|--|--|---|----------------|------------|------------|------------|
|  | <p>36W Desk</p> <ul style="list-style-type: none"> • Accepts Keyboard Trays or Pencil Drawer in the center • Accepts up to two Mobile Pedestals underneath when no Keyboard Tray or Pencil Drawer is present • Accepts 36W Hutch • 35.59"W x 26.81"D x 29.8"H •  (SIN 711-2) | <p>Beech Pewter Sienna Walnut Natural Cherry Light Oak Slate Hansen Cherry</p> | <p>WC14336 WC14536 WC25536 WC57436 WC64336 WC8436A WC90436A</p> | 62 | 2.7 | Yes | \$355.00 |
|  | <p>72W Universal Freestanding Peninsula</p> <ul style="list-style-type: none"> • Freestanding • Attaches to right or left side of 36W, 48W, 60W, or 72W Desk • Mobile Pedestals cannot fit underneath • 71.18"W x 26.81"D x 29.8"H •  (SIN 711-2) | <p>Beech Pewter Sienna Walnut Natural Cherry Light Oak Slate Hansen Cherry</p> | <p>WC14371 WC14571 WC25571 WC57471 WC64371 WC8435 WC90471A</p> | 93 | 3.9 | Yes | \$415.00 |
|  | <p>27W Corner Connector</p> <ul style="list-style-type: none"> • Connects any two straight desks or any desk and peninsula to form an L-shape • Tested to hold up to 60 lbs. • Not recommended for computer monitors or other heavy equipment • 26.81"W x 26.81"D x 1"H •  (SIN 711-2) | <p>Beech Pewter Sienna Walnut Natural Cherry Light Oak Slate Hansen Cherry</p> | <p>WC14329 WC14529 WC25529 WC57429 WC64329 WC8426 WC90429A</p> | 21 | 1.0 | Yes | \$172.00 |
|  | <p>30W Transitional Bridge</p> <ul style="list-style-type: none"> • Extended Work Surface, for use with Single Pedestal Corner Desk only • Can be used to make an L-Desk configuration, or add a Peninsula, Desk, or Return to make a U-shaped configuration • 29.45"W x 26.81"D x 29.8"H •  (SIN 711-2) | <p>Beech Pewter Sienna Walnut Natural Cherry Light Oak Slate Hansen Cherry</p> | <p>WC14331 WC14531 WC25531 WC57431 WC64331 WC84831 WC94431</p> | 33 | 1.7 | Yes | \$252.00 |











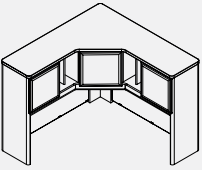

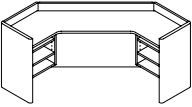
Series A – Hutch Storage

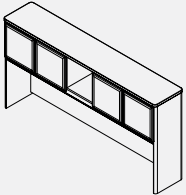
☑ All Hutches include fully finished Back Panel and coordinating fabric covered Tackboard (exception: 42" Corner does not have Tackboard)

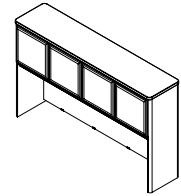
☑ All doors utilize Euro-style hinges

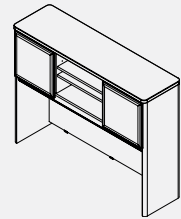
☑ Doors extend below bottom edge of cabinets for ease of opening

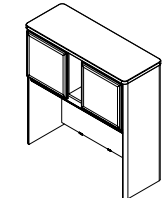
☑ Mounts conveniently to desking, lateral files or storage cabinets







| | Description | Finish | SKU Number | Shpg Wt. (lbs) | Cube (ft.) | UPS/ Fed Ex | List Price |
|---|--|---|---|----------------|------------|-------------|------------|
|  | 48W Corner Hutch <ul style="list-style-type: none"> Mounts on 48W Corner Desk Accepts two Task Lights Includes two Tackboards 47.17"W x 47.17"D x 36.52"H  (SIN 711-2) | Beech Pewter Sienna Walnut Natural Cherry Light Oak Slate Hansen Cherry | WC14367PK WC14567PK WC25567PK WC57467PK WC64367PK WC84867PK WC94467PK | 165 | 6.4 | NO | \$912.00 |
|  | 42W Corner Hutch <ul style="list-style-type: none"> Mounts on 42W Corner Desk Includes two fixed shelves and four adjustable shelves Does not accept Task Light or Tackboard 40.75"W x 40.75"D x 23.56"H  (SIN 711-2) | Beech Pewter Sienna Walnut Natural Cherry Light Oak Slate Hansen Cherry | WC14343 WC14543 WC25543 WC57443 WC64343 WC84843 WC94443 | 81 | 3.3 | Yes | \$492.00 |
|  | 72W Hutch <ul style="list-style-type: none"> Mounts on 72W Desk Accepts two Task Lights 71.54"W x 13.76"D x 36.52"H  (SIN 711-2) | Beech Pewter Sienna Walnut Natural Cherry Light Oak Slate Hansen Cherry | WC14373P WC14573P WC25573P WC57473P WC64373P WC84873P WC94473P | 136 | 5.4 | Yes | \$876.00 |
|  | 60W Hutch <ul style="list-style-type: none"> Mounts on 60W Desk Accepts Task Light 59.57"W x 13.76"D x 36.52"H  (SIN 711-2) | Beech Pewter Sienna Walnut Natural Cherry Light Oak Slate Hansen Cherry | WC14361P WC14561P WC25561P WC57461P WC64361P WC84861P WC94461P | 121 | 4.6 | Yes | \$853.00 |
|  | 48W Hutch <ul style="list-style-type: none"> Mounts on 48W Desk Mounts on one side of 48W Corner Desk Accepts Task Light Includes two Adjustable Shelves 47.52"W x 13.76"D x 36.52"H  (SIN 711-2) | Beech Pewter Sienna Walnut Natural Cherry Light Oak Slate Hansen Cherry | WC14349P WC14549P WC25549P WC57449P WC64349P WC84849P WC94449P | 104 | 3.7 | Yes | \$611.00 |
|  | 36W Hutch <ul style="list-style-type: none"> Mounts on 36W Desk or 36W 2 Drawer Lateral File Accepts Task Light 35.59"W x 13.76"D x 36.52"H  (SIN 711-2) | Beech Pewter Sienna Walnut Natural Cherry Light Oak Slate Hansen Cherry | WC14337P WC14537P WC25537P WC57437P WC64337P WC84837P WC94437P | 83 | 2.9 | Yes | \$482.00 |

Series A – Hutch Storage (con't)

| | Description | Finish | SKU Number | Shpg Wt. (lbs) | Cube (ft.) | UPS/ Fed Ex | List Price |
|---|---|---|--|----------------|------------|-------------|------------|
|  | 24\" Hutch <ul style="list-style-type: none"> Mounts on 24W Piler/Filer Includes one adjustable shelf Does not accept Task Light 23.54\"W x 13.76\"D x 36.52\"H  (SIN 711-2) | Beech Pewter Sienna Walnut Natural Cherry Light Oak Slate Hansen Cherry | WC14325P WC14525P WC25525P WC57425P WC64325P WC84825P WC94425P | 63 | 2.5 | Yes | \$383.00 |

Series A – Filing

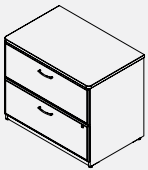
- Exterior case finish matches end panels of desking and hutches
- All box drawers utilize 3/4-extension, ball-bearing slides
- All file drawers utilize full-extension, ball-bearing slides
- All file drawers accommodate letter, legal and A4 paper sizes
- All Mobile Pedestals glide on dual-wheel hooded casters (two locking and two swivel casters)
- Locking
- All drawer locks are keyed alike (contact BBF for information on Lock Cores)







| | Description | Finish | SKU Number | Shpg Wt. (lbs) | Cube (ft.) | UPS/ Fed Ex | List Price |
|---|---|---|--|----------------|------------|-------------|------------|
|  | 2 Drawer Mobile Pedestal (Assembled) <ul style="list-style-type: none"> Rolls under any desking surface (except L-Bow Desks or Freestanding Peninsula) 15.71\"W x 20.16\"D x 27.87\"H  (SIN 711-3) | Beech Pewter Sienna Walnut Natural Cherry Light Oak Slate Hansen Cherry | WC14352PSU WC14552PSU WC25552PSU WC57452PSU WC64352PSU WC84852PSU WC94452PSU | 63 | 7 | Yes | \$476.00 |
|  | 3 Drawer Mobile Pedestal (Assembled) <ul style="list-style-type: none"> Rolls under any desking surface (except L-Bow Desks) 15.71\"W x 20.16\"D x 27.87\"H  (SIN 711-3) | Beech Pewter Sienna Walnut Natural Cherry Light Oak Slate Hansen Cherry | WC14353PSU WC14553PSU WC25553PSU WC57453PSU WC64353PSU WC84853PSU WC94453PSU | 66 | 6.8 | Yes | \$486.00 |
|  | 36W 2 Drawer Lateral File (Assembled) <ul style="list-style-type: none"> Accepts 36W Hutch Lateral File top shelf matches Desk Work Surface height 35.67\"W x 23.35\"D x 29.8\"H  (SIN 711-3) | Beech Pewter Sienna Walnut Natural Cherry Light Oak Slate Hansen Cherry | WC14354PSU WC14554PSU WC25554PSU WC57454PSU WC64354PSU WC84854PSU WC94454PSU | 146 | 19.0 | NO | \$761.00 |

Series A – Storage

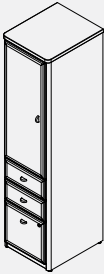
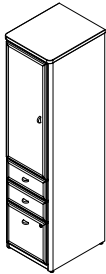
☑ All doors utilize Euro-style hinges

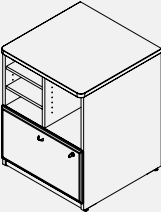
☑ All file drawers utilize full-extension, ball-bearing slides

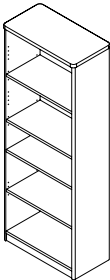



☑ All box drawers utilize 3/4-extension, ball-bearing slides

| | Description | Finish | SKU Number | Shpg Wt. (lbs) | Cube (ft.) | UPS/ Fed Ex | List Price |
|---|---|--|---|----------------|------------|-------------|------------|
|  | <p>Vertical Locker</p> <ul style="list-style-type: none"> • One file drawer accommodates letter-size hanging files • Two box drawers for small office supplies • Two adjustable shelves (22 position options) and coat hook in upper storage area • Non-handed door mounts on right or left side • 16.1"W x 20.26"D x 66.3"H • Not on GSA Contract | <p>Beech Pewter Sienna Walnut Natural Cherry Light Oak Slate Hansen Cherry</p> | <p>WC14375P WC14575P WC25575P WC57475P WC64375P WC84875P WC94475P</p> | 109 | 3.8 | Yes | \$642.00 |
|  | <p>Vertical Locker (Assembled)</p> <ul style="list-style-type: none"> • One file drawer accommodates letter-size hanging files • Two box drawers for small office supplies • Two adjustable shelves (22 position options) and coat hook in upper storage area • Non-handed door mounts on right or left side • 16.1"W x 20.26"D x 66.3"H •  (SIN 711-3) | <p>Beech Pewter Sienna Walnut Natural Cherry Light Oak Slate Hansen Cherry</p> | <p>WC14375PSU WC14575PSU WC25575PSU WC57475PSU WC64375PSU WC84875PSU WC94475PSU</p> | 132 | 18.3 | Yes | \$907.00 |
|  | <p>24W Piler/Filer</p> <ul style="list-style-type: none"> • Lateral file drawer holds letter, legal, or A4 files • Durable edge banding stands up to bumps and collisions • Accepts 24W Hutch • Two adjustable shelves (11 position options) and round grommet in back panel for wire access • 23.54"W x 23.35"D x 29.8"H •  (SIN 711-3) | <p>Beech Pewter Sienna Walnut Natural Cherry Light Oak Slate Hansen Cherry</p> | <p>WC14323P WC14523P WC25523P WC57423P WC64323P WC84823P WC94423P</p> | 94 | 3.7 | Yes | \$503.00 |
|  | <p>26W 5 Shelf Bookcase</p> <ul style="list-style-type: none"> • Height and depth match Hutch • Lower storage has one adjustable shelf with 4 position options • Upper storage area has two adjustable shelves with 14 total position options • Top shelf finished with edge banding to match Hutch top shelf • 25.35"W x 13.5"D x 66.18"H •  (SIN 711-2) | <p>Beech Pewter Sienna Walnut Natural Cherry Light Oak Slate Hansen Cherry</p> | <p>WC14365 WC14565 WC25565 WC57465 WC64365 WC84865 WC94465</p> | 96 | 3.7 | Yes | \$318.00 |

Series A – Conference Tables

- ☑ Work Surfaces are constructed of 100% thermally fused laminate with durable edge band to resist scratches and stains
- ☑ All Work Surfaces and Leg End Panels are 1" thick

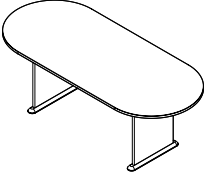
- ☑ All bases/feet are Graphite Gray
- ☑ Each foot has levelers to adjust for uneven floor surfaces

| | Description | Finish | SKU Number | Shpg Wt. (lbs) | Cube (ft.) | UPS/ Fed Ex | List Price |
|---|---|---|---|----------------|------------|-------------|------------|
|  | <p>42W Round Conference Table</p> <ul style="list-style-type: none"> • Comfortable seating for four people • Stable X panel base • 41.38"W x 41.38"D x 29.8"H •  (SIN 711-11) | Beech Pewter Sienna Walnut Natural Cherry Light Oak Slate Hansen Cherry | TB14342A TB14542A TB25542 TB57442 TB64342A TB84242A TB90442A | 76 | 3.1 | Yes | \$401.00 |
|  | <p>82W x 35D Racetrack Conference Table</p> <ul style="list-style-type: none"> • Comfortable seating for six people • Stable panel base • 81.54"W x 34.49"D x 29.76"H •  (SIN 711-11) | Beech Pewter Sienna Walnut Natural Cherry Light Oak Slate Hansen Cherry | TR14384A TR14584A TR25584 TR57484A TR64384A TR84284A TR90484A | 120 | 5.1 | Yes | \$679.00 |

Easy Office™



10-Year
Manufacturer's
Warranty

Easy Office™ – Work Stations

- ☑ Quick and easy assembly with pre-installed connectors, minimal parts and a simple sturdy design
- ☑ Workstations available in Straight or L-desk formats
- ☑ Choose from 7 convenient pre-packaged configuration options
- ☑ L-Desks configured for Right or Left handed use
- ☑ Thermally fused laminate on worksurface
- ☑ Adjustable levelers for uneven floors
- ☑ Low Height Panels for team collaboration
- ☑ Allows for expansion as your needs change
- ☑ Meets ANSI BIFMA standards for safety and performance
- ☑ Commercial quality backed by 10 year warranty
- ☑ 1" thick fabric covered panels
- ☑ 1" thick work surfaces
- ☑ Wire management grommets

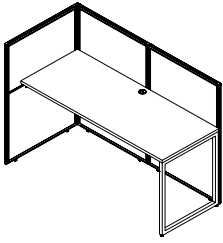
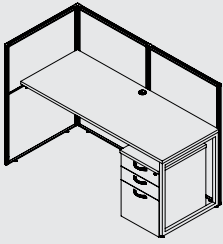
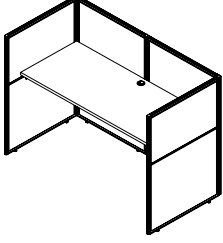
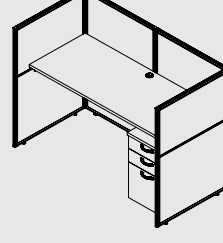
| | Description | Finish | SKU Number | Box Qty. | Shpg Wt. (lbs) | Cube (ft.) | UPS/ Fed Ex | List Price |
|---|--|--------------|---------------|------------------|--|--|-------------|------------|
|  | 60W Straight Desk Open Office <ul style="list-style-type: none"> • Includes Panels • 60.04"W x 30.51"D x 44.88"H • Not on GSA Contract | Mocha Cherry | EOD160MR-03K | 1 1 1 | Box 1 27 Box 2 51 Box 3 56 | Box 1 2.6 Box 2 4.5 Box 3 4.7 | Yes | \$925.00 |
|  | 60W Straight Desk Open Office with 3 Drawer Mobile Pedestal <ul style="list-style-type: none"> • Includes Panels • Includes (1) 3 Drawer Pedestal • 60.04"W x 30.51"D x 44.88"H • Not on GSA Contract | Mocha Cherry | EOD160SMR-03K | 1 1 1 1 | Box 1 27 Box 2 51 Box 3 56 Box 4 80 | Box 1 2.6 Box 2 4.5 Box 3 4.7 Box 4 7.6 | Yes | \$1,385.00 |
|  | 60W Straight Desk Closed Office <ul style="list-style-type: none"> • Includes Panels • 61.02"W x 30.51"D x 44.88"H • Not on GSA Contract | Mocha Cherry | EOD260MR-03K | 2 1 | Box 1 51 Box 2 56 | Box 1 4.5 Box 2 4.7 | Yes | \$1,123.00 |
|  | 60W Straight Desk Closed Office with 3 Drawer Mobile Pedestal <ul style="list-style-type: none"> • Includes Panels • Includes (1) 3 Drawer Pedestal • 61.02"W x 30.51"D x 44.88"H • Not on GSA Contract | Mocha Cherry | EOD260SMR-03K | 2 1 1 | Box 1 51 Box 2 56 Box 3 80 | Box 1 4.5 Box 2 4.7 Box 3 7.6 | Yes | \$1,583.00 |

Easy Office – Workstations (con't)

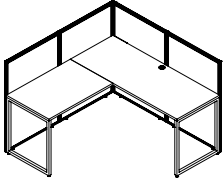
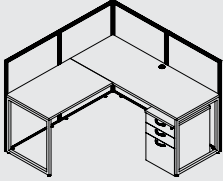
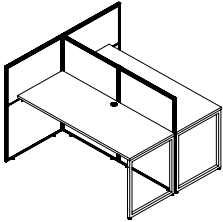
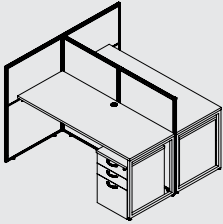
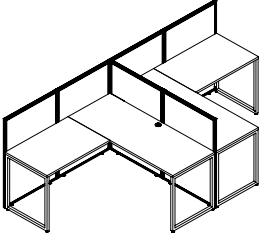
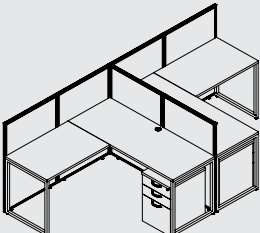
| | Description | Finish | SKU Number | Box Qty. | Shpg Wt. (lbs) | Cube (ft.) | UPS/ Fed Ex | List Price |
|---|---|--------------|---------------|------------------|--|--|-------------|------------|
|  | 60W L Desk Open Office <ul style="list-style-type: none"> Includes Panels 60.04"W x 60.04"D x 44.88"H Not on GSA Contract | Mocha Cherry | EOD360MR-03K | 1 2 1 | Box 1 36 Box 2 51 Box 3 56 | Box 1 2.6 Box 2 4.5 Box 3 4.7 | Yes | \$1,300.00 |
|  | 60W L Desk Open Office with 3 Drawer Mobile Pedestal <ul style="list-style-type: none"> Includes Panels Includes (1) 3 Drawer Pedestal 60.04"W x 60.04"D x 44.88"H Not on GSA Contract | Mocha Cherry | EOD360SMR-03K | 1 2 1 1 | Box 1 36 Box 2 51 Box 3 56 Box 4 80 | Box 1 2.6 Box 2 4.5 Box 3 4.7 Box 4 7.6 | Yes | \$1,760.00 |
|  | 60W 2 Person Straight Desk Open Office <ul style="list-style-type: none"> Includes Panels 60.04"W x 60.04"D x 44.88"H Not on GSA Contract | Mocha Cherry | EOD460MR-03K | 2 2 | Box 1 51 Box 2 56 | Box 1 4.5 Box 2 4.7 | Yes | \$1,454.00 |
|  | 60W 2 Person Straight Desk Open Office with 3 Drawer Mobile Pedestals <ul style="list-style-type: none"> Includes Panels Includes (2) 3 Drawer Pedestals 60.04"W x 60.04"D x 44.88"H Not on GSA Contract | Mocha Cherry | EOD460SMR-03K | 2 2 2 | Box 1 51 Box 2 56 Box 3 80 | Box 1 4.5 Box 2 4.7 Box 3 7.6 | Yes | \$2,374.00 |
|  | 60W 2 Person L Desk Open Office <ul style="list-style-type: none"> Includes Panels 60.04"W x 119.09"D x 44.88"H Not on GSA Contract | Mocha Cherry | EOD560MR-03K | 2 3 2 | Box 1 36 Box 2 51 Box 3 56 | Box 1 2.6 Box 2 4.5 Box 3 4.7 | Yes | \$2,204.00 |
|  | 60W 2 Person L Desk Open Office with 3 Drawer Mobile Pedestals <ul style="list-style-type: none"> Includes Panels Includes (2) 3 Drawer Pedestals 60.04"W x 119.09"D x 44.88"H Not on GSA Contract | Mocha Cherry | EOD560SMR-03K | 2 3 2 2 | Box 1 36 Box 2 51 Box 3 56 Box 4 80 | Box 1 2.6 Box 2 4.5 Box 3 4.7 Box 4 7.6 | Yes | \$3,124.00 |

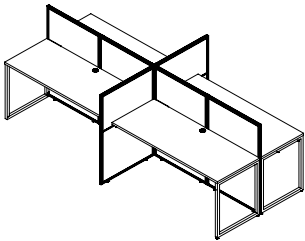
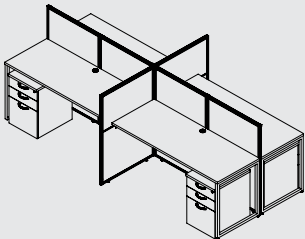
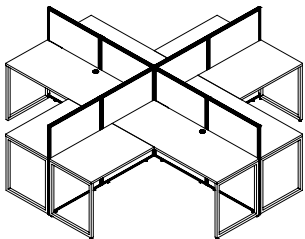
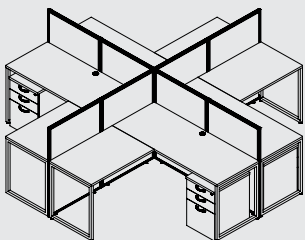
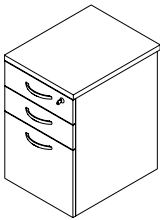
| | Description | Finish | SKU Number | Box Qty. | Shpg Wt. (lbs) | Cube (ft.) | UPS/ Fed Ex | List Price |
|---|---|--------------|---------------|------------------|--|--|-------------|------------|
|  | <p>60W 4 Person Straight Desk Open Office</p> <ul style="list-style-type: none"> Includes Panels 119.09"W x 60.04"D x 44.88"H Not on GSA Contract | Mocha Cherry | EOD660MR-03K | 3 4 | Box 1 51 Box 2 56 | Box 1 4.5 Box 2 4.7 | Yes | \$2,512.00 |
|  | <p>60W 4 Person Straight Desk Open Office with 3 Drawer Mobile Pedestals</p> <ul style="list-style-type: none"> Includes Panels Includes (4) 3 Drawer Pedestals 119.09"W x 60.04"D x 44.88"H Not on GSA Contract | Mocha Cherry | EOD660SMR-03K | 3 4 4 | Box 1 51 Box 2 56 Box 3 80 | Box 1 4.5 Box 2 4.7 Box 3 7.6 | Yes | \$4,352.00 |
|  | <p>60W 4 Person L Desk Open Office</p> <ul style="list-style-type: none"> Includes Panels 110.09"W x 119.09"D x 44.88"H Not on GSA Contract | Mocha Cherry | EOD760MR-03K | 4 4 4 | Box 1 27 Box 2 51 Box 3 56 | Box 1 2.6 Box 2 4.5 Box 3 4.7 | Yes | \$3,616.00 |
|  | <p>60W 4 Person L Desk Open Office with 3 Drawer Mobile Pedestals</p> <ul style="list-style-type: none"> Includes Panels Includes (4) 3 Drawer Pedestals 110.09"W x 119.09"D x 44.88"H Not on GSA Contract | Mocha Cherry | EOD760SMR-03K | 4 4 4 4 | Box 1 36 Box 2 51 Box 3 56 Box 4 80 | Box 1 2.6 Box 2 4.5 Box 3 4.7 Box 4 7.6 | Yes | \$5,456.00 |
|  | <p>16W 3 Drawer Pedestal</p> <ul style="list-style-type: none"> Durable laminate finish provides resistance to scratches and stains Ships fully assembled Lockable file holds letter and legal size files Full extension ball bearing slides on all drawers Casters for easy mobility Two box drawers offer storage area for supplies Fits under the desk surface to maximize space 15.98"W x 20.08"D x 25.37"H Not on GSA Contract | Mocha Cherry | EOF116MR-03 | 1 | 80 | 7.6 | Yes | \$460.00 |

Office in an Hour



10-Year
Manufacturer's
Warranty

Office in an Hour – Work Stations

Workstations

- Durable, thermally fused laminate work surfaces features superior resistance to scratches and stains
- Desk top grommets included for wire management
- Removable side panel on metal legs for wire management
- Each foot has two adjustable levelers to accommodate uneven floors
- All drawers utilize full-extension, ball-bearing slides

Panels

- Metal framed cushioned panels covered by two-tone fabric
- Both short and tall panels included in each package
- Post connectors and feet include adjustable levelers to accommodate uneven floors
- Slotted to accept Storage/Accessory Kit
- Configuration is fixed, cannot be switched to other hand

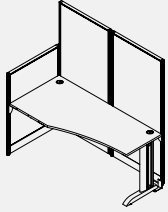
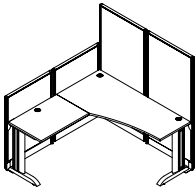
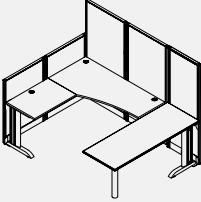
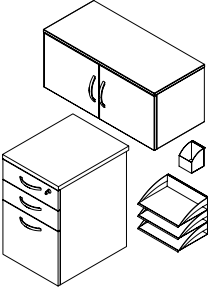
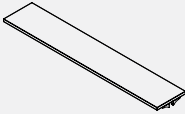
| | Description | Finish | SKU Number | Shpg Wt. (lbs) | Cube (ft.) | UPS/ Fed Ex | List Price |
|---|---|-------------------------------|----------------------------|---|---|-------------|------------|
|  | 65W x 33D Straight Workstation <ul style="list-style-type: none"> • Includes Panels • Accepts Articulating Keyboard or Deluxe Articulating Keyboard Tray • Ships in two boxes • 64.49"W x 32.24"D x 62.99"H • Not on GSA Contract | Hansen Cherry Mocha Cherry | WC36492-03K WC36892-03K | Box 1 112 Box 2 73 | Box 1 10.4 Box 2 8.6 | Yes | \$1,261.00 |
|  | 65W x 65D L-Workstation <ul style="list-style-type: none"> • Includes Panels • Accepts Reception Gallery Shelf accessory • Accepts Articulating Keyboard Trays on Return surface • Ships in two boxes • 64.49"W x 64.49"D x 62.99"H • Not on GSA Contract | Hansen Cherry Mocha Cherry | WC36494-03K WC36894-03K | Box 1 141 Box 2 105 | Box 1 12.5 Box 2 10.6 | Yes | \$1,767.00 |
|  | 89W x 65D U-Workstation <ul style="list-style-type: none"> • Includes Panels • Accepts Reception Gallery Shelf accessory • Accepts Articulating Keyboard Trays on Return surface • Ships in three boxes • 88.23"W x 64.49"D x 62.99"H • Not on GSA Contract | Hansen Cherry Mocha Cherry | WC36496-03K WC36896-03K | Box 1 141 Box 2 105 Box 3 82 | Box 1 2.5 Box 2 10.6 Box 3 6.5 | Yes | \$2,656.00 |
|  | Storage/Accessory Kit <ul style="list-style-type: none"> • Includes one Storage Cabinet, Mobile Pedestal, Adjustable Paper Tray and Pencil Cup • Mounts to slots in tall wall panels of all Workstations • Ships in one box • Mobile Pedestal and Cabinet are fully assembled • Mobile Pedestal has casters for easy mobility • Storage Cabinet – 31.49"W x 13.62"D x 13.5"H • Mobile Pedestal – 15.98"W x 20.07"D x 25.39"H • Not on GSA Contract | Hansen Cherry Mocha Cherry | WC36490-03 WC36890-03 | 119 | 13.8 | Yes | \$757.00 |
|  | 64W x 12D Reception Gallery Shelf <ul style="list-style-type: none"> • Used to provide convenient reception shelf space • Durable, thermally-fused laminate Work Surfaces resist scratches and stains • Mounts to top of short panels of the L- or U-Workstations • 63.78"W x 11.46"D x 0.98"H • Not on GSA Contract | Hansen Cherry Mocha Cherry | WC36491-03 WC36891-03 | 23 | 1.3 | Yes | \$239.00 |

Venture

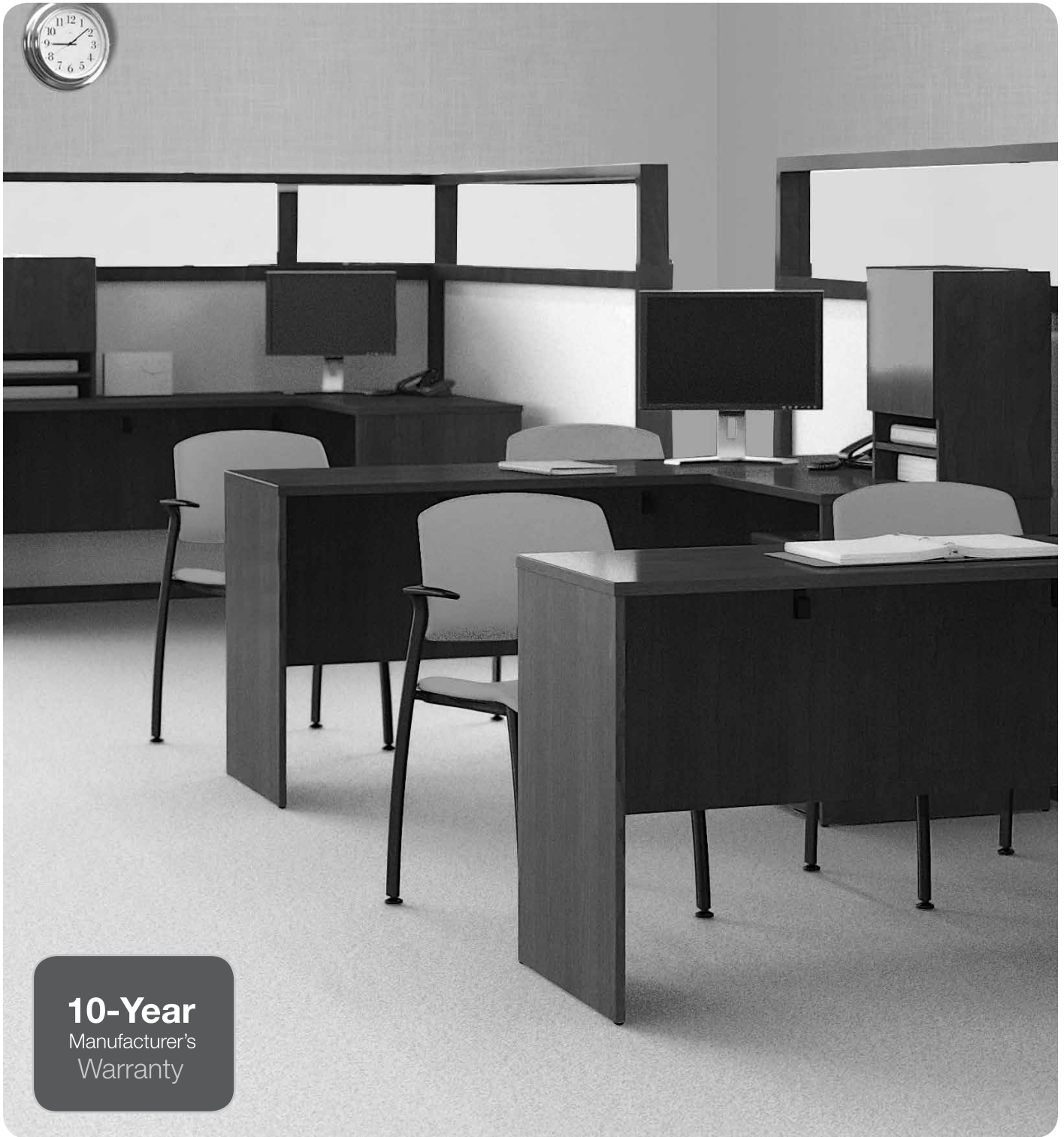

10-Year
Manufacturer's
Warranty

bbf
BUSH BUSINESS FURNITURE

Venture Workstation

- Constructed with 100% thermally fused laminate for durability and superior resistance to scratches and stains
- Pre-drilled to accept Keyboard Trays or Storage Drawers
- Includes one 4-port USB hub
- Pedestal ships fully assembled
- All drawers utilize full-extension, ball-bearing suspensions
- Return can be attached to form a left or right configuration
- Micro Hutch can be mounted in three locations
- Door utilizes Euro-style hinge
- Ships in two boxes

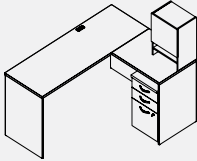
| | Description | Finish | SKU Number | Shpg Wt. (lbs) | Cube (ft.) | UPS/Fed Ex | List Price |
|---|--|---------------|------------|----------------|------------|------------|------------|
|  | <p>66W x 52D L-Workstation</p> <ul style="list-style-type: none"> • Includes: <ul style="list-style-type: none"> one Mobile Pedestal one Micro Hutch one L/R Return • 66"W x 52.72"D x 50.12"H • Not on GSA Contract | Hansen Cherry | 3699CL-03K | Box 1 | Box 1 | Yes | \$1,053.00 |
| | | | | 88 | 8.2 | | |
| | | | | Box 2 | Box 2 | | |
| | | | | 135 | 6.4 | | |



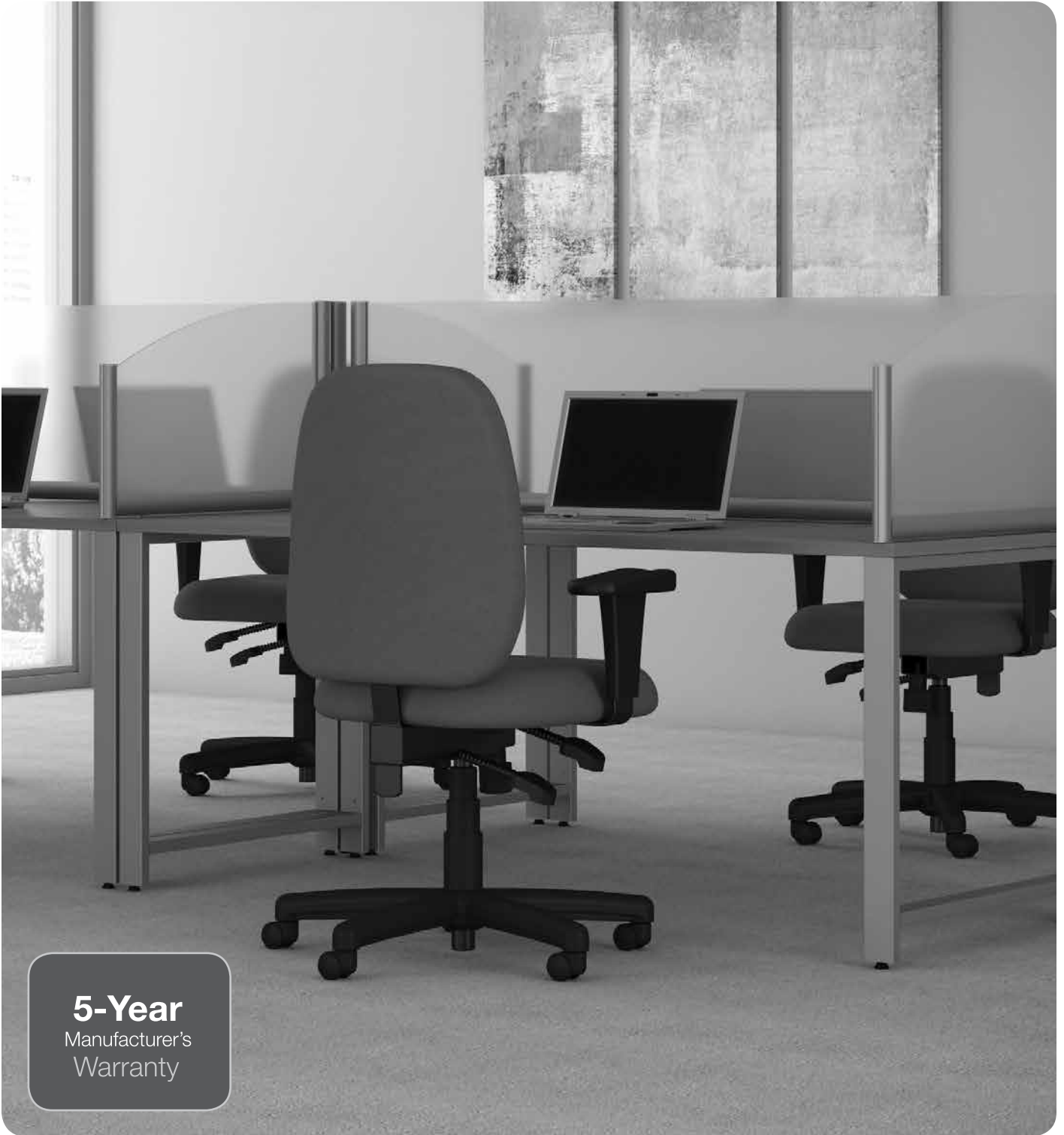











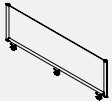

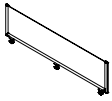

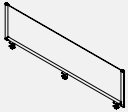







Privacy Screens



5-Year
Manufacturer's
Warranty

Privacy Screens

☑ Screens are sized to fit Desk size with a side screen on each side. If installed without side screens, the primary screen will be approximately 2 to 2-1/2" shorter than the Desk depending on product family.

| | Description | Finish | SKU Number | Shpg Wt. (lbs) | Cube (ft.) | UPS/Fed Ex | List Price |
|---|--|--|------------|---------------------------|-----------------------------|------------|------------|
|  | 42W Desktop Privacy Screen <ul style="list-style-type: none"> Mounts to 42W Returns – Series C Elite, Realize, Sector, Momentum Dogleg 39.49"W x 17.72"H •  (SIN 711-2) | Frosted Acrylic with Anodized Aluminum | PSP142FR | 12 | 1.6 | Yes | \$430.00 |
|  | 48W Desktop Privacy Screen <ul style="list-style-type: none"> Mounts to 48W Desks and Returns – Series C Elite, Realize, Sector, Series A & Series C Corner Desks 45.67"W x 17.72"H •  (SIN 711-2) | Frosted Acrylic with Anodized Aluminum | PSP148FR | 14 | 1.8 | Yes | \$462.00 |
|  | 60W Desktop Privacy Screen <ul style="list-style-type: none"> Mounts to 60W Desks on Series A, Series C, Series C Elite, Realize, Sector, Momentum 60" and long side of Dogleg 57.52"W x 17.72"H •  (SIN 711-2) | Frosted Acrylic with Anodized Aluminum | PSP160FR | 18 | 2.2 | Yes | \$626.00 |
|  | 66W Desktop Privacy Screen <ul style="list-style-type: none"> Mounts to 66W Desks on Series C, Series C Elite, Realize, 64.96"W x 17.72"H •  (SIN 711-2) | Frosted Acrylic with Anodized Aluminum | PSP166FR | 19 | 2.4 | Yes | \$639.00 |
|  | 72W Desktop Privacy Screen <ul style="list-style-type: none"> Mounts to 72W Desks in Momentum, Series A, Series C, Series C Elite, Sector, Realize 69.09"W x 17.72"H •  (SIN 711-2) | Frosted Acrylic with Anodized Aluminum | PSP172FR | 21 | 2.6 | Yes | \$650.00 |
|  | Top Mount Hardware (Set of 3) <ul style="list-style-type: none"> Top Mount used when flush side or back panel is present. Fastens with screws to work surface. (3/pk) •  (SIN 711-2) | Frosted Acrylic with Anodized Aluminum | PSP202SV | .5 | 0.1 | Yes | \$45.00 |
|  | 24W Side Desktop Privacy Screen <ul style="list-style-type: none"> Used on 22 and 24D Work Surfaces. Package with hinge and non-skid pad 21.42"W x 17.72"H •  (SIN 711-2) | Frosted Acrylic with Anodized Aluminum | PSP124FR | 7 | .8 | Yes | \$363.00 |
|  | 30W Side Desktop Privacy Screen <ul style="list-style-type: none"> Used on 30" deep work surfaces. Package with hinge and non-skid pad 28.82"W x 17.72"H •  (SIN 711-2) | Frosted Acrylic with Anodized Aluminum | PSP130FR | 9 | 1.1 | Yes | \$393.00 |
|  | Freestanding White Board Screen with Stationary Base <ul style="list-style-type: none"> 35.24"W x 62.4"H •  (SIN 711-2) | White with Anodized Aluminum | PSP335WHK | Box 1 25 Box 2 8 | Box 1 4.1 Box 2 .4 | Yes | \$786.00 |
|  | Freestanding White Board Screen with Wheeled Base <ul style="list-style-type: none"> 35.24"W x 62.4"H •  (SIN 711-2) | White with Anodized Aluminum | PSP435WHK | Box 1 25 Box 2 5 | Box 1 4.1 Box 2 .3 | Yes | \$836.00 |
|  | Freestanding Frosted Acrylic Screen with Stationary Base <ul style="list-style-type: none"> 35.24"W x 62.4"H •  (SIN 711-2) | Frosted Acrylic with Anodized Aluminum | PSP535FRK | Box 1 27 Box 2 8 | Box 1 4.1 Box 2 .4 | Yes | \$799.00 |
|  | Freestanding Frosted Acrylic Screen with Wheeled Base <ul style="list-style-type: none"> 35.24"W x 62.4"H •  (SIN 711-2) | Frosted Acrylic with Anodized Aluminum | PSP635FRK | Box 1 27 Box 2 5 | Box 1 4.1 Box 2 .3 | Yes | \$849.00 |
|  | Accessory Board Clips for Freestanding Screens <ul style="list-style-type: none"> Easily attaches to hang flip charts •  (SIN 711-2) | Silver | PSP102CL | .4 | 0.1 | Yes | \$37.00 |

ProPanels



10-Year
Manufacturer's
Warranty

ProPanels

Panels

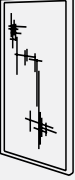
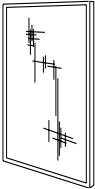
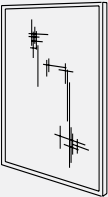

- Durable extruded frames trimmed with fabric-covered Panels
- Panel interiors have a rigid engineered wood frame with a combination of hardboard/corrugated interiors
- All Panels include straight-line connection hardware to mount to similar height panel
- Panels include adjustable levelers
- 3/4" space under Panel to floor with levelers fully inserted
- Meets ANSI/BIFMA standards for safety and performance
- Non-tackable
- Not powered

| | Description | Finish | SKU Number | Shpg Wt. (lbs) | Cube (ft.) | UPS/Fed Ex | List Price |
|---|--|---------------------------------------|--------------------------|----------------|------------|------------|------------|
|  | <p>42H x 36W Panel</p> <ul style="list-style-type: none"> • A post is required when connecting panels in L, T, or X-shapes. A post is not required for a straight-line connection. Posts are included in applicable connector kits. • 36.04"W x 1.77"D x 42.76"H • Not on GSA Contract | Harvest Tan/Taupe Light Gray/Slate | PP42536-03 PP42736-03 | 26 | 2.5 | Yes | \$367.00 |
|  | <p>42H x 48W Panel</p> <ul style="list-style-type: none"> • A post is required when connecting panels in L, T, or X-shapes. A post is not required for a straight-line connection. Posts are included in applicable connector kits. • 48.03"W x 1.77"D x 42.76"H • Not on GSA Contract | Harvest Tan/Taupe Light Gray/Slate | PP42548-03 PP42748-03 | 37 | 3.3 | Yes | \$428.00 |
|  | <p>42H x 60W Panel</p> <ul style="list-style-type: none"> • A post is required when connecting panels in L, T, or X-shapes. A post is not required for a straight-line connection. Posts are included in applicable connector kits. • 60.03"W x 1.77"D x 42.76"H • Not on GSA Contract | Harvest Tan/Taupe Light Gray/Slate | PP42560-03 PP42760-03 | 40 | 4.0 | Yes | \$516.00 |

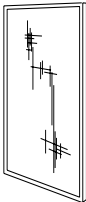
Propanels (con't)

| | Description | Finish | SKU Number | Shpg Wt. (lbs) | Cube (ft.) | UPS/ Fed Ex | List Price |
|---|--|---------------------------------------|--------------------------|----------------|------------|-------------|------------|
|  | <p>66H x 36W Panel</p> <ul style="list-style-type: none"> • A post is required when connecting panels in L, T, or X-shapes. A post is not required for a straight-line connection. Posts are included in applicable connector kits. • 36.04"W x 1.77"D x 66.79"H • Not on GSA Contract | Harvest Tan/Taupe Light Gray/Slate | PP66536-03 PP66736-03 | 41 | 3.9 | Yes | \$428.00 |
|  | <p>66H x 48W Panel</p> <ul style="list-style-type: none"> • A post is required when connecting panels in L, T, or X-shapes. A post is not required for a straight-line connection. Posts are included in applicable connector kits. • 48.01"W x 1.77"D x 66.79"H • Not on GSA Contract | Harvest Tan/Taupe Light Gray/Slate | PP66548-03 PP66748-03 | 53 | 5.0 | NO | \$486.00 |
|  | <p>66H x 60W Panel</p> <ul style="list-style-type: none"> • A post is required when connecting panels in L, T, or X-shapes. A post is not required for a straight-line connection. Posts are included in applicable connector kits. • 60.02"W x 1.77"D x 66.79"H • Not on GSA Contract | Harvest Tan/Taupe Light Gray/Slate | PP66560-03 PP66760-03 | 77 | 6.2 | NO | \$610.00 |
|  | <p>Wall Starter Kit</p> <ul style="list-style-type: none"> • Connects one Panel to a permanent wall structure (necessary wall mounting hardware not included and must be provided by customer) • Not on GSA Contract | Taupe Slate | PH99501-03 PP84901-03 | 3 | 0.1 | Yes | \$49.00 |

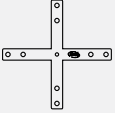
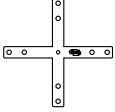
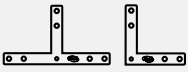
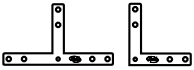
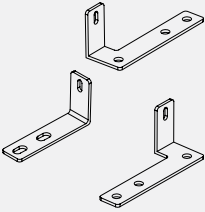
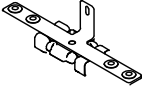
ProPanels (con't)



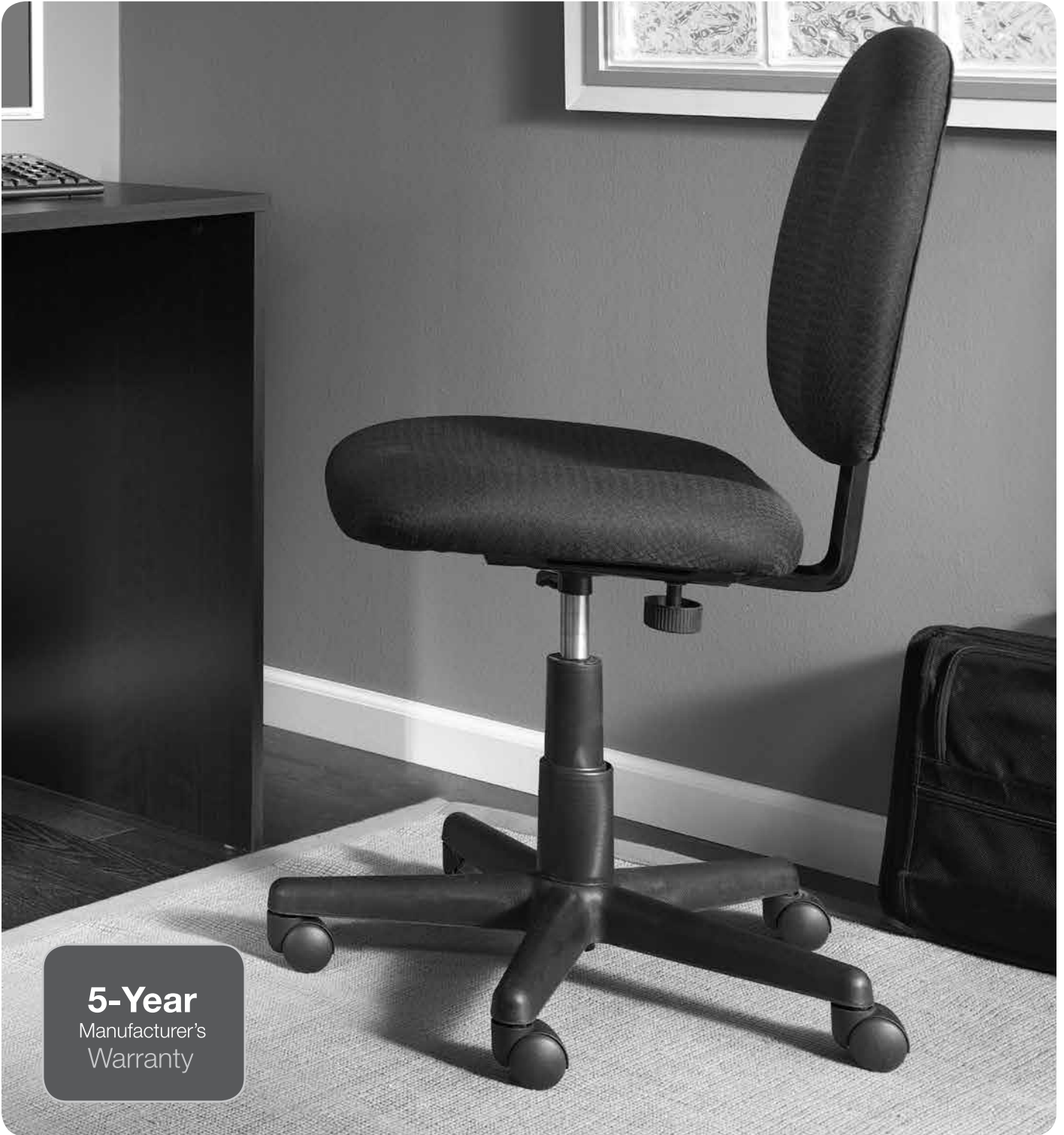

| | Description | Finish | SKU Number | Shpg Wt. (lbs) | Cube (ft.) | UPS/ Fed Ex | List Price |
|---|--|----------------|--------------------------|----------------|------------|-------------|------------|
|  | <p>X Connector with 42H Post</p> <ul style="list-style-type: none"> Used to connect four 42H Panels in an X-configuration Includes X-Connector with 42H Connector Post (not shown) Not on GSA Contract | Taupe Slate | PH99543-03 PP99743-03 | 3 | 0.5 | Yes | \$95.00 |
|  | <p>X Connector with 66H Post</p> <ul style="list-style-type: none"> Used to connect four 66H Panels in an X-configuration Includes X-Connector with 66H Connector Post (not shown) Not on GSA Contract | Taupe Slate | PH99568-03 PP84714-03 | 6 | 0.8 | Yes | \$95.00 |
|  | <p>2 Way or 3 Way Connector with 66H Post</p> <ul style="list-style-type: none"> Used to connect two 66H Panels in an L-configuration or three Panels in a T-configuration Includes 2-Way Connector, 3-Way Connector and 66H Connector Post (not shown) Not on GSA Contract | Taupe Slate | PH99566-03 PH99766-03 | 6 | 1.0 | Yes | \$95.00 |
|  | <p>2 Way or 3 Way Connector with 42H Post</p> <ul style="list-style-type: none"> Used to connect two 42H Panels in an L-configuration or three panels in a T-configuration Includes 2-Way Connector, 3-Way Connector and 42H Connector Post (not shown) Not on GSA Contract | Taupe Slate | PH99542-03 PH99742-03 | 5 | 0.5 | Yes | \$95.00 |
|  | <p>High/Low Connectors with 42H Post</p> <ul style="list-style-type: none"> Used to connect one 42H and one 66H Panel in a straight-line configuration Can be used to connect one 42H and one 66H Panel in an L-configuration (customer must drill one hole to complete installation) Contains: Left, Right & Straight Connectors plus 42H Post (not shown) Not on GSA Contract | Taupe Slate | PH99590-03 PH99790-03 | 4 | 0.4 | Yes | \$108.00 |
|  | <p>High/Low 3 Way Connector</p> <ul style="list-style-type: none"> Used to connect 66H straight line configuration to a 42H straight line configuration Not on GSA Contract | Taupe Slate | PH99593-03 PH99793-03 | 5 | 0.5 | Yes | \$95.00 |
|  | <p>Foot Kit</p> <ul style="list-style-type: none"> Allows one panel to stand independently Includes two feet: one for each end Raises the Panel 1½" off the floor Feet extend 8.39" on each side of Panel Kit recommended if Panel length exceeds 8' Not on GSA Contract | Taupe Slate | PH99599-03 PP84999-03 | 4 | 0.1 | Yes | \$63.00 |

Seating

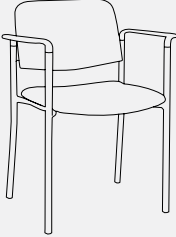
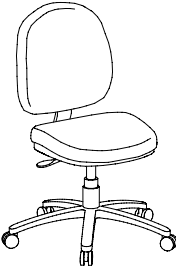
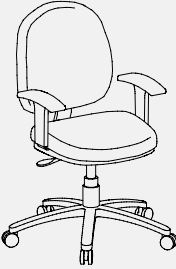
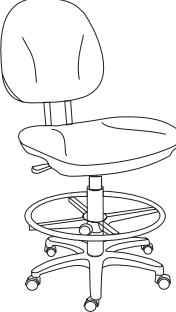

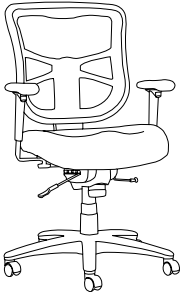
5-Year
Manufacturer's
Warranty

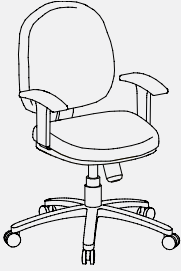
| | Description | Finish | SKU Number | Shpg Wt. (lbs) | Cube (ft.) | UPS/ Fed Ex | List Price |
|---|---|-------------------|------------|---------------------------|------------------------------|-------------|------------|
|  | <p>Guest Chair</p> <ul style="list-style-type: none"> • Cushioned seat and back • Black steel base • Black faux leather seat and back • Stacks up to 4 chairs high • Meets ANSI/BIFMA standards for safety and performance • Commercial quality backed by 5-Year Warranty • 17.75"W x 18.88"D x 32.13"H • Not on GSA Contract | Black Fabric | CH57506K | 22 | 2.4 | Yes | \$203.00 |
|  | <p>Task Chair</p> <ul style="list-style-type: none"> • 5 Point caster base • Ergonomic design • Pneumatic seat height adjustment • Seat glide mechanism • 360-degree swivel • Cushioned black fabric seat and back • Meets ANSI/BIFMA standards for safety and performance • Commercial quality backed by 5-Year Warranty • 18.27"W x 19.25"D x 41.1"H • Not on GSA Contract | Black Fabric | CH57501K | 27 | 3.5 | Yes | \$227.00 |
|  | <p>Task Chair with Arms</p> <ul style="list-style-type: none"> • 5 Point caster base • Ergonomic design • Pneumatic seat height adjustment • Seat glide mechanism • 360-degree swivel • Cushioned black fabric seat and back • Height adjustable arms • Meets ANSI/BIFMA standards for safety and performance • Commercial quality backed by 5-Year Warranty • 18.27"W x 19.25"D x 41.1"H • Not on GSA Contract | Black Fabric | CH57502K | Box 1 8 Box 2 27 | Box 1 0.7 Box 2 3.5 | Yes | \$360.00 |
|  | <p>Task Stool</p> <ul style="list-style-type: none"> • Stool swivels for your convenience • Adjust Stool height and foot ring location for maximum comfort • Pneumatic seat height adjustment for easy adaptability • Cushioned black fabric seat and back • Waterfall seat edge helps relieve pressure points on the underside of legs • 5 Point caster base • Stool supports up to 250 pounds • 19.50"W x 26.75"D x 40.75"H • Not on GSA Contract | Black Leatherette | CH57513K | 35 | 5.2 | Yes | \$319.00 |

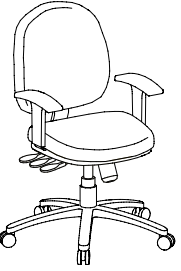
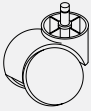
| | Description | Finish | SKU Number | Shpg Wt. (lbs) | Cube (ft.) | UPS/Fed Ex | List Price |
|---|--|--------------|----------------|----------------|------------|------------|------------|
|  | <p>Leather Managers Chair</p> <ul style="list-style-type: none"> • 5 Point caster base • Ergonomic design • Pneumatic seat height adjustment • Tilt function with lock and tension adjustment • 360-degree swivel • Vinyl arm rests • Cushioned black leather seat and back • Meets ANSI/BIFMA standards for safety and performance • Commercial quality backed by 5-Year Warranty • 25.24"W x 21.26"D x 43.74"H • Not on GSA Contract | Black Fabric | CH57505K | 38 | 7.2 | Yes | \$340.00 |
|  | <p>Mesh Back Managers Chair</p> <ul style="list-style-type: none"> • 5 Point caster base • Ergonomic design • Pneumatic seat height adjustment • Height adjustable arm rests • Height adjustable back with tilt and tension lock • 360-degree swivel • Cushioned black fabric seat with mesh back • Meets ANSI/BIFMA standards for safety and performance • Commercial quality backed by 5-Year Warranty • 22.88"W x 21.0"D x 42.88"H •  (SIN 711-18) | Black Fabric | CH57504K | 48 | 6.1 | Yes | \$430.00 |
|  | <p>Multi Function Task Chair</p> <ul style="list-style-type: none"> • 5 Point caster base • Ergonomic design • Pneumatic seat height adjustment • Tilt function with lock and tension adjustment • 360-degree swivel • Height adjustable arm rest • Cushioned black fabric seat and back • Meets ANSI/BIFMA standards for safety and performance • Commercial quality backed by 5-Year Warranty • 22.13"W x 20.5"D x 38.63"H •  (SIN 711-18) | Black Fabric | CH57503K | 51 | 5.5 | Yes | \$460.00 |
|  | <p>Deluxe Multi Function Task Chair</p> <ul style="list-style-type: none"> • 5 Point caster base • Ergonomic design • Pneumatic seat height adjustment • Tilt function and tension adjustment • Infinite locking positions • 360-degree swivel • Height adjustable arm rest • Cushioned black fabric seat and back • Meets ANSI/BIFMA standards for safety and performance • Commercial quality backed by 5-Year Warranty • 22.13"W x 20.5"D x 38.62"H • Not on GSA Contract | Black Fabric | CH57507K | 55 | 5.8 | Yes | \$540.00 |
|  | <p>Soft Caster Pack</p> <ul style="list-style-type: none"> • For use with any 5 Point caster base chair • To be used on any hardwood or other easy-glide surface • 2.2"W x 2.56"D x 3.19"H • Not on GSA Contract | Black Fabric | CHASCAST-ER-03 | 43 | 5.6 | Yes | \$39.00 |

Bookcases

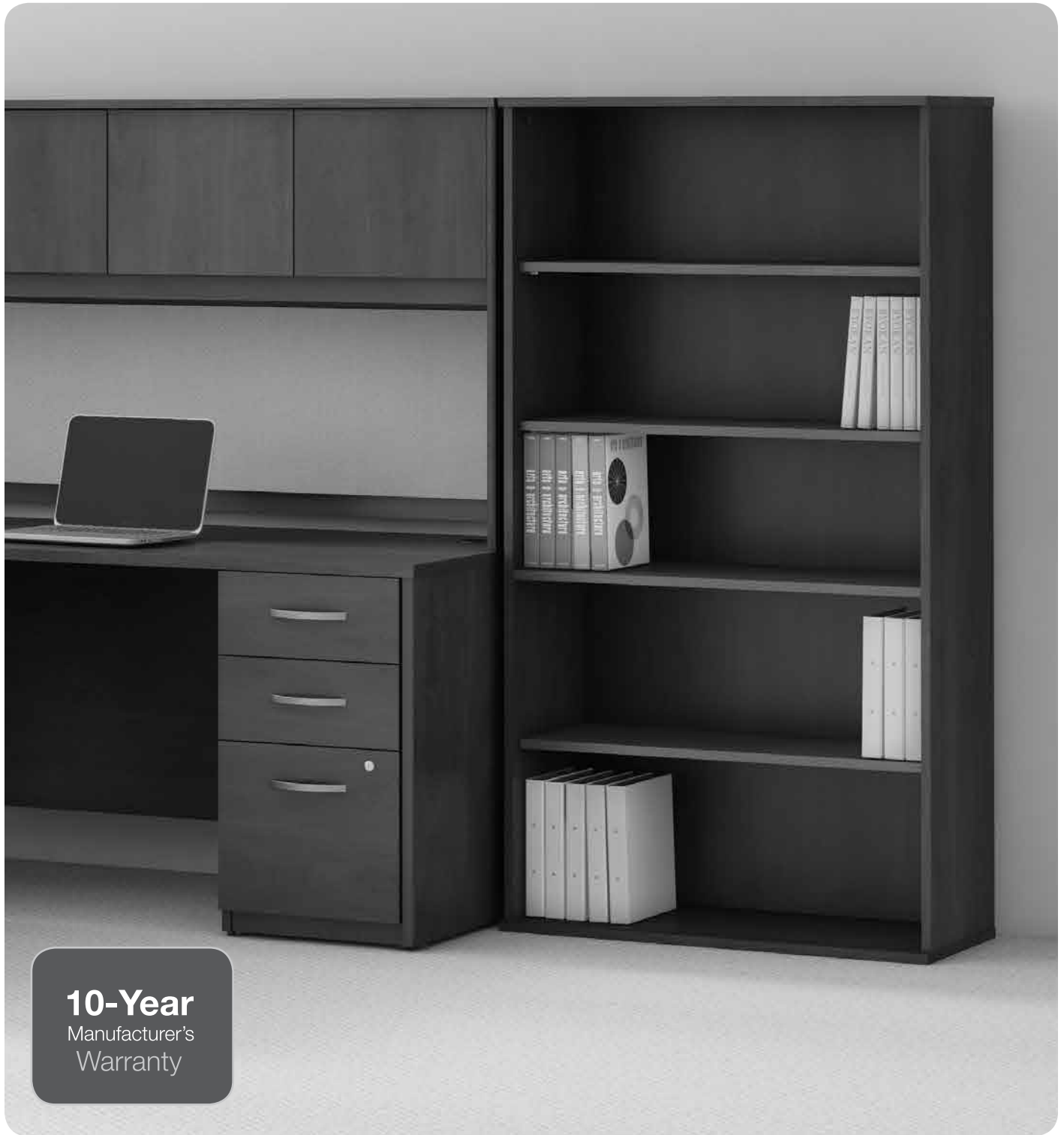









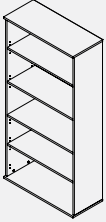

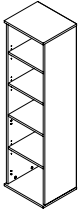
10-Year
Manufacturer's
Warranty

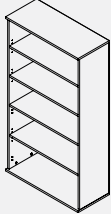
Bookcases

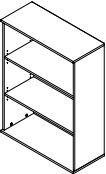
- ☑ Adjustable shelves for storage flexibility
- ☑ Wall attachment hardware included
- ☑ Ideal for books or miscellaneous office supplies

- ☑ Meets ANSI/BIFMA standards for safety and performance
- ☑ Commercial quality backed by a 10-Year Warranty
- ☑ American Made

| | Description | Finish | SKU Number | Shpg Wt. (lbs) | Cube (ft.) | UPS/ Fed Ex | List Price |
|---|---|--|--|----------------|------------|-------------|------------|
|  | <p>72H 5 Shelf Bookcase</p> <ul style="list-style-type: none"> • Three adjustable shelves for storage flexibility • Wall attachment hardware included • 35.71"W x 15.45"D x 72.13"H •  (SIN 711-2) | Harvest Cherry Mocha Cherry Natural Maple Hansen Cherry Natural Cherry | BK7236CS BK7236MR BK7236AC BK7236HC BK7236NC | 109 | 4.9 | Yes | \$375.00 |
|  | <p>66H 5 Shelf Narrow Bookcase</p> <ul style="list-style-type: none"> • Three adjustable shelves for storage flexibility • Wall attachment hardware included • 17.91"W x 15.45"D x 65.87"H •  (SIN 711-2) | Harvest Cherry Mocha Cherry Natural Maple Hansen Cherry Natural Cherry | BK6618CS BK6618MR BK6618AC BK6618HC BK6618NC | 72 | 3.8 | Yes | \$300.00 |
|  | <p>66H 5 Shelf Bookcase</p> <ul style="list-style-type: none"> • Three adjustable shelves for storage flexibility • Wall attachment hardware included • 35.71"W x 15.45"D x 65.87"H •  (SIN 711-2) | Harvest Cherry Mocha Cherry Natural Maple Hansen Cherry Natural Cherry | BK6636CS BK6636MR BK6636AC BK6636HC BK6636NC | 108 | 4.9 | Yes | \$350.00 |
|  | <p>48H 3 Shelf Bookcase</p> <ul style="list-style-type: none"> • Two adjustable shelves for storage flexibility • Wall attachment hardware included • 35.71"W x 15.45"D x 47.99"H •  (SIN 711-2) | Harvest Cherry Mocha Cherry Natural Maple Hansen Cherry Natural Cherry | BK4836CS BK4836MR BK4836AC BK4836HC BK4836NC | 75 | 4.0 | Yes | \$300.00 |
|  | <p>30H 2 Shelf Bookcase</p> <ul style="list-style-type: none"> • One adjustable shelves for storage flexibility • Wall attachment hardware included • 35.71"W x 15.45"D x 29.13"H •  (SIN 711-2) | Harvest Cherry Mocha Cherry Natural Maple Hansen Cherry Natural Cherry | BK3036CS BK3036MR BK3036AC BK3036HC BK3036NC | 49 | 2.6 | Yes | \$200.00 |

Height Adjustable Standing Desks



5-Year
Manufacturer's
Warranty

Height Adjustable Standing Desk Bases



Desk Top Size & Base Placement Guidelines

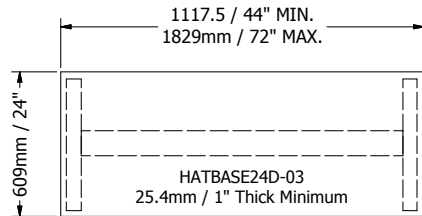
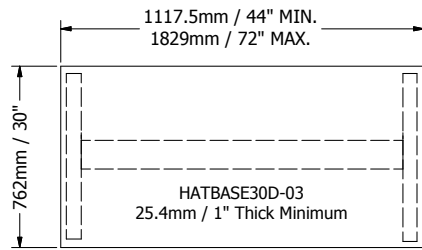







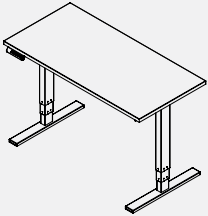

- Height ranges from 23" low to 49" high and operates at speed of 1.5 inches per second
- Use as Table, Return or Bridge
- Weight capacity up to 200 lbs
- Four programmable memory presets with a quiet, soft-touch start and stop
- Input Voltage: 110 Volt, 300-Watts Maximum, Max Current 2.7 A
- Meets ANSI/BIFMA standards for safety and performance
- Integrates easily with other BBF products
- Commercial quality backed by a 5-Year Warranty

| | Description | Finish | SKU Number | Shpg Wt. (lbs) | Cube (ft.) | UPS/ Fed Ex | List Price |
|--|---|---|--------------------------------|----------------|------------|-------------|------------|
| | <p>24D Height Adjustable Standing Desk (Base Only)</p> <ul style="list-style-type: none"> • Tops must be rectangular in shape and centered on base • Width of top must be between 44 and 72" • Depth of top must be 24" • Thickness of top must be between 1 and 1.5" • Input Voltage: 110 Volt, 300-Watts Maximum, Max Current 2.7 A • Quiet UL listed electric motors, 10 ft. power cord plugs into standard wall outlet • Welded 16 gauge steel base legs and feet for superb structural strength • Not on GSA Contract | Cool Gray Metallic Black Powder Coat | HATB24DGM-03K HATB24DBL-03K | 70 | 2.4 | Yes | \$1,400.00 |
| | <p>30D Height Adjustable Standing Desk (Base Only)</p> <ul style="list-style-type: none"> • Tops must be rectangular in shape and centered on base • Width of top must be between 44 and 72" • Depth of top must be 30" • Thickness of top must be between 1 and 1.5" • Input Voltage: 110 Volt, 300-Watts Maximum, Max Current 2.7 A • Quiet UL listed electric motors, 10 ft. power cord plugs into standard wall outlet • Welded 16 gauge steel base legs and feet for superb structural strength • Not on GSA Contract | Cool Gray Metallic Black Powder Coat | HATB30DGM-03K HATB30DBL-03K | 71 | 2.4 | Yes | \$1,400.00 |

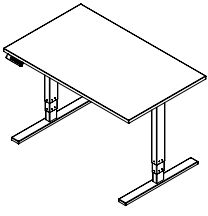

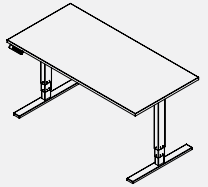

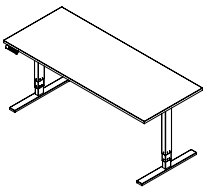
WARNING

Use of this product for desk tops smaller or larger than manufacturer's specified limits will create a safety hazard from, among other things, a loss of strength and/or stability. This safety hazard could result in serious injury or death. Assembly to desktops that do not meet the desktop size guidelines will void warranty. BBF disclaims all liability if product is assembled or used in a manner other than as specified in this price list and/or the assembly and use instructions provided with product.



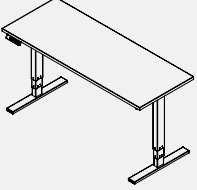

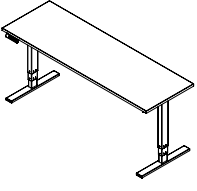
Height Adjustable Standing Desk

| | Description | Finish | Cool Gray Metallic Base-SKU Number | Black Powder Coat Base SKU Number | Shpg Wt. (lbs) | Cube (ft.) | UPS/Fed Ex | List Price |
|---|---|---|---|---|---|---|------------|-------------------|
|  | <p>48W x 24D Height Adjustable Standing Desk Kit</p> <ul style="list-style-type: none"> • Height Adjustable Standing Desk base paired with top surface • Use as Table, Return, or Bridge • American Made •  (SIN 711-2) | <p>Hansen Cherry Natural Cherry Mocha Cherry Satin Mocha Cherry Natural Maple White</p> | <p>HAT4824HCK HAT4824NCK HAT4824MRSK HAT4824MRK HAT4824ACK HAT4824WHK</p> | <p>HAT4824HCBK HAT4824NCBK HAT4824MRSBK HAT4824MRBK HAT4824ACBK HAT4824WHBK</p> | <p>Box 1 37</p> <p>Box 2 70</p> | <p>Box 1 2.5</p> <p>Box 2 2.4</p> | <p>Yes</p> | <p>\$1,610.00</p> |
|  | <p>48W x 30D Height Adjustable Standing Desk Kit</p> <ul style="list-style-type: none"> • Height Adjustable Standing Desk base paired with top surface • Use as Table, Return, or Bridge • American Made •  (SIN 711-2) | <p>Hansen Cherry Natural Cherry Mocha Cherry Satin Mocha Cherry Natural Maple White</p> | <p>HAT4830HCK HAT4830NCK HAT4830MRSK HAT4830MRK HAT4830ACK HAT4830WHK</p> | <p>HAT4830HCBK HAT4830NCBK HAT4830MRSBK HAT4830MRBK HAT4830ACBK HAT4830WHBK</p> | <p>Box 1 45</p> <p>Box 2 71</p> | <p>Box 1 3.1</p> <p>Box 2 2.4</p> | <p>Yes</p> | <p>\$1,625.00</p> |
|  | <p>60W x 30D Height Adjustable Standing Desk Kit</p> <ul style="list-style-type: none"> • Height Adjustable Standing Desk base paired with top surface • Use as Table, Return, or Bridge • American Made •  (SIN 711-2) | <p>Hansen Cherry Natural Cherry Mocha Cherry Satin Mocha Cherry Natural Maple White</p> | <p>HAT6030HCK HAT6030NCK HAT6030MRSK HAT6030MRK HAT6030ACK HAT6030WHK</p> | <p>HAT6030HCBK HAT6030NCBK HAT6030MRSBK HAT6030MRBK HAT6030ACBK HAT6030WHBK</p> | <p>Box 1 56</p> <p>Box 2 71</p> | <p>Box 1 3.7</p> <p>Box 2 2.4</p> | <p>Yes</p> | <p>\$1,652.00</p> |
|  | <p>72W x 30D Height Adjustable Standing Desk Kit</p> <ul style="list-style-type: none"> • Height Adjustable Standing Desk base paired with top surface • Use as Table, Return, or Bridge • American Made •  (SIN 711-2) | <p>Hansen Cherry Natural Cherry Mocha Cherry Satin Mocha Cherry Natural Maple White</p> | <p>HAT7230HCK HAT7230NCK HAT7230MRSK HAT7230MRK HAT7230ACK HAT7230WHK</p> | <p>HAT7230HCBK HAT7230NCBK HAT7230MRSBK HAT7230MRBK HAT7230ACBK HAT7230WHBK</p> | <p>Box 1 66</p> <p>Box 2 71</p> | <p>Box 1 4.4</p> <p>Box 2 2.4</p> | <p>Yes</p> | <p>\$1,737.00</p> |

Height Adjustable Standing Desk Kits (con't)

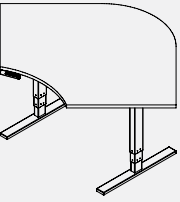

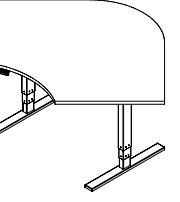

| | Description | Finish | Cool Gray Metallic BaseSKU Number | Black Powder Coat Base SKU Number | Shpg Wt. (lbs) | Cube (ft.) | UPS/ Fed Ex | List Price |
|---|--|---|--|--|---|---|-------------|------------|
|  | <p>60W x 24D Height Adjustable Standing Desk Kit*</p> <ul style="list-style-type: none"> Height Adjustable Standing Desk base paired with top surface Use as Table, Return, or Bridge American Made  (SIN 711-2) | <p>Hansen Cherry Natural Cherry Mocha Cherry Satin Mocha Cherry Natural Maple White</p> | <p>HAT6024HCK HAT6024NCK HAT6024MRSK HAT6024MRK *HAT6024ACK HAT6024WHK</p> | <p>HAT6024HCBK HAT6024NCBK HAT6024MRSBK HAT6024MRBK *HAT6024ACBK HAT6024WHBK</p> | <p>Box 1 37</p> <p>Box 2 70</p> | <p>Box 1 2.5</p> <p>Box 2 2.4</p> | Yes | \$1,638.00 |
|  | <p>72W x 24D Height Adjustable Standing Desk Kit*</p> <ul style="list-style-type: none"> Height Adjustable Standing Desk base paired with top surface Use as Table, Return, or Bridge American Made  (SIN 711-2) | <p>Hansen Cherry Natural Cherry Mocha Cherry Satin Mocha Cherry Natural Maple White</p> | <p>HAT7224HCK HAT7224NCK HAT7224MRSK HAT7224MRK *HAT7224ACK HAT7224WHK</p> | <p>HAT7224HCBK HAT7224NCBK HAT7224MRSBK HAT7224MRBK *HAT7224ACBK HAT7224WHBK</p> | <p>Box 1 45</p> <p>Box 2 71</p> | <p>Box 1 3.1</p> <p>Box 2 2.4</p> | Yes | \$1,707.00 |

***Modern Cherry and Natural Maple finishes are special order only. Please call for details.**

| | | | | | | | | |
|---|---|---|--|---|---|---|-----|------------|
|  | <p>48W x 48D x 24D Corner Height Adjustable Standing Desk Kit*</p> <ul style="list-style-type: none"> Height Adjustable Standing Desk base paired with top surface Use as Table, Return, or Bridge American Made  (SIN 711-2) | <p>Hansen Cherry Natural Cherry Mocha Cherry Satin Mocha Cherry Natural Maple White</p> | <p>*HAT484824HCK HAT484824NCK *HAT484824MRSK *HAT484824MRK *HAT484824ACK HAT484824WHK</p> | <p>*HAT484824HCBK HAT484824NCBK *HT484824MRSBK *HAT484824MRBK *HAT484824ACBK HAT484824WHBK</p> | <p>Box 1 56</p> <p>Box 2 71</p> | <p>Box 1 3.7</p> <p>Box 2 2.4</p> | Yes | \$1,771.00 |
|  | <p>48W x 48D x 30D Corner Height Adjustable Standing Desk Kit*</p> <ul style="list-style-type: none"> Height Adjustable Standing Desk base paired with top surface Use as Table, Return, or Bridge American Made  (SIN 711-2) | <p>Hansen Cherry Natural Cherry Mocha Cherry Satin Mocha Cherry Natural Maple White</p> | <p>*HAT484830HCK HAT484830NCK *HAT484830MRSK *HAT484830MRK *HAT484830ACK *HAT484830WHK</p> | <p>*HAT484830HCBK HAT484830NCBK *HT484830MRSBK *HAT484830MRBK *HAT484830ACBK *HAT484830WHBK</p> | <p>Box 1 66</p> <p>Box 2 71</p> | <p>Box 1 4.4</p> <p>Box 2 2.4</p> | Yes | \$1,807.00 |

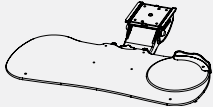
***Some Corner Height Adjustable Standing Desks are special order. Please call for details.**

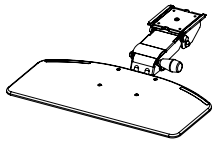
Height Adjustable Standing Desk (Accessories)

| | Description | Finish | SKU Number | Shpg Wt. (lbs) | Cube (ft.) | UPS/ Fed Ex | List Price |
|---|--|--------|-------------|----------------|------------|-------------|------------|
|  | <p>Deluxe Articulating Keyboard Tray Kit (Height Adjustable Standing Desk)</p> <ul style="list-style-type: none"> • Made specifically for use with BBF Height Adjustable Standing Desks • Position indicators for both height and tilt • Soft-touch wheel allows convenient one handed tilt adjustment • Total vertical range of 8" (3" above to 5" below Work Surface) • Total horizontal (in/out travel) range of 15" • Capable of 30° of tilt adjustment (20° negative to 10° positive) • Positive tilt lock out pin included • "Lift and release" height adjustment • Removable wrist rest with easy-to-clean cover • Mouse pad included • Additional wire management clips and mouse fence included • 27"W x 11"D x 1.2"H •  (SIN 711-2) | Black | ACHAT99889K | 16 | 1.4 | Yes | \$565.00 |
|  | <p>Articulating Keyboard Tray Kit (Height Adjustable Standing Desk)</p> <ul style="list-style-type: none"> • Made specifically for use with BBF Height Adjustable Standing Desks • Retracts under desk surface when not in use • 5.3" height adjustable range (knobless) • Capable of 27° of tilt adjustment (17° negative to 10° positive) • 15" of forward-backward travel • Swivels 180° left and right • 24.57"W x 19.5"D x 3.63"H •  (SIN 711-2) | Galaxy | ACHAT99801K | 13 | 0.7 | Yes | \$329.00 |

Conference Tables



10-Year
Manufacturer's
Warranty

Aspen – Conference Tables

- Thermally fused Work Surfaces resist scratches and stains
- Finished underside prevents snagged clothing
- Durable edge band stands up to years of use
- Metal post-type legs include leveling glide
- Includes all connectors and mounting plates for installation
- Covered by BBF's 10-Year Warranty







| | Description | Finish | SKU Number | Shpg Wt. (lbs) | Cube (ft.) | UPS/ Fed Ex | List Price |
|---|--|---------------------------------|--------------------|----------------|------------|-------------|------------|
|  | <p>28½ W Square Table</p> <ul style="list-style-type: none"> • 28.35"W x 28.35"D x 28.95"H •  (SIN 711-11) | White Spectrum Hansen Cherry | TS85200 TS85400 | 43 | 4.4 | Yes | \$335.00 |
|  | <p>48W x 28½ D Rectangle Table</p> <ul style="list-style-type: none"> • Accepts Universal Keyboard Shelf • 47.24"W x 28.35"D x 28.95"H •  (SIN 711-11) | White Spectrum Hansen Cherry | TS85201 TS85401 | 59 | 6.8 | Yes | \$389.00 |
|  | <p>57W x 28½ D Rectangle Table</p> <ul style="list-style-type: none"> • Accepts Universal Keyboard Shelf • 56.69"W x 28.35"D x 28.95"H •  (SIN 711-11) | White Spectrum Hansen Cherry | TS85202 TS85402 | 67 | 8.0 | Yes | \$433.00 |
|  | <p>57W x 24¾ D Trapezoid Table</p> <ul style="list-style-type: none"> • Accepts Universal Keyboard Shelf • 56.69"W x 24.55"D x 28.95"H •  (SIN 711-11) | White Spectrum Hansen Cherry | TS85203 TS85403 | 52 | 6.8 | Yes | \$477.00 |
|  | <p>28½ W Corner Connector</p> <ul style="list-style-type: none"> • Use to connect and combined tables • Not freestanding • 28.35"W x 28.35"D x 1"H •  (SIN 711-11) | White Spectrum Hansen Cherry | TS85204 TS85404 | 19 | 1.0 | Yes | \$185.00 |

BBF Conference Tables

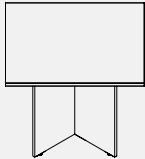

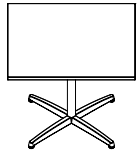

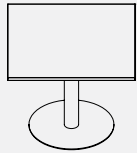

- Durable 100% thermally fused laminate Work Surfaces resist scratches and stains
- All Square and Round Conference Tables seat 4 people

- All boat-shaped tops include 2" diameter grommets for wire management
- Covered by BBF's Limited Lifetime Warranty



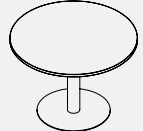

36 Square Conference Tables (3 base options)

| | Description | Finish | SKU Number | Shpg Wt. (lbs) | Cube (ft.) | UPS/Fed Ex | List Price |
|--|---|---|---|---|--|------------|------------|
|  | 36 Square Conference Table (Wood Base) <ul style="list-style-type: none"> • 35.79"W x 35.79"D x 29.66"H •  (SIN 711-11) | Harvest Cherry Mocha Cherry Natural Maple | 99TB3636CS 99TB3636MR 99TB3636AC | 70 | 3 | Yes | \$414.00 |
|  | 36 Square Conference Table (Metal X Base) <ul style="list-style-type: none"> • 35.79"W x 35.79"D x 29.66"H • Ships in two boxes •  (SIN 711-11) | Harvest Cherry Mocha Cherry Natural Maple | 99TBX36SCSSVK 99TBX36SMRSVK 99TBX36SACSVK | Box 1 39 Box 2 22 | Box 1 1.9 Box 1 2.5 | Yes | \$603.00 |
|  | 36 Square Conference Table (Metal Disc Base) <ul style="list-style-type: none"> • 35.79"W x 35.79"D x 29.66"H • Ships in three boxes •  (SIN 711-11) | Harvest Cherry Mocha Cherry Natural Maple | 99TBD36SCSSVK 99TBD36SMRSVK 99TBD36SACSVK | Box 1 39 Box 2 19 Box 3 33 | Box 1 1.9 Box 2 2.5 Box 3 1.0 | Yes | \$896.00 |



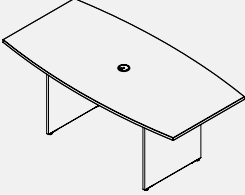

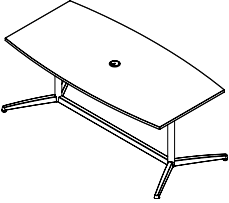
42 Round Conference Tables (3 base options)

| | Description | Finish | SKU Number | Shpg Wt. (lbs) | Cube (ft.) | UPS/Fed Ex | List Price |
|---|--|--|--|--|--|------------|------------|
|  | 42 Round Conference Tables (Wood Base) <ul style="list-style-type: none"> • 41.38"W x 41.38"D x 29.66"H •  (SIN 711-11) | Harvest Cherry Mocha Cherry Natural Maple Hansen Cherry | 99TB42RCS 99TB42RMR 99TB42RAC 99TB42RHC | 73 | 3.7 | Yes | \$459.00 |
|  | 42 Round Conference Table (Metal X Base) <ul style="list-style-type: none"> • 41.38"W x 41.38"D x 29.66"H • Ships in two boxes •  (SIN 711-11) | Harvest Cherry Mocha Cherry Natural Maple | 99TBX42RCSSVK 99TBX42RMRSVK 99TBX42RACSVK | Box 1 39 Box 2 22 | Box 1 2.1 Box 1 2.5 | Yes | \$650.00 |
|  | 42 Round Conference Table (Metal Disc Base) <ul style="list-style-type: none"> • 41.38"W x 41.38"D x 29.66"H • Ships in three boxes •  (SIN 711-11) | Harvest Cherry Mocha Cherry Natural Maple | 99TBD42RCSSVK 99TBD42RMRSVK 99TBD42RACSVK | Box 1 39 Box 2 19 Box 3 3.3 | Box 1 2.1 Box 2 2.5 Box 3 1.0 | Yes | \$943.00 |



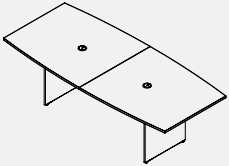

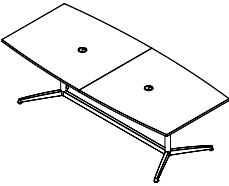
72L x 36W Boat Top Conference Tables (2 base options)

| | Description | Finish | SKU Number | Shpg Wt. (lbs) | Cube (ft.) | UPS/ Fed Ex | List Price |
|---|--|--|--|--|---|-------------|------------|
|  | 72L x 36W Boat Top Conference Table (Wood Base) <ul style="list-style-type: none"> • 35.98"W x 71.54"D x 28.65"H • Seats 4–6 people •  (SIN 711-11) | Harvest Cherry Mocha Cherry Natural Maple Hansen Cherry | 99TB7236CS 99TB7236MR 99TB7236AC 99TB7236HC | 114 | 5.9 | Yes | \$716.00 |
|  | 72L x 36W Boat Top Conference Table (Metal Base) <ul style="list-style-type: none"> • 35.98"W x 71.54"D x 28.65"H • Seats 4–6 people • Ships in four boxes •  (SIN 711-11) | Harvest Cherry Mocha Cherry Natural Maple | 99TBM72CSSVK 99TBM72MRSVK 99TBM72ACSVK | Box 1 74 Box 2 21 Box 3 21 Box 4 10 | Box 1 4.1 Box 2 2.5 Box 3 2.5 Box 4 .6 | Yes | \$1,252.00 |

96L x 42W Boat Top Conference Tables (2 base options)

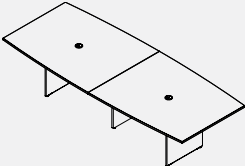
| | Description | Finish | SKU Number | Shpg Wt. (lbs) | Cube (ft.) | UPS/ Fed Ex | List Price |
|---|--|---|--|---|---|-------------|------------|
|  | 96L x 42W Boat Top Conference Table (Wood Base) <ul style="list-style-type: none"> • 42.01"W x 95.20"D x 29.78"H • Ships in two boxes • Seats 6–8 people •  (SIN 711-11) | Harvest Cherry Mocha Cherry Natural Maple | 99TB9642CSK 99TB9642MRK 99TB9642ACK | Box 1 108 Box 2 45 | Box 1 5.1 Box 1 2.8 | Yes | \$835.00 |
|  | 96L x 42W Boat Top Conference Table (Metal Base) <ul style="list-style-type: none"> • 42.01"W x 95.20"D x 29.78"H • Ships in four boxes • Seats 6–8 people •  (SIN 711-11) | Harvest Cherry Mocha Cherry Natural Maple | 99TBM96CSSVK 99TBM96MRSVK 99TBM96ACSVK | Box 1 108 Box 2 21 Box 3 21 Box 4 15 | Box 1 5.1 Box 2 2.5 Box 3 2.5 Box 4 .6 | Yes | \$1,564.00 |

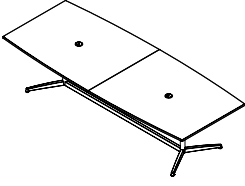
120L x 48W Boat Top Conference Tables (2 base options)

| | Description | Finish | SKU Number | Shpg Wt. (lbs) | Cube (ft.) | UPS/ Fed Ex | List Price |
|---|--|---|---|---|---|-------------|------------|
|  | 120L x 48W Boat Top Conference Table (Wood Base) <ul style="list-style-type: none"> • 47.6"W x 119.21"D x 29.78"H • Ships in two boxes • Seats 8–10 people •  (SIN 711-11) | Harvest Cherry Mocha Cherry Natural Maple | 99TB12048CSK 99TB12048MRK 99TB12048ACK | Box 1 158 Box 2 61 | Box 1 7 Box 1 3.2 | No | \$1,185.00 |
|  | 120L x 48W Boat Top Conference Table (Metal Base) <ul style="list-style-type: none"> • 47.6"W x 119.21"D x 29.78"H • Ships in four boxes • Seats 8–10 people •  (SIN 711-11) | Harvest Cherry Mocha Cherry Natural Maple | 99TBM120CSSVK 99TBM120MRSVK 99TBM120ACSVK | Box 1 158 Box 2 21 Box 3 21 Box 4 16 | Box 1 7 Box 2 2.5 Box 3 2.5 Box 4 .8 | No | \$1,838.00 |

Accessories

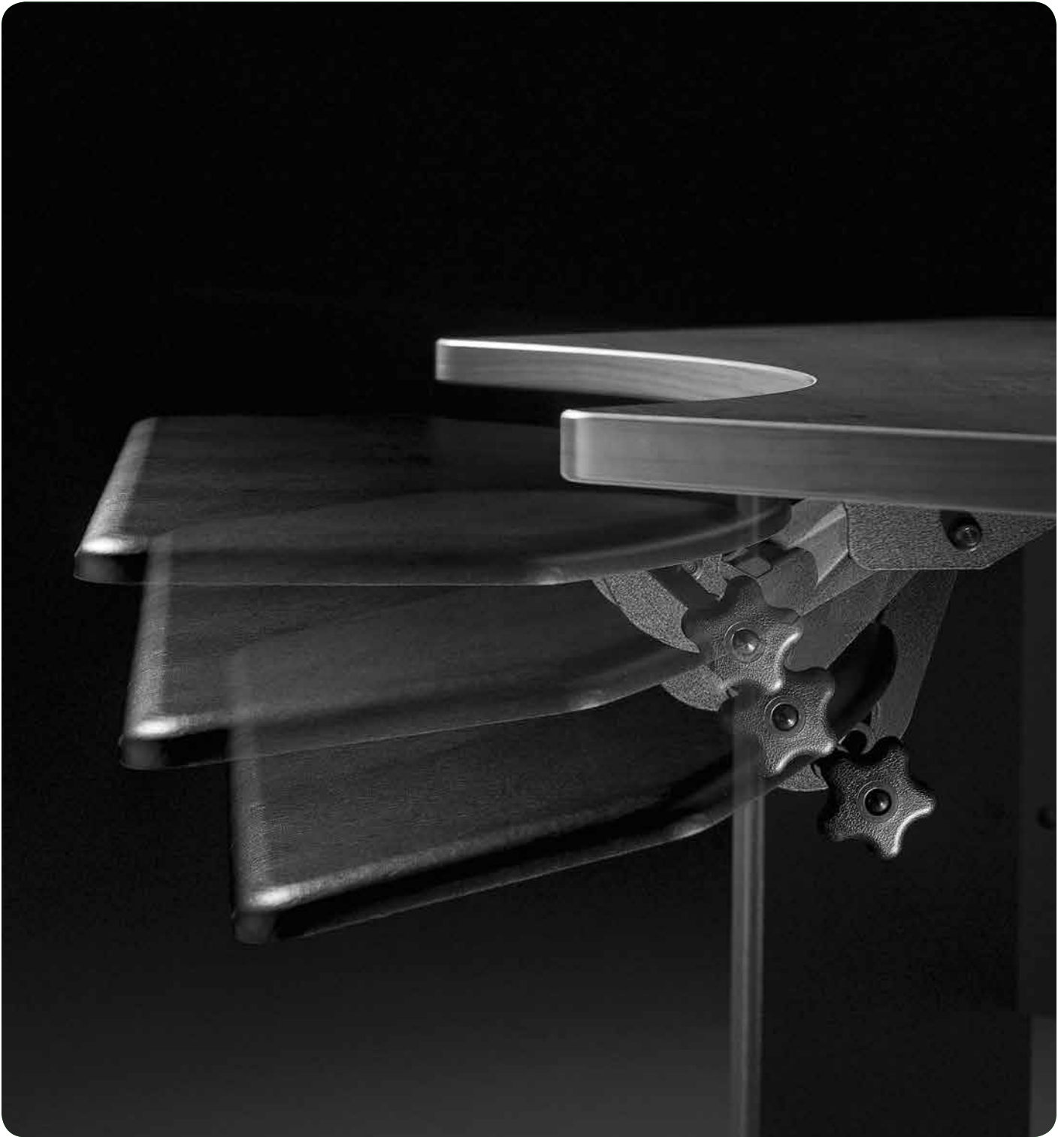





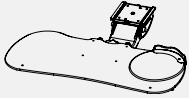

Accessory Compatibility Chart

This chart is for general compatibility. Varies by specific SKU.

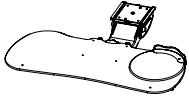

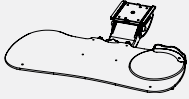
| | Momentum | Milano2 | Quantum™ | Realize™ | Enterprise | Syndicate | Aspen Tables | Series C Elite | Series C | Series A | Office in an Hour | Venture | Height Adjustable Standing Desks |
|---|-------------------------------------|-------------------------------------|-------------------------------------|-------------------------------------|-------------------------------------|-------------------------------------|-------------------------------------|-------------------------------------|-------------------------------------|-------------------------------------|-------------------------------------|-------------------------------------|-------------------------------------|
| Deluxe Articulating Keyboard Tray (long track) (AC99889) | <input checked="" type="checkbox"/> | <input checked="" type="checkbox"/> | <input checked="" type="checkbox"/> | <input checked="" type="checkbox"/> | <input checked="" type="checkbox"/> | <input checked="" type="checkbox"/> | | <input checked="" type="checkbox"/> | <input checked="" type="checkbox"/> | <input checked="" type="checkbox"/> | <input checked="" type="checkbox"/> | <input checked="" type="checkbox"/> | |
| Deluxe Articulating Keyboard Tray (med track) (AC99887) | | <input checked="" type="checkbox"/> | | <input checked="" type="checkbox"/> | | | | | | | | | |
| Deluxe Articulating Keyboard Tray (short track) (AC99888) | | | | | | | | | | | | | |
| Articulating Keyboard Tray (AC99801-03) | <input checked="" type="checkbox"/> | <input checked="" type="checkbox"/> | <input checked="" type="checkbox"/> | <input checked="" type="checkbox"/> | <input checked="" type="checkbox"/> | <input checked="" type="checkbox"/> | | <input checked="" type="checkbox"/> | <input checked="" type="checkbox"/> | <input checked="" type="checkbox"/> | <input checked="" type="checkbox"/> | <input checked="" type="checkbox"/> | |
| Universal Keyboard Shelf (AC99808-03) | | <input checked="" type="checkbox"/> | <input checked="" type="checkbox"/> | <input checked="" type="checkbox"/> | <input checked="" type="checkbox"/> | <input checked="" type="checkbox"/> | <input checked="" type="checkbox"/> | <input checked="" type="checkbox"/> | <input checked="" type="checkbox"/> | <input checked="" type="checkbox"/> | | | |
| Task Light (WC8065C-03) | | <input checked="" type="checkbox"/> | <input checked="" type="checkbox"/> | <input checked="" type="checkbox"/> | <input checked="" type="checkbox"/> | <input checked="" type="checkbox"/> | | <input checked="" type="checkbox"/> | <input checked="" type="checkbox"/> | <input checked="" type="checkbox"/> | | | |
| Multi-purpose Drawer with Drop Front (WC99855-03) | | <input checked="" type="checkbox"/> | <input checked="" type="checkbox"/> | <input checked="" type="checkbox"/> | <input checked="" type="checkbox"/> | <input checked="" type="checkbox"/> | <input checked="" type="checkbox"/> | <input checked="" type="checkbox"/> | <input checked="" type="checkbox"/> | <input checked="" type="checkbox"/> | | | |
| Pencil Drawer (AC99850) | | <input checked="" type="checkbox"/> | <input checked="" type="checkbox"/> | <input checked="" type="checkbox"/> | <input checked="" type="checkbox"/> | <input checked="" type="checkbox"/> | <input checked="" type="checkbox"/> | <input checked="" type="checkbox"/> | <input checked="" type="checkbox"/> | <input checked="" type="checkbox"/> | | | |
| Data/Power HUB (AC99840-03) | <input checked="" type="checkbox"/> | <input checked="" type="checkbox"/> | <input checked="" type="checkbox"/> | <input checked="" type="checkbox"/> | <input checked="" type="checkbox"/> | <input checked="" type="checkbox"/> | <input checked="" type="checkbox"/> | <input checked="" type="checkbox"/> | <input checked="" type="checkbox"/> | <input checked="" type="checkbox"/> | <input checked="" type="checkbox"/> | <input checked="" type="checkbox"/> | |
| CPU Holder (AC99820-03) | | | <input checked="" type="checkbox"/> | | | | | | | | | | |
| Monitor Arm with Post (AC99830-03) | | | <input checked="" type="checkbox"/> | | | | | <input checked="" type="checkbox"/> | <input checked="" type="checkbox"/> | | | | |
| Universal Grommet Set (AC99845) | <input checked="" type="checkbox"/> | <input checked="" type="checkbox"/> | <input checked="" type="checkbox"/> | <input checked="" type="checkbox"/> | <input checked="" type="checkbox"/> | <input checked="" type="checkbox"/> | <input checked="" type="checkbox"/> | <input checked="" type="checkbox"/> | <input checked="" type="checkbox"/> | <input checked="" type="checkbox"/> | <input checked="" type="checkbox"/> | <input checked="" type="checkbox"/> | |
| Universal Lock Set (AC99823 & AC99826) | | | | <input checked="" type="checkbox"/> | | | | <input checked="" type="checkbox"/> | <input checked="" type="checkbox"/> | <input checked="" type="checkbox"/> | | | |
| Universal Wire Tray (AC99865) | | <input checked="" type="checkbox"/> | <input checked="" type="checkbox"/> | <input checked="" type="checkbox"/> | <input checked="" type="checkbox"/> | <input checked="" type="checkbox"/> | <input checked="" type="checkbox"/> | | <input checked="" type="checkbox"/> | <input checked="" type="checkbox"/> | | <input checked="" type="checkbox"/> | |
| Deluxe Articulating Keyboard Tray Kit (Height Adjustable Standing Desk) (ACHAT99889K) | | | | | | | | | | | | | <input checked="" type="checkbox"/> |
| Articulating Keyboard Tray Kit (Height Adjustable Standing Desk) (ACHAT99801K) | | | | | | | | | | | | | <input checked="" type="checkbox"/> |

Accessories (con't)





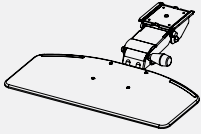

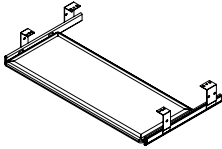
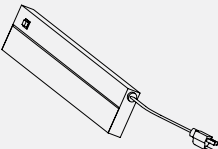
| | Description | Finish | SKU Number | Shpg Wt. (lbs) | Cube (ft.) | UPS/ Fed Ex | List Price |
|---|---|--------|------------|----------------|------------|-------------|------------|
|  | <p>Deluxe Articulating Keyboard Tray (Long Track)</p> <ul style="list-style-type: none"> • Position indicators for both height and tilt • Soft-touch wheel allows convenient one handed tilt adjustment • Total vertical range of 8" (3" above to 5" below Work Surface) • Total horizontal (in/out travel) range of 15" • Capable of 30° of tilt adjustment (20° negative to 10° positive) • Positive tilt lock out pin included • "Lift and release" height adjustment • Removable wrist rest with easy to clean cover • Mouse pad included • Additional wire management clips and mouse fence included • 27"W x 11"D x 1.2"H •  (SIN 711-2) | Black | AC99889 | 16 | 1.4 | Yes | \$506.00 |
|  | <p>Deluxe Articulating Keyboard Tray (Med Track)</p> <ul style="list-style-type: none"> • Position indicators for both height and tilt • Soft-touch wheel allows convenient one handed tilt adjustment • Total vertical range of 8" (3" above to 5" below Work Surface) • Total horizontal (in/out travel) range of 11.13" • Capable of 30° of tilt adjustment (20° negative to 10° positive) • Positive tilt lock out pin included • "Lift and release" height adjustment • Removable wrist rest with easy to clean cover • Mouse pad included • Additional wire management clips and mouse fence included • 27"W x 16.88"D x 1.2"H •  (SIN 711-2) | Black | AC99887 | 16 | 1.4 | Yes | \$484.00 |
|  | <p>Deluxe Articulating Keyboard Tray (Short Track)</p> <ul style="list-style-type: none"> • Position indicators for both height and tilt • Soft-touch wheel allows convenient one handed tilt adjustment • Total vertical range of 8" (3" above to 5" below Work Surface) • Total horizontal (in/out travel) range of 11.13" • Capable of 30° of tilt adjustment (20° negative to 10° positive) • Positive tilt lock out pin included • "Lift and release" height adjustment • Removable wrist rest with easy to clean cover • Mouse pad included • Additional wire management clips and mouse fence included • 27"W x 11.00"D x 1.2"H •  (SIN 711-2) | Black | AC99888 | 16 | 1.4 | Yes | \$506.00 |

***See Page 103 for Keyboard Trays compatible with Height Adjustable Standing Desks**

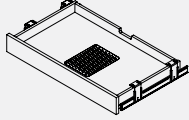
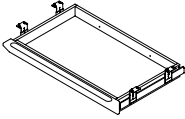

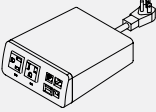
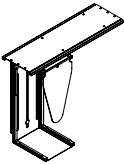
Accessories (con't)

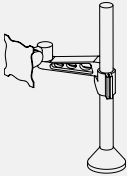
| | Description | Finish | SKU Number | Shpg Wt. (lbs) | Cube (ft.) | UPS/Fed Ex | List Price |
|---|---|--------|------------|----------------|------------|------------|------------|
|  | <p>Articulating Keyboard Tray (Long Track)</p> <ul style="list-style-type: none"> • Retracts under Desk surface when not in use • 5.3" height adjustable range (knobless) • Capable of 27° of tilt adjustment (17° negative to 10° positive) • 15" of forward-backward travel • Swivels 180° left and right • 24.57"W x 19.5"D x 3.63"H •  (SIN 711-2) | Galaxy | AC99801-03 | 13 | 0.7 | Yes | \$270.00 |
|  | <p>Universal Keyboard Shelf</p> <ul style="list-style-type: none"> • Mounts under Quantum Desks • Holds Keyboard and mouse • 30.12"W x 16.58"D x 3.97"H • Not on GSA Contract | Galaxy | AC99808-03 | 10 | 0.8 | Yes | \$131.00 |
|  | <p>Task Light</p> <ul style="list-style-type: none"> • Mounts on most Hutches • 8' Cord Length • 23.27"W x 3.44"D x 1.48"H • Not on GSA Contract | Pewter | WC8065C-03 | 3 | 0.2 | Yes | \$126.00 |

Accessories (con't)

| | Description | Finish | SKU Number | Shpg Wt. (lbs) | Cube (ft.) | UPS/ Fed Ex | List Price |
|---|--|--------------|-------------|----------------|------------|-------------|------------|
|  | <p>Multi-purpose Drawer with Drop Front</p> <ul style="list-style-type: none"> Multi-function can be used as a Keyboard Drawer, Laptop Docking Station, or Pencil Drawer Drop design drawer front Ventilated bottom shelf allows air flow 27.01"W x 17.36"D x 3.58"H Not on GSA Contract | Black | AC99855-03 | 17 | 1.7 | Yes | \$218.00 |
|  | <p>Pencil Drawer</p> <ul style="list-style-type: none"> Sloped front for reduced visibility and visual appeal Height-adjustable brackets 3/4-extension, ball-bearing slides 26.37"W x 15.88"D x 2.63"H  (SIN 711-2) | Black | AC99850 | 11 | 0.8 | Yes | \$179.00 |
|  | <p>Data/Power HUB</p> <ul style="list-style-type: none"> Integrated power surge protection Front of unit contains: <ul style="list-style-type: none"> Two 120 VAC power outlets One phone jack One CAT5 Ethernet and one fire wire port Two USB ports Rear of unit contains <ul style="list-style-type: none"> One matching data port, one phone jack, one USB port 10' heavy-duty grounded power cord 5.49"W x 6.3"D x 2.32"H Not on GSA Contract | Satin Nickel | AC99840-03 | 3 | 0.1 | Yes | \$158.00 |
|  | <p>CPU Holder</p> <ul style="list-style-type: none"> Mounts on underside of any Work Surfaces except Bridges Pivots 360°, extends or retracts on ball-bearing slides within a 7" range, fits CPUs up to 20.5"H x 8.25"W and weighing up to 50 lbs. 9.06"W x 14.02"D x 22.52"H Mounts under Quantum Work Surfaces only  (SIN 711-2) | Black | AC99820-03 | 10 | 0.5 | Yes | \$172.00 |
|  | <p>Monitor Arm with Post</p> <ul style="list-style-type: none"> Mounts on any 3" wire management grommets Allows monitor to tilt, swivel and rotate Will accommodate most flat panel monitors up to 20" with Vesa 100 mm mounting holes Has steel post with aluminum arm and 13" height adjustment range 12.8"W x 13.98"D x 20.47"H  (SIN 711-2) | Satin Nickel | AC99830B-03 | 8 | 0.5 | Yes | \$180.00 |

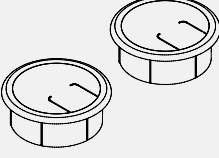
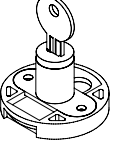
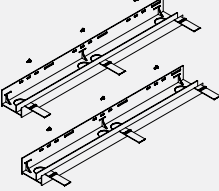
Accessories (con't)

| | Description | Finish | SKU Number | Shpg Wt. (lbs) | Cube (ft.) | UPS/Fed Ex | List Price |
|---|--|-----------------|--------------------|----------------|------------|------------|------------|
|  | <p>Universal Grommet Set</p> <ul style="list-style-type: none"> • Allows for easy routing of cables through desk top • Easy to follow template • Includes 2 grommets per kit • Remove top to pass large connectors • Commercial quality backed by Limited Lifetime Warranty • Not on GSA Contract | Black | AC99845 | | | Yes | \$27.00 |
|  | <p>Universal Lock Set</p> <ul style="list-style-type: none"> • Chrome Lock Set adds security to any Series A, Series C or Series C Elite Hutch door • Black Lock Set adds security to any Realize Hutch door • Easy to follow template • All locks keyed alike • Different lock core/key sets available to allow multiple office settings to have their own key for increased security • Meets ANSI/BIFMA standards for safety and performance • AC99823 works with Series C, Series C Elite, and Series A • AC99826 works with Realize only • Commercial quality backed by Limited Lifetime Warranty • Not on GSA Contract | Chrome Black | AC99823 AC99826 | | | Yes | \$43.00 |
|  | <p>Universal Wire Tray</p> <ul style="list-style-type: none"> • Channels provides a versatile cable management system • Set consists of two trays • Features a divider to separate data cables from power cords • Flexible straps secure cords and cables • Includes two trays per kit • East to install with three self-tapping screws • Commercial quality backed by Limited Lifetime Warranty •  (SIN 711-2) | Gray | AC99865 | | | Yes | \$51.00 |

Metal Filing



Limited
Lifetime
Warranty





Synchronize Series 1000V

- 3/4-extension drawers with ball-bearing suspensions
- Barrel-style lock mechanism with removable core, comes standard with two keys
- Drawers accommodate letter-sized files
- Designed to fit underneath a desk
- Removable drawer fronts
- Aluminum drawer pulls with thumb-activated drawer latch
- Aluminum label holders are standard
- Galvanized steel protects against rust and corrosion
- Meets ANSI/BIFMA test standards for commercial office furniture
- Limited Lifetime Warranty

| | Description | Finish | SKU Number | Shpg Wt. (lbs) | Cube (ft.) | UPS/Fed Ex | List Price |
|---|--|----------------|--------------------|----------------|------------|------------|------------|
|  | 2 Drawer Vertical Metal File <ul style="list-style-type: none"> • 15"W x 25"D x 28.37"H •  (SIN 711-3) | Black Putty | 80FV2BK 80FV2PY | 47 | 12.0 | No | \$386.00 |

Synchronize Series 1000L

- One removable core lock for both drawers, with dual locking bars for added security
- Anti-tip mechanism prevents more than one drawer from opening at a time
- Removable drawer fronts
- Full-extension drawers with ball-bearing suspensions
- Drawers accommodate letter, legal, and A4-sized files
- Leveling glides compensate for uneven floors
- Magnetic drawer contents identifier
- Fully finished bases
- Meets ANSI/BIFMA test standards for commercial office furniture
- Limited Lifetime Warranty

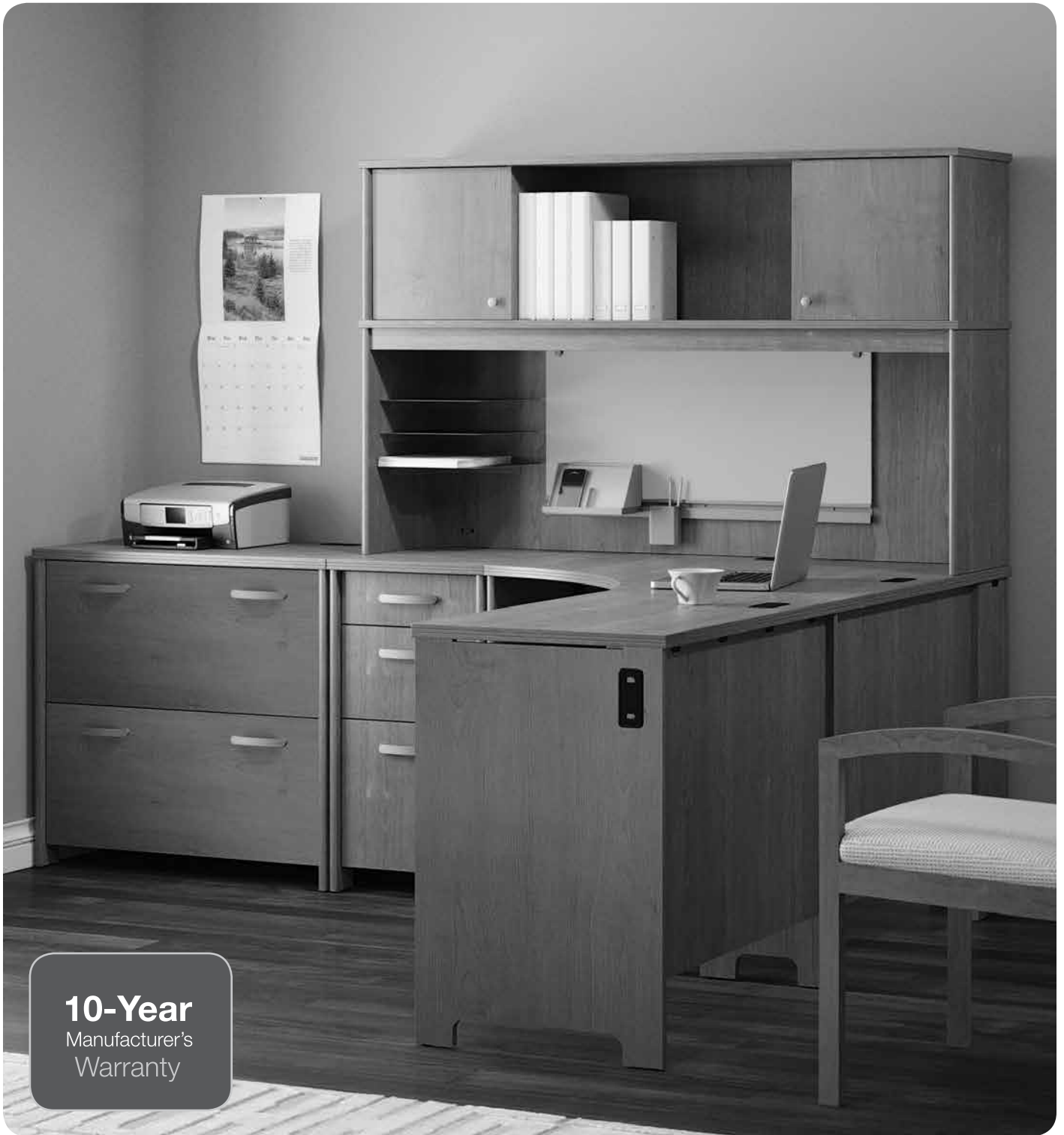

| | Description | Finish | SKU Number | Shpg Wt. (lbs) | Cube (ft.) | UPS/Fed Ex | List Price |
|---|---|----------------|------------------------|----------------|------------|------------|------------|
|  | 36W 2 Drawer Lateral Metal File <ul style="list-style-type: none"> • 36"W x 18.63"D x 28"H •  (SIN 711-3) | Black Putty | 80FL236BK 80FL236PY | 124 | 14.2 | No | \$803.00 |
|  | 36W 4 Drawer Lateral Metal File <ul style="list-style-type: none"> • 36"W x 18.63"D x 52.5"H •  (SIN 711-3) | Black Putty | 80FL436BK 80FL436PY | 175 | 25.8 | No | \$1,095.00 |

Envoy

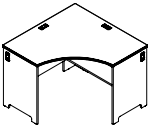
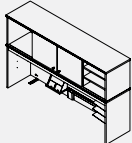

10-Year
Manufacturer's
Warranty

- Durable, thermally fused laminate Work Surface
- Grooved edge banding accents
- Cable ties underneath Desk keep wires organized
- Stylish profiled edge details on uprights
- Finished approach side allows placement in middle of room
- Charging/organization tray on pullout shelf helps reduce clutter and keeps electronics under control
- Integrated 4-port USB Hub to bring connectivity to the Work Surface
- Full-extension file drawer with ball-bearing slides accommodates letter and legal-sized files
- Hutch includes Tackboard and work-in-process trays
- Backed by 10-Year Manufacturer's Warranty

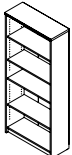
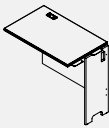
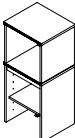
| | Description | Finish | SKU Number | Shpg Wt. (lbs) | Cube (ft.) | UPS/Fed Ex | List Price |
|---|--|---|----------------------------------|----------------------------|------------------------------|------------|------------|
|  | Double Pedestal Desk* <ul style="list-style-type: none"> • Ships in 2 Boxes • 57.99"W x 23.19"D x 30.2"H • Box drawer feature 3/4 ball-bearing slides • Not on GSA Contract | Hansen Cherry Natural Cherry Mocha Cherry | PR76560K PR76360K PR76860K | Box 1 74 Box 2 85 | Box 1 2.6 Box 1 3.1 | Yes | \$660.00 |
|  | Corner Desk* <ul style="list-style-type: none"> • 42.01"W x 42.01"D x 30.2"H • Not on GSA Contract | Hansen Cherry Natural Cherry Mocha Cherry | PR76520 PR76320 PR76820 | 105 | 4.9 | Yes | \$450.00 |
|  | Hutch* <ul style="list-style-type: none"> • 57.99"W x 14.17"D x 36.14"H • Not on GSA Contract | Hansen Cherry Natural Cherry Mocha Cherry | PR76561 PR76361 PR76861 | 117 | 5 | Yes | \$506.00 |
|  | Three Drawer Pedestal* <ul style="list-style-type: none"> • 15.98"W x 20"D x 30.2"H • Box drawer feature 3/4 ball-bearing slides • Not on GSA Contract | Hansen Cherry Natural Cherry Mocha Cherry | PR76580 PR76380 PR76880 | 66 | 2.6 | Yes | \$334.00 |
|  | Lateral File* <ul style="list-style-type: none"> • 31.97"W x 20"D x 30.21"H • Not on GSA Contract | Hansen Cherry Natural Cherry Mocha Cherry | PR76554 PR76354 PR76854 | 96 | 3.9 | Yes | \$485.00 |
|  | 5 Shelf Bookcase* <ul style="list-style-type: none"> • 29.76"W x 11.75"D x 66.34"H • Not on GSA Contract | Hansen Cherry Natural Cherry Mocha Cherry | PR76565 PR76365 PR76865 | 77 | 2.5 | Yes | \$334.00 |
|  | 32W Return* <ul style="list-style-type: none"> • 31.97"W x 20"D x 30.2"H • Not on GSA Contract | Hansen Cherry Natural Cherry Mocha Cherry | PR76515 PR76315 PR76815 | 38 | 1.7 | Yes | \$202.00 |
|  | Narrow Hutch* <ul style="list-style-type: none"> • 15.98"W x 14.17"D x 36.14"H • Not on GSA Contract | Hansen Cherry Natural Cherry Mocha Cherry | PR76505 PR76305 PR76805 | 43 | 1.6 | Yes | \$202.00 |

*Available as Drop Ship Only

Northfield

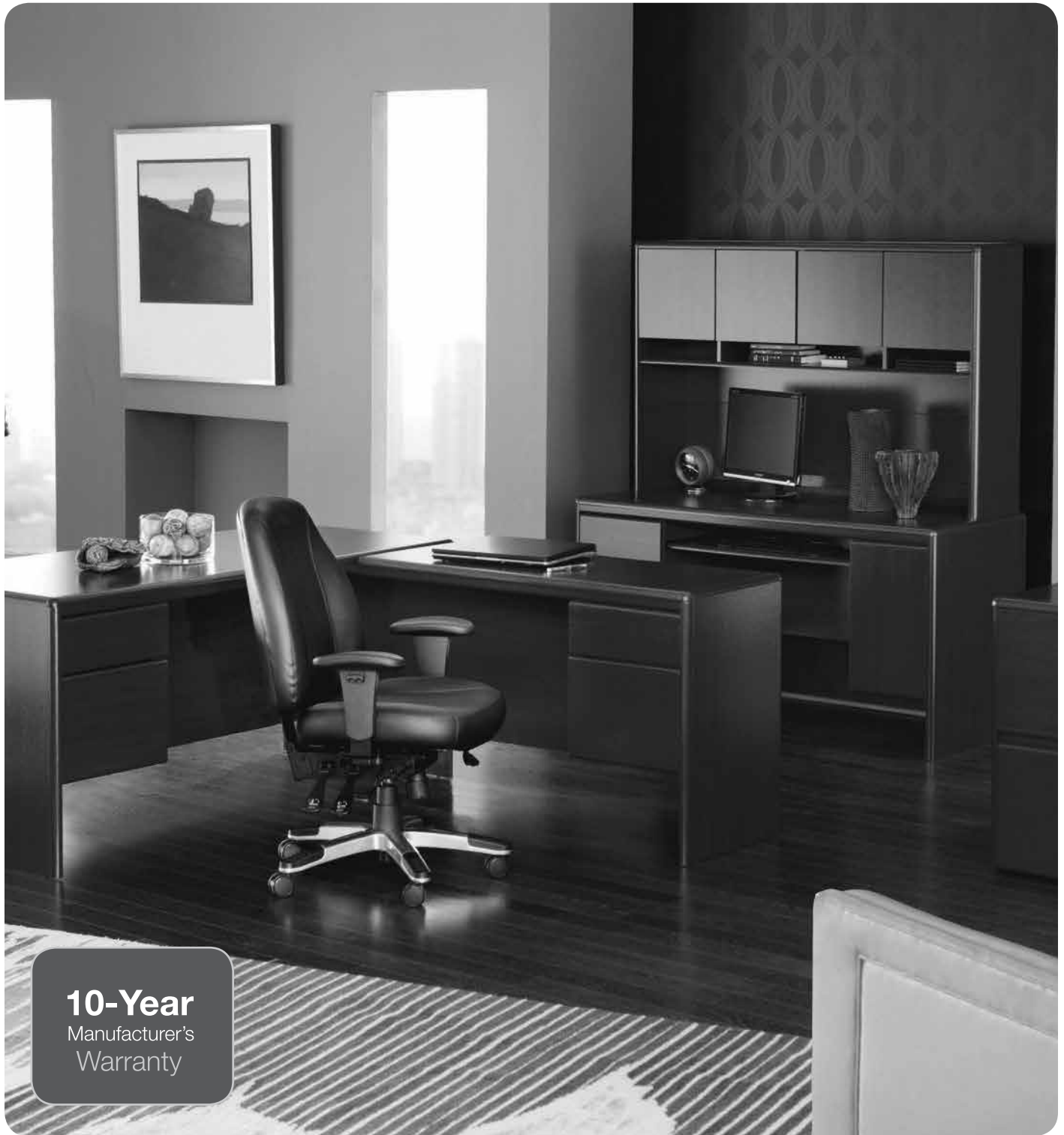

10-Year
Manufacturer's
Warranty

Northfield

- Durable melamine Work Surface
- Full-width keyboard shelf included (Harvest Cherry only)
- File drawer holds letter or legal-size files
- Wire management keeps cords and cables organized
- Euro-style hinges on Hutch doors
- Full-extension, ball-bearing slides on file drawers offer access to entire drawer contents
- Meets ANSI/BIFMA standards for safety and performance
- Commercial quality backed by 10-Year Warranty
- Certified to Level® 1 ANSI/BIFMA e3 Sustainable Standards

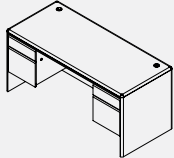
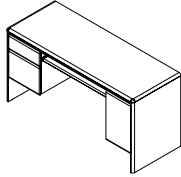
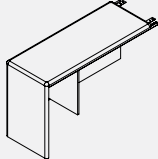
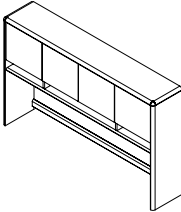
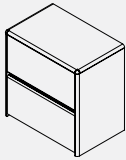
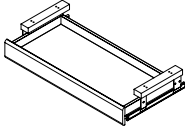
| | Description | Finish | SKU Number | Shpg Wt. (lbs) | Cube (ft.) | UPS/Fed Ex | List Price |
|---|---|------------------------------|-------------------------|---------------------------------------|--|----------------|------------|
|  | <p>Double Pedestal Desk*</p> <ul style="list-style-type: none"> Two box drawers for supplies and two file drawers that accommodate letter or legal-size files Box drawers utilize 3/4-extension, ball-bearing slides and file drawers utilize full-extension, ball-bearing slides 66.63"W x 29.38"D x 30.75"H Not on GSA Contract | Harvest Cherry Dakota Oak | EX17718K EX17518K | Box 1 82 Box 2 129 | Box 1 2.4 Box 2 5.7 | Yes | \$708.00 |
|  | <p>Credenza*</p> <ul style="list-style-type: none"> One box drawer for supplies and one file drawer that accommodates letter or legal-size files Box drawer utilizes 3/4-extension, ball-bearing slides and file drawer utilizes full-extension, ball-bearing slides Concealed vertical CPU or storage compartment utilizes Euro-style hinges 61.63"W x 23.38"D x 30.75"H Not on GSA Contract | Harvest Cherry Dakota Oak | EX17712 EX17512K | 146 Box 1 53 Box 2 93 | Box 1 5.2 Box 1 2.2 Box 2 3 | Yes Yes | \$557.00 |
|  | <p>Return*</p> <ul style="list-style-type: none"> Attaches to Double Pedestal Desk to form L shape by removing one Desk Pedestal and mounting it on the Return Non-handed: can mount on the left or right side of the Desk 49.63"W x 19.38"D x 30.75"H Not on GSA Contract | Harvest Cherry Dakota Oak | EX17710 EX17510 | 69 | 2.6 | Yes | \$268.00 |
|  | <p>Credenza Hutch*</p> <ul style="list-style-type: none"> Concealed overhead storage frees up Desk Surface Doors utilize Euro-style hinges Open compartments for easy access to work in progress Mounts to Credenza 59.38"W x 11.63"D x 36.63"H Not on GSA Contract | Harvest Cherry Dakota Oak | EX17713 EX17513 | 83 | 3 | Yes | \$379.00 |
|  | <p>Lateral File*</p> <ul style="list-style-type: none"> Drawers hold letter or legal-size files Full-extension, ball-bearing slides offer access to entire drawer contents 30.63"W x 19.63"D x 30.75"H Not on GSA Contract | Harvest Cherry Dakota Oak | EX17781 EX17581 | 105 | 4.1 | Yes | \$455.00 |
|  | <p>Pencil Drawer/Keyboard Tray *</p> <ul style="list-style-type: none"> Features flip-down drawer front and accommodates a full-width keyboard Mounts to Double Pedestal Desk or Return (sold separately) 30.59"W x 13.80"D x 2.01"H Not on GSA Contract | Harvest Cherry | EX17751 | | | | |

*Available as Drop Ship Only

Saratoga

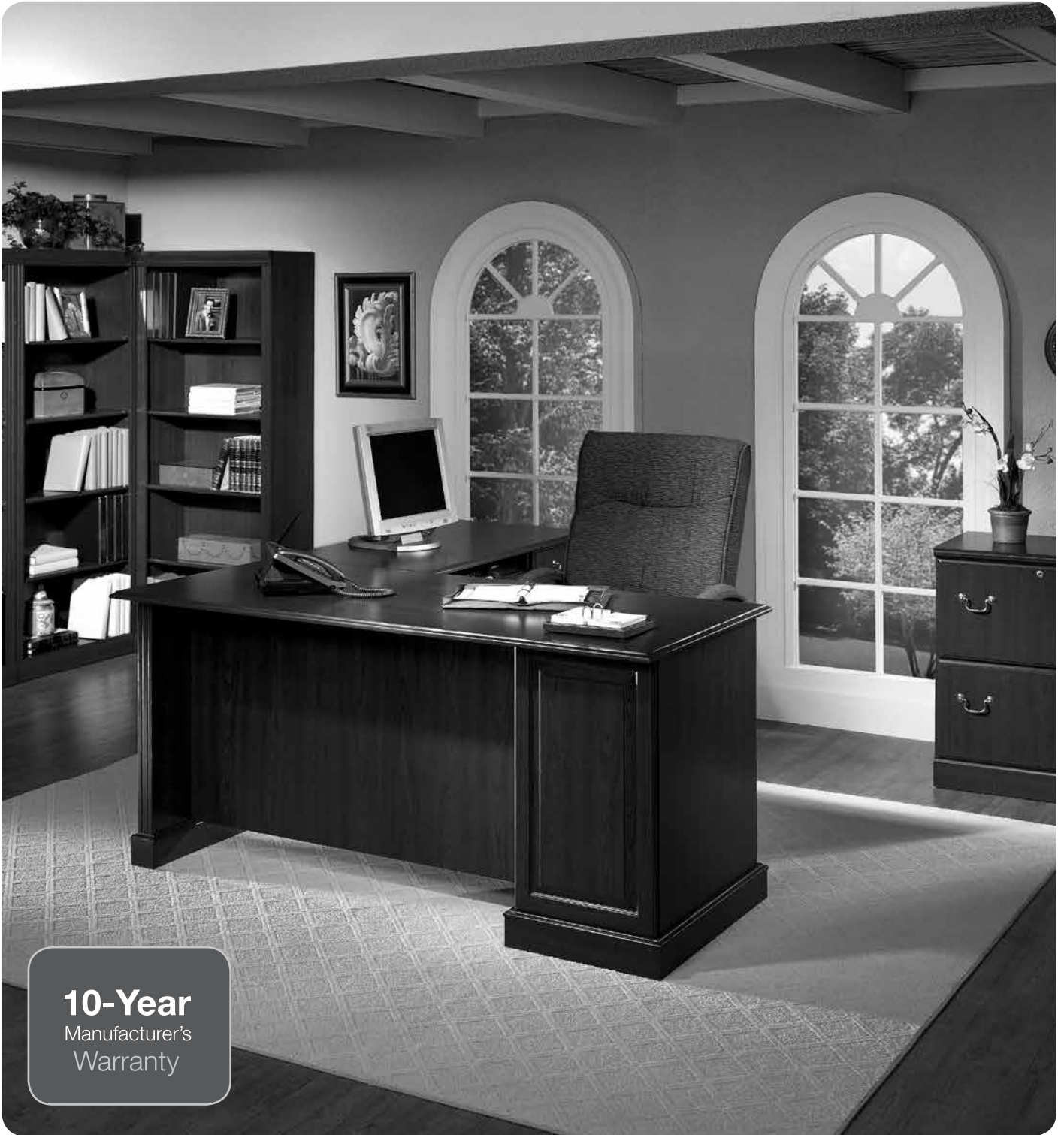

10-Year
Manufacturer's
Warranty

Saratoga

- Durable laminate Work Surfaces with black desktop insert on manager's desk
- Lockable file drawers for privacy
- File drawers glide on full-extension, ball-bearing slides
- Accepts letter, legal, or A4-size files
- Wide retracting Keyboard Shelf
- Adjustable shelves on Bookcase
- Meets ANSI/BIFMA standards for safety and performance
- Commercial quality backed by 10-Year Warranty

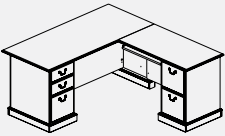
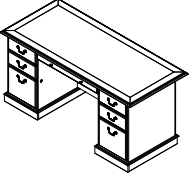
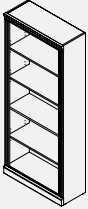
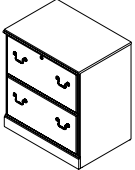
| | Description | Finish | SKU Number | Shpg Wt. (lbs) | Cube (ft.) | UPS/ Fed Ex | List Price |
|---|--|----------------|-------------|----------------------------------|----------------------------------|-------------|------------|
|  | <p>L-Desk*</p> <ul style="list-style-type: none"> • Right Pedestal features two file drawers; Left Pedestal contains two box drawers and one file drawer • Can be assembled either left or right handed • 66.13"W x 71.13"D x 30.75"H • Not on GSA Contract | Harvest Cherry | EX45670-03K | Box 1 119 Box 2 129 | Box 1 6 Box 2 7 | Yes | \$1,139.00 |
|  | <p>Manager's Desk*</p> <ul style="list-style-type: none"> • Black desktop insert adds durability and style • Center Pencil Drawer for miscellaneous office supplies • 66.13"W x 29.5"D x 30.75"H • Not on GSA Contract | Harvest Cherry | EX45666-03K | Box 1 88 Box 2 98 | Box 1 3.5 Box 2 5.1 | Yes | \$972.00 |
|  | <p>5 Shelf Bookcase*</p> <ul style="list-style-type: none"> • Two fixed shelves for stability • Three adjustable shelves for storage flexibility • 30"W x 12.63"D x 71.63"H • Not on GSA Contract | Harvest Cherry | W1615C-03 | 75 | 3.2 | Yes | \$363.00 |
|  | <p>Lateral File*</p> <ul style="list-style-type: none"> • Accepts letter, legal or A4 size files • Drawers utilize full-extension, ball-bearing slides • Lockable upper drawer for privacy • Matches desk height for additional Work Surface • 26.88"W x 19.38"D x 30.5"H • Not on GSA Contract | Harvest Cherry | EX45654-03 | 104 | 4 | Yes | \$538.00 |

*Available as Drop Ship Only

GSA Awarded Terms & Conditions

Bush Industries, Inc.

Federal Supply Service—
Authorized Federal Supply Schedule Price List
Online access to contract ordering information, terms and conditions, up-to-date pricing, and the option to create an electronic delivery order are available through GSA Advantage!, a menu-driven database system. The Internet address for GSA Advantage! is: GSAAdvantage.gov
Worldwide Federal Supply Schedule Contract for Schedule 71, Part 1- Office Furniture
FSC Groups 7105, 7110, 7125, 7195
Contract No. GS-28F-0040V

Contract Period: July 24, 2009, through July 23, 2019
Contractor: Bush Industries

Bush Industries
c/o Federal Government Sales
One Mason Drive, PO Box 460
Jamestown, NY 14702-0460
Phone: 1-888-339-2202
Fax: 1-716-665-1111
Email Address: GSAServices@BushIndustries.com
<http://www.bbffits.com/Markets/GSA.aspx>
Business Size: Small
For more information on ordering from Federal Supply Schedules click on the FSS Schedules button at fss.gsa.gov.

1. a. The following Special Item Numbers (SIN's) are hereby awarded as a part of this contract:
 - SIN 711-2 Worksurfaces, Workstations, Computer Furniture and Accessories
 - SIN 711-3 Filing and Storage Cabinets, Shelves, Mobile Carts, Dollies, Racks, and Accessories
 - SIN 711-11 Tables and Accessories
 - SIN 711-8 Executive Office Furniture
 - SIN 711-18 Multi Purpose Seating
 - SIN 711-19 Stacking Chairs
- b. N/A. For all pricing refer to: Schedule GS-28F-0040V at www.gsaadvantage.gov
- c. Hourly rates N/A
2. Maximum Order \$500,000 Net

3. Minimum Order \$1
4. Geographic coverage: Shipped to addresses with the contiguous US only, no shipments to PO boxes, APO/ FPO addresses, Alaska or Hawaii
5. Points of Production: Within United States
6. Discount: 58.21% from BBF (Bush Business Furniture) GSA Pricelist updated June 2015. All commercial product will be shipped with Prepaid Freight pricing for shipments to contiguous US destinations.
7. Quantity discounts per shipment/location:
\$25,001 - \$125,786 List 60.25%
\$125,787 - \$1,368,738 List 63.48%

Contact BBF GSA Support: 1-888-339-2202
for more information

8. Prompt Payment Terms: Net 30
9. a. Government purchase cards accepted at or below the micro-purchase threshold
- b. Government purchase cards are accepted above the micro-purchase threshold
10. Foreign items: BBF Federal Government office furniture schedule only offers items which are made in TAA-Compliant countries.
11. a. Delivery Time: 30 days ARO (Maximum 30 days—most orders ship within 3-5 days, assembled orders deliver within 20 days from shipment. Delivery times vary depending on base security clearance.)
- b. Expedited Delivery: Contact BBF GSA Support; 1-888-339-2202 for availability and expedited freight rate.
- c. Overnight and 2-day delivery: Contact BBF GSA Support; 1-888-339-2202 for availability and expedited freight rate.
- d. Urgent Requirements: Contact BBF GSA Support; 1-888-339-2202 with details.



Schedule

Contract GS-28F-0040V

12. a. FOB points: FOB Destination
 b. FOB Terms: The following FOB terms apply to all orders:
 - The above charges are limited to deliveries to a commercial delivery dock. If no dock is available or additional services are required, additional charges are applicable.
13. a. Ordering address: same as Contractor.
 b. Ordering Procedures: Orders may be placed via:
 - GSA Advantage! www.gsaadvantage.gov
 - Fax: 1-716-665-1111
 - Email: GSAServices@BushIndustries.com
 - U.S. Postal: Bush Industries
One Mason Drive
Jamestown, NY 14702
14. Payment address: same as Contractor.
15. a. Warranty: The following warranty applies as shown by product line:
 - 10-year limited warranty: Series A, Series C, Series C Elite, Aspen Conference Tables and Accessories
 - Limited lifetime warranty: Momentum, Milano2, Realize, Quantum and Synchronize Metal Filing
 - 5-year limited warranty; Height Adjustable Tables
Privacy Screens
 b. Cancellation Policy: No cost prior to production. After production has begun, only actual costs incurred that the contractor can demonstrate will be charged to the Government if the product cannot be sold in a reasonable length of time (6 months).
 c. Return Policy/Restocking Fee: The Government customer must obtain written authorization from Bush Industries prior to returning any products and they will also be required to pay all outbound/ in-bound freight charges. A restocking fee of 20% will apply to all returned products.
16. Export packing charges: N/A
17. Terms and conditions of Government purchase card: Government purchase card accepted for all orders
18. Terms and conditions of rental, maintenance, and repair: N/A
19. Terms and conditions of installation: call for details
20. Terms and conditions of repair parts: products are guaranteed to be free of defects for the warranty period (warranty period is based on brand – refer to above or warranty card in product carton). This warranty is expressly limited to replacement of furniture parts and components. For all issues related to post sale service such as parts replacement, warranty claims, assembly tips, defective product disposition, call Consumer Service at 800-950-4782. No credit will be issued for defective product without prior authorization.
 - a. Terms and conditions of any other services: call for details
21. List of service and distribution points: Erie, PA 16509 & McCarran, NV 89434
22. List of participating dealers: call for details
23. Preventive maintenance: N/A
24. a. Special attributes: Bush Industries' manufacturing facility is currently on course to meet BIFMA Level certification. Visit <http://www.bbffits.com/AboutBBF/SustainabilityMaterialRecovery.aspx> for more information regarding Bush Industries commitment to: CARB compliance, EPP Downstream Program (Composite Panel Association), Energy Consumption, Landfill Reduction, Corporate Recycling, and Sustainability.
 - b. Section 508 Compliance: N/A
25. DUNS number: 00211961
26. CCR Registration: Bush Industries is registered DUNS – 00211961 CAGE – 3CA68



One Mason Drive
PO BOX 460
Jamestown, NY 14702-0460
800.964.1638
Fax: 716.665.2074
www.bbffits.mobi

To reorder this catalog e-mail
literature@bushindustries.com
BBFPRICER09/16 Printed 9/16
Electronic Edition Updated 9/16



BUSH BUSINESS FURNITURE



BBF Seating Price List

Updated January 2016



Federal Supply Service- Authorized Federal Supply Schedule Price List On-line access to contract ordering information, terms and conditions, up-to date pricing, and the option to create an electronic delivery order are available through GSA Advantage!, a menu-driven database system.

The Internet address for GSA Advantage! is: GSAAvantage.gov • Worldwide Federal Supply Schedule Contract for Schedule 71, Part 1- Office Furniture
FSC Groups 7105, 7110, 7125, 7195 Contract No. GS-28F-0040V • Contract Period: July 24, 2009, through July 23, 2019

Contractor: Bush Industries Federal Government Sales • One Mason Drive, PO Box 460 • Jamestown, NY • 14702-0460 • Phone: 1-888-339-2202 • Fax: 1-716-665-1111

Email Address: GSAServices@BushIndustries.com • <http://www.bbffits.com/Markets/GSA.aspx>

Business Size: Small • For more information on ordering from Federal Supply Schedules click on the FSS Schedules button at fss.gsa.gov.

BBF seating fits your
style, your budget,
your business.



Table of Contents

Terms and Conditions..... 2
Condition of Sale 3
Care and Maintenance 3
Warranty..... 4
Fabric Code Reference 5
Chair by Use Guide 5
Control Selection Guide 6
Arm Selection Guide..... 7
GSA Terms and Conditions....28-29

Product Lines

Charge (Mid Back)8-9
Charge (High Back)10-11
Spur (Mid Back)12-13
Spur (High Back)14-15
Amp (Mid Back Mesh)16-17
Amp (Mid Back Upholstered)18-19
Pace (Low Back)20-21
Pace (Mid Back)22-23
Pace (High Back)24-25
Dash.....26-27



Terms and Conditions

Pricing

Prices shown are manufacturer's list price at time of printing. Prices are subject to change without notice. All prices shown are in US dollars. Freight surcharge - Dash:* \$15 (Net) per chair for all orders of 4 or less BBF Dash chairs.

Install 360 Pricing

Install 360 Service: Install 360 pricing includes furniture delivery, assembly, installation, final adjustments to ensure optimal product performance, dusting, leveling and package removal – all in a single visit. Pricing for Install 360 is individually quoted, please call 800.964.1638 for a price quote.

Pre-Order Support

Space-Planning:

Bush offers a free space-planning service. Install 360 orders of more than 25 pieces require a completed space plan before an order can be processed. Contact Bush Space-Planning at 800-964-1638 or email spaceplanning@bushindustries.com for assistance.

Order Processing

Order Receipt:

Order is transmitted to Bush in writing (preferably electronically) by Dealer/Retailer. Dealer is responsible for providing correct model numbers by finish, requested delivery method, pricing and ship-to information when placing an order. Orders can be accepted electronically through EDI, or CSV flat file (Excel), or you can email your Account Representative a pdf file or fax orders to 716-665-1111. New customers must also submit a credit application and signed Bush Dealer Agreement before an order can be accepted.

- Next Day shipping terms apply to orders received electronically (EDI or CSV Flat File.)
- Additional processing time may be required for orders not received electronically.
- Orders received after 12pm (ET) are considered received next business day.

Customer Service/Sales Support:

Please call 800.964.1638 for assistance with questions regarding order processing, product availability and general product information. Office hours are Monday-Friday, 8 am–5 pm ET excluding all major holidays.

Shipping:

Most STANDARD orders deliver within 3–5 business days, from receipt of order. (Remote locations may take longer).

Most Install 360 orders deliver within 10 business days. Orders are invoiced at the time of shipment; See Bush Dealer Agreement for complete terms of sale.

Post-Sale Support

Return Policy:

A return authorization is required - Contact Bush Consumer Service Department at 800-950-4782 or email consumerservice@bushindustries.com to get authorization. Bush cannot accept returns or issue credit without prior authorization. See Bush Dealer Agreement for complete terms and conditions. Due to immediate production scheduling, orders which have entered any stage of production cannot be cancelled. All BBF Seating chairs are made to order, custom designed chairs and are not "off the shelf". Requests for cancellation are not accepted until confirmed by Bush Industries. Product may only be returned after receiving a Return Authorization number from Bush Industries. Returns are subject to a 50% restocking charge, which includes inbound & outbound freight. Unauthorized returns will be refused.

Warranty Policy:

For all issues related to post-sale service such as parts replacement, warranty claims and assembly tips, please call Consumer Service at 800-950-4782, or e-mail consumerservice@bushindustries.com Monday-Friday 8:30 am–7:30 pm ET.

Condition of Sale

Freight Damage or Shortage

Before accepting a shipment from the carrier, check the boxes for visible damages. If a shortage or damage occurs during transit, it should be noted on the freight bill of lading at the time of delivery, and a claim filed within 7 days from receipt of product. If concealed damage is discovered after delivery, request inspection from the delivering carrier IMMEDIATELY and save all packing materials until inspection is made. Contact Bush consumer service as soon as possible to report damage or shortage.

Bush Industries will not be liable for any installation costs that result from freight damage, not associated with an Install 360 order.

Product Design

Bush Industries reserves the right to make alterations in design and construction or to discontinue products without prior notice.

Care and Maintenance Instructions

- Insure the gas cylinder is inserted into the control firmly. Improper connection may cause wobbling.
- Choose correct casters for different floor surfaces. We suggest choosing hard floor casters for hard or concrete surfaces.
- Do not sit on arms, backrest or any part of the chair except the seat.
- Improper sitting may cause an imbalance, resulting in bodily injury.
- Do not use chair as stepladder. Use this chair only for seating one person at a time.
- To avoid chair collapse do not remove knobs or screws.
- Do not use chair unless all bolts, screws and knobs are tightly in place.
- Properly dispose of packing materials. Do not use plastic as head covering. It may cause suffocation.
- If any parts are missing, broken, damaged or worn, do not use the chair until repairs are made using factory-authorized parts.
- Do not attempt to make any alterations to chair.
- Do not use chair on uneven floor surfaces. Always use the chair on flat surfaces to prevent accidents.
- Chairs are designed for normal commercial use by persons 250 lbs. or less, single shift use 8 hours per day 5 days a week.
- Do not drape coats or sweaters on back of chairs with casters. Hanging fabric may suddenly stop casters from rolling.
- Do not use excessive speed when moving the chair with casters while seated.

LIMITED LIFETIME WARRANTY – BBF Seating: Charge, Spur, Amp, Pace, Dash

Limited Lifetime Warranty to the original end user; Bush will repair or replace, at its option, without charge to the original purchaser only, defective structural and mechanical parts. This warranty is for single shift, standard commercial usage, defined as a standard eight hour work day, five days a week, when the product is used by a person weighing less than 250 pounds.

Upholstery fabric, foam and mesh is warranted against wear through and deterioration during normal usage for a period of five (5) years. However, Bush does not warrant leather against routine scratching and scuffing, as all leather is subject to minor blemishes during use. Due to natural variations in material, furniture containing leather is sold subject to normal variation and/or irregularities of color, texture, and grain.

Under no circumstance, including but not limited to breach of contract, breach of warranty or negligence, shall Bush or its suppliers be liable for lost profits, loss of goodwill, stored data, general, special, consequential or exemplary damages, even if Bush or its suppliers had notice of these damages or they were foreseeable. Bush and its suppliers shall not be responsible for verifying dealer's or customer's description of needs, data, or the fitness for a particular purpose of goods. Bush's and its suppliers' liability in all cases shall be limited to repair or replacement of the defective parts, or the purchase price of the product. Damages resulting from misuse, abuse, alteration, negligence, or accidents are not covered under this warranty.

EXCEPT AS OTHERWISE PROVIDED, BUSH MAKES NO OTHER WARRANTIES, EXPRESSED OR IMPLIED, INCLUDING BUT NOT LIMITED TO THE WARRANTIES OF MERCHANTABILITY AND FITNESS FOR A PARTICULAR PURPOSE.

If you purchased the seating product for your home or for your own personal or family use, Bush's warranty gives you specific legal rights and you may have other rights, which vary from state to state. As a consumer purchaser, the complete exclusion of implied warranties does not apply to you; however, to the extent allowed by applicable state law, the implied warranties are limited to the applicable term of the warranty. Some states do not allow the exclusion or limitation of incidental or consequential damages, so the above exclusion or limitation may not apply to you.

Should parts fail during normal use within the applicable warranty period, you must first provide Bush with a description of the failure and proof of purchase and, if necessary, you may need to return the defective part freight or other shipping charges prepaid to a location designated by Bush for inspection, repair and/or replacement, together with a copy of the original sales receipt. Labor and installation service is not covered under warranty.

After the part in question has been inspected, Bush will repair or replace, at its option, any defective part at no charge to the original purchaser and return defective item thereafter. This warranty does not apply to product or parts of product that have been subjected to misuse or abuse, accident, alteration, or which have been damaged in transit. You agree to indemnify and hold harmless Bush, its suppliers, and their respective officers, directors, shareholders, employees, and agents from any actions, claims, demands, damages, liabilities, costs, and strict liability in tort or contract, or any other legal theory arising out of the misuse or abuse, alteration, or damage in transit of the product.

Fabric Code Guide

Chime

- Black 101
- Gray 102
- Dark Blue 104
- Burgundy 106

Pulse

- Champagne 111
- Fern 112
- Lead 113
- Plum 114
- Peacock 115
- Coal 116

Jibe

- Champagne 131
- Green 132
- Gray 133
- Cherry 134
- Navy 135
- Black 136

Calypso

- Camel 141
- Latte 142
- Slate 143
- Flame 144
- Ocean 145
- Nightfall 146

Hustle

- Honey 151
- Wasabi 152
- Bark 153
- Ruby 154
- Lake 155
- Charcoal 156

T01- Airmesh Fabric (Amp only)

Leather Code Guide

* Leather on seat and back and simulated leather on balance of chair

L3

- Black L31
- Brown L32

L4

- Sandstone L40
- Mocha L41
- Taupe L42
- Saddle L43
- Gray L44
- Navy L45
- White L48

Chair by Use Guide

| | Executive | Conference | Management | Task | Guest |
|--------|-----------|------------|------------|------|-------|
| Charge | ● | ● | ● | | |
| Spur | ● | ● | ● | ● | |
| Amp | | ● | ● | ● | |
| Pace | ● | ● | ● | ● | |
| Dash | | | | | ● |

Control Selection Guide

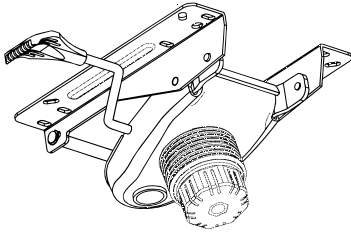

(K) Knee-Tilt

Ultimate seating comfort suited for the executive or manager. Allows for a full range of movement with a reduced rise of front seat edge. 5 position multi-lock with built-in safety return feature.

Models: Charge

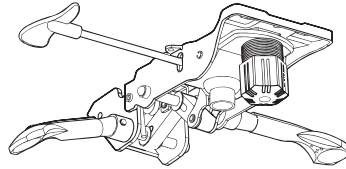

(R) Rocking

For managerial and task applications. Similar to a swivel-tilt control with the added comfort of infinite back-angle adjustment and infinite tilt lock. Features 3" Cold-Rolled Steel J-Bar to connect seat and back.

Models: Spur, Pace

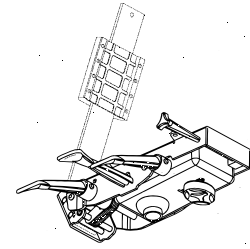

(M) Multi-Function

For the highest level of ergonomic needs, suited for multi-task functions. Seat pivots from 0 to 6 degrees forward. 3.00" wide Cold Rolled Steel J-Bar to connect seat and back.

Models: Spur, Amp, Pace

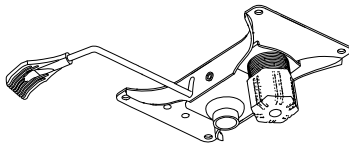

(S) Swivel Tilt

Use for a variety of general office seating, including private office and conference room seating. Control locks upright for tasking.

Models: Charge

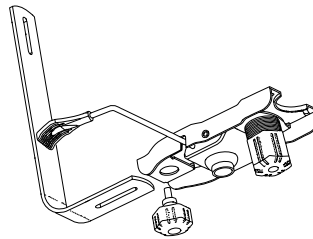

(L) Swivel Tilt

Use for a variety of general office seating, including private office and conference room seating. Similar function to the (S), however utilizing a 2.25" Cold-Rolled Steel J-Bar to connect seat and back. Control locks upright for tasking.

Models: Spur, Pace

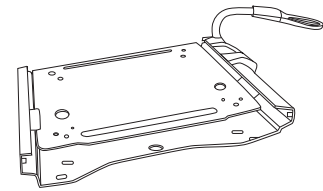

(C) Seat Slider

Side paddle activated Seat Slider has 6 positions and slides 2.5". Only available with (S), (R), (M) and (Y).

Models: Spur, Pace

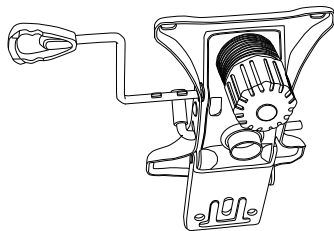

(Y) Simple Synchro Tilt

Recline with a synchro back and seat movement. Reduced rise of front seat edge. Back may free float or be locked upright. Comparable to swivel tilt control but with asynchronous movement.

Models: Amp

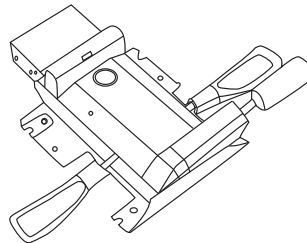

(V) Synchro Tilt

Recline with a synchro back and seat movement featuring a 2:1 back to seat tilt ratio. Reduced rise of front seat edge. 5 position multi-lock with built-in safety return feature.

Models: Spur, Pace

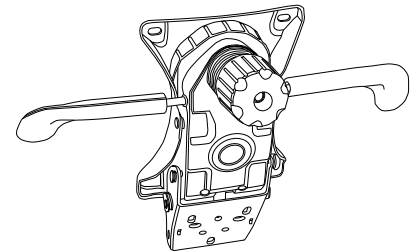

(W) Synchro Tilt

Recline with a synchro back and seat movement featuring a 2:1 back to seat tilt ratio. Reduced rise of front seat edge. 5 position multi-lock with built-in safety return feature.

Models: Amp

Arm Selection Guide

Fixed



(X) Armless

Armless chairs offer increased mobility and are useful for applications and users that do not require elbow support while working

Models: All



(B) Loop Arm

Soft Touch Loop Arm

Models: Pace



(D) Soft Touch "C" Shaped Arm

Sleek executive style Cantilever arm made with durable polyurethane

Models: Charge, Pace



(N) "C" Arm

Soft Touch Cantilever Arm.

Models: Spur



(U) Polished Aluminum "C" Arm

This fixed Cantilever arm offers a smooth polished aluminum surface in an attractive cantilever style design with black cap.

Models: Spur

Adjustable



(C) Adjustable Arm

Features height adjustment via simple trigger mechanism under arm pad.

Models: Amp



(E) Soft Touch Adjustable Arm

Offers a soft touch poly-urethane pad with 3" height adjustment. The arm pad features diamond padded anti-skid surface.

Models: Pace



(F) Soft Touch Multi-Adjustable Arm

Identical to the (E) arm but offers the added feature of 4" arm width adjustment activated via knob under seat.

Models: Pace

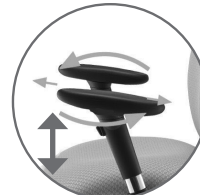

(T) Soft Touch Adjustable Pivot/Swivel Arm

Offers advanced features with soft touch poly-urethane pads. Features locking 3.5" height adjustment range, swivel pad and adjustable arm pad position - slides forward and back.

Models: Spur, Pace

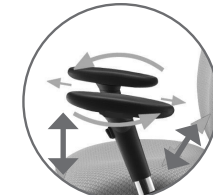

(H) Soft Touch Multi-Adjustable Pivot/Swivel Arm

Identical to the (T) arm but offers the added feature of 4" arm width adjustment activated via knob under seat.

Models: Spur, Pace



(P) Soft Touch Pad w/ 3.5" Height Adjustable Arm

This height adjustable black arm features push-button height adjustment with a range of 3.5" and matching black powder-coated base

Models: Spur, Amp



(Q) Soft Touch Pad w/ 3.5" Height & 4" Width Adjustable Arm

Identical to the (P) arm but offers the added feature of 4" arm width adjustment activated via knob under seat.

Models: Spur, Amp



CHARGE (Mid Back) *SIN: 711 18*

This handsomely designed executive chair has a refined and stately presence while maintaining a comfortable, inviting look. Charge is equally at home in a private office, den or conference room.

(CM) Mid Back

Control Model

Arm Options

L3/L4 Leather*

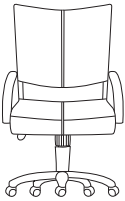

(S) Swivel Tilt Control

Use for a variety of general office seating, including private office and conference room seating.

(X) Armless
(D) "C" Arm

\$633
\$748

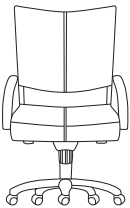

(K) Knee Tilt Control

Ultimate seating comfort suited for the executive or manager. Allows for a full range of movement with a reduced rise of seat front edge.

(X) Armless
(D) "C" Arm

\$691
\$806

Creating CHARGE (Mid Back) Model

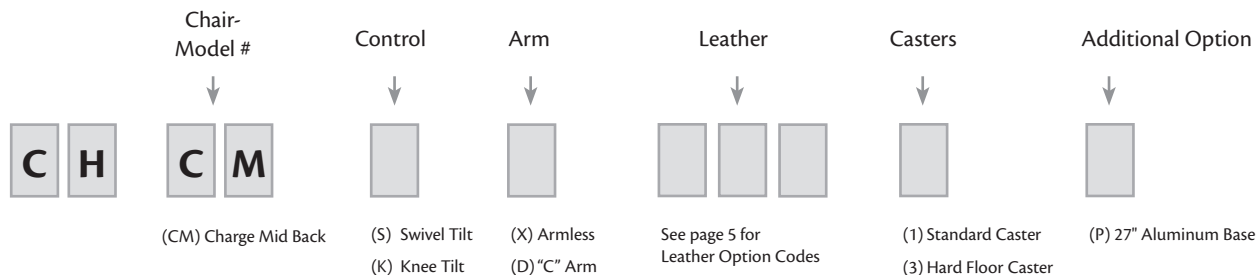

| Key | |
|-----------------|-----------------|
| W = Width | BW= Back Width |
| D= Depth | BH= Back Height |
| H= Height | |
| SW= Seat Width | WT = Weight |
| SD= Seat Depth | |
| SH= Seat Height | |

| Mechanical Functions | Dimensions | |
|--|---|--|
| <ul style="list-style-type: none"> • 360 Degree Swivel • Pneumatic Seat Height Adjustment • Tilt Tension Control • Seat and Back Tilt as a Unit • Upright Position Tilt Lock | W: 25.8 D: 24.0 H: 39.0-44.0 SW: 21.0 SD: 20.5 SH: 16.5-21.5 | BW: 22.0 BH: 21.0 WT: 60.4 lbs. |
| <ul style="list-style-type: none"> • 360 Degree Swivel • Pneumatic Seat Height Adjustment • Tilt Tension Control • Seat and Back Tilt as a Unit • 5 Position Tilt Lock • Anti-kick Safety Release Feature • Reduced Rise of Seat Front Edge | W: 25.8 D: 24.0 H: 39.0-44.0 SW: 21.0 SD: 20.5 SH: 16.5-19.5 | BW: 22.0 BH: 21.0 WT: 60.4 lbs. |

* Leather on seat and back and simulated leather on balance of chair

Arm Options

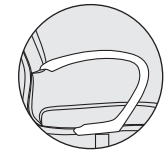

(D) Black Soft Touch C-Shape Arm

Casters

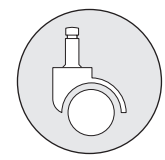

(1) Standard Caster

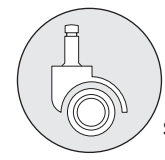

(3) Hard Floor Casters (5 per set) \$ 35

Additional Options

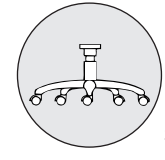



(P) 27" Polished Aluminum Base \$ 105



CHARGE (High Back) *SIN: 711 18*

This handsomely designed executive chair has a refined and stately presence while maintaining a comfortable, inviting look. Charge is equally at home in a private office, den or conference room.

| (CH) High Back | Control Model | Arm Options | L3/L4 Leather* |
|--|--|---------------------------------------|---------------------------|
|  | <p>(S) Swivel Tilt Control</p> <p>Use for a variety of general office seating, including private office and conference room seating.</p> | <p>(X) Armless</p> <p>(D) "C" Arm</p> | <p>\$696</p> <p>\$811</p> |
|  | <p>(K) Knee Tilt Control</p> <p>Ultimate seating comfort suited for the executive or manager. Allows for a full range of movement with a reduced rise of seat front edge.</p> | <p>(X) Armless</p> <p>(D) "C" Arm</p> | <p>\$754</p> <p>\$869</p> |

Creating CHARGE (High Back) Model

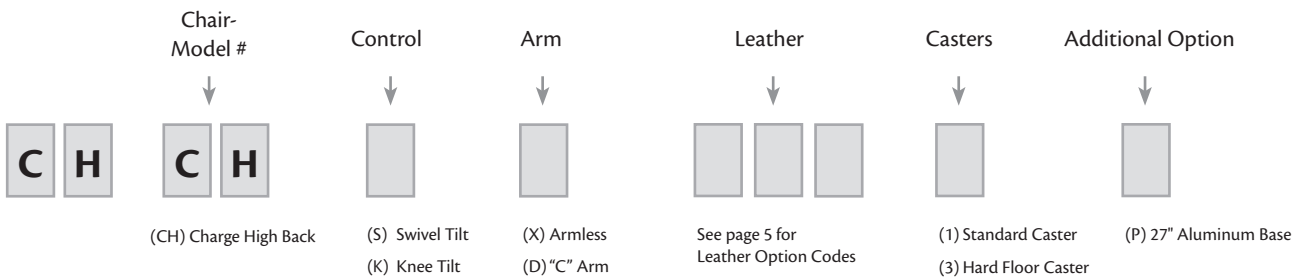

Key

| | |
|-----------------|-----------------|
| W = Width | BW= Back Width |
| D= Depth | BH= Back Height |
| H= Height | WT = Weight |
| SW= Seat Width | |
| SD= Seat Depth | |
| SH= Seat Height | |

Mechanical Functions

- 360 Degree Swivel
- Pneumatic Seat Height Adjustment
- Tilt Tension Control
- Seat and Back Tilt as a Unit
- Upright Position Tilt Lock

Dimensions

| | |
|----------------------|----------------------|
| W: 25.8 | BW: 22.0 |
| D: 24.0 | BH: 25.0 |
| H: 47.0-51.0 | |
| SW: 20.5 | |
| SD: 20.5 | WT: 64.0 lbs. |
| SH: 16.5-21.5 | |

- 360 Degree Swivel
- Pneumatic Seat Height Adjustment
- Tilt Tension Control
- Seat and Back Tilt as a Unit
- 5 Position Tilt Lock
- Anti-kick Safety Release Feature
- Reduced Rise of Seat Front Edge

| | |
|----------------------|----------------------|
| W: 25.8 | BW: 22.0 |
| D: 24.0 | BH: 25.0 |
| H: 46.0-51.0 | |
| SW: 20.5 | |
| SD: 20.5 | WT: 64.0 lbs. |
| SH: 16.5-21.5 | |

* Leather on seat and back and simulated leather on balance of chair

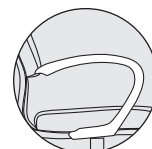
Arm Options

(D) Black Soft Touch C-Shape Arm

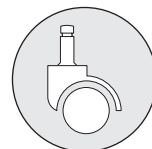
Casters

(1) Standard Caster

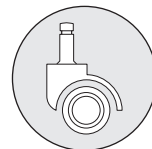

(3) Hard Floor Casters
(5 per set)

\$ 35

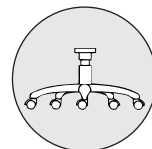
Additional Options







(P) 27" Polished Aluminum Base

\$ 105

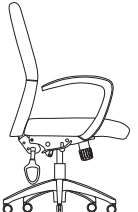
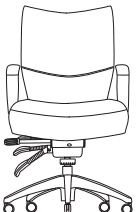
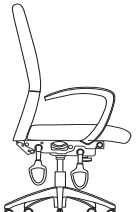

SPUR (Mid-Back) SIN: 711 18

It's sophisticated, stylish look and dynamic, versatile controls are the catalyst for action! Spur is cool, calm and collaborative.

| (SM) Mid Back | Control Model | Arm Options | Fabric | L3/L4 Leather* |
|---|--|--|---|---|
|   | (L) Swivel Tilt Control Use for a variety of general office seating, including private office and conference room seating. | (X) Armless (N) Cantilever Arm (U) Polished Alum. Cantilever Arm (P) STP Height Adj. (Q) STP Height/Width Adj. (T) STP Adj. Pivot/Swivel Arm (H) STP Multi Adj. Pivot/Swivel Arm | \$564 \$662 \$794 \$662 \$685 \$714 \$737 | \$794 \$892 \$1,024 \$892 \$915 \$944 \$967 |
|   | (R) Rocking Control For managerial and task applications. Similar to a swivel tilt control, with the added comfort of infinite back angle and tilt adjustment. | (X) Armless (N) Cantilever Arm (U) Polished Alum. Cantilever Arm (P) STP Height Adj. (Q) STP Height/Width Adj. (T) STP Adj. Pivot/Swivel Arm (H) STP Multi Adj. Pivot/Swivel Arm | \$622 \$720 \$852 \$720 \$743 \$772 \$795 | \$852 \$950 \$1,082 \$950 \$973 \$1,002 \$1,025 |
|   | (M) Multi-Function Control Fully articulating seat and back for the highest level of ergonomic needs. Control allows user to dial in forward seat pivot from 0 to 6 degrees. | (X) Armless (N) Cantilever Arm (U) Polished Alum. Cantilever Arm (P) STP Height Adj. (Q) STP Height/Width Adj. (T) STP Adj. Pivot/Swivel Arm (H) STP Multi Adj. Pivot/Swivel Arm | \$679 \$777 \$909 \$777 \$800 \$829 \$852 | \$909 \$1,007 \$1,139 \$1,007 \$1,030 \$1,059 \$1,082 |
|   | (V) Synchro-Tilt Control Use for a variety of general office seating, including private office and conference room seating. | (X) Armless (N) Cantilever Arm (U) Polished Alum. Cantilever Arm (P) STP Height Adj. (Q) STP Height/Width Adj. (T) STP Adj. Pivot/Swivel Arm (H) STP Multi Adj. Pivot/Swivel Arm | \$656 \$754 \$886 \$754 \$777 \$806 \$829 | \$886 \$984 \$1,116 \$984 \$1,007 \$1,036 \$1,059 |

Creating SPUR (Mid Back) Model

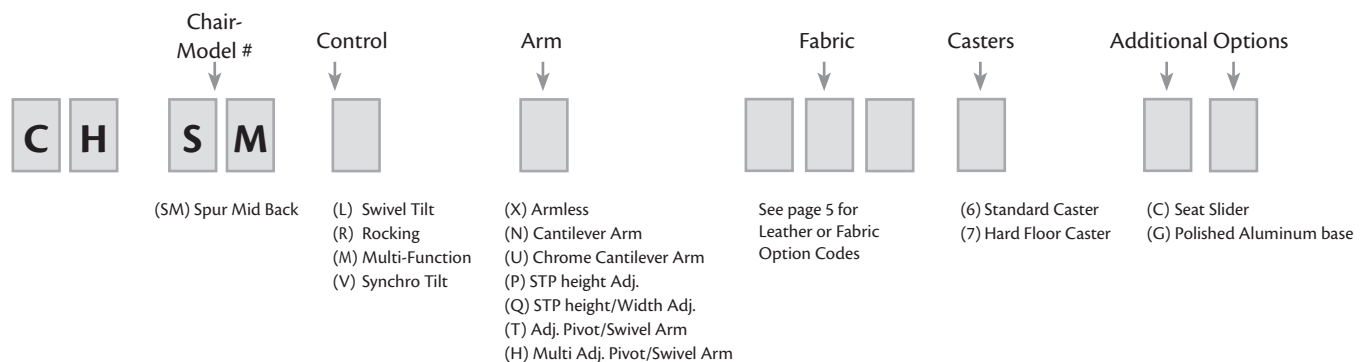

| Key | |
|-----------------|-----------------|
| W = Width | BW= Back Width |
| D= Depth | BH= Back Height |
| H= Height | WT = Weight |
| SW= Seat Width | |
| SD= Seat Depth | |
| SH= Seat Height | |

| Mechanical Functions | Dimensions | |
|--|---|--|
| <ul style="list-style-type: none"> • 360 Degree Swivel • Pneumatic Seat Height Adjustment • Tilt Tension Control • Seat and Back Tilt as a Unit • Upright Position Tilt Lock • Back Depth Adjustment | W: 24.5 D: 27.5 H: 37.0-42.0 SW: 20.0 SD: 19.0 SH: 16.5-21.5 | BW: 20.0 BH: 23.0 WT: 41.0 lbs W/ARMS: 46.7 lbs |
| <ul style="list-style-type: none"> • 360 Degree Swivel • Tilt Tension Control • Pneumatic Seat Height Adjustment • Infinite Seat Tilt Position Lock • Infinite Back Angle Adjustment • Seat and Back Tilt as a Unit | W: 24.5 D: 27.5 H: 37.0-42.0 SW: 20.0 SD: 19.0 SH: 16.5-21.5 | BW: 20.0 BH: 23.0 WT: 41.0 lbs W/ARMS: 46.7 lbs |
| <ul style="list-style-type: none"> • 360 Degree Swivel • Pneumatic Seat Height Adjustment • Tilt Tension Control • Seat and Back Tilt as a Unit • Infinite Tilt Position Lock • Infinite Back Angle w/ Free Float • Seat Pivots From 0 to 6 Degrees Forward | W: 24.5 D: 27.5 H: 37.0-42.0 SW: 20.0 SD: 19.0 SH: 16.5-21.5 | BW: 20.0 BH: 23.0 WT: 41.0 lbs W/ARMS: 46.7 lbs |
| <ul style="list-style-type: none"> • 360 Degree Swivel • Pneumatic Seat Height Adjustment • Tilt Tension Control • Back and Seat Tilt in 2:1 ratio • 5 Point Tilt Position Lock • Anti-Launch Tilt Release | W: 24.5 D: 27.5 H: 37.0-42.0 SW: 20.0 SD: 19.0 SH: 16.5-21.5 | BW: 20.0 BH: 23.0 WT: 41.0 lbs W/ARMS: 46.7 lbs |

* All leather seating is upholstered with leather on the seating surface and vinyl on the back.

Arm Options



(N) Black Soft Touch Cantilever Style 'C' Arm

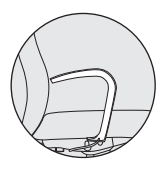

(U) Polished Aluminum Cantilever Style 'C' Arm w/ Black Arm Pad

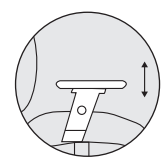

(P) Soft Touch Pad w/ 3.5" Height Adjustable Arm

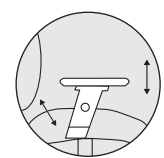

(Q) Soft Touch Pad w/ 3.5" Height & 4" Width Adjustable Arm

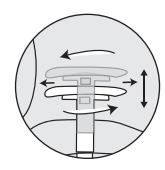

(T) Soft Touch Adjustable Pivot/Swivel Arm

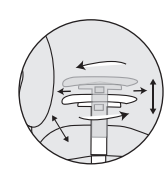

(H) Soft Touch Multi-Adjust Pivot/Swivel Arm

Casters

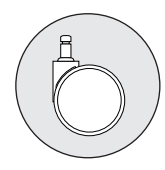

(6) Standard Caster

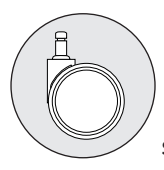

(7) Hard Floor Casters, Large (5 per set) **\$ 35**

Additional Options

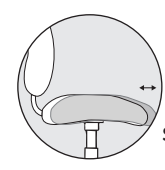

(C) Seat Slider 2.5" Side Paddle Activated **\$ 70**

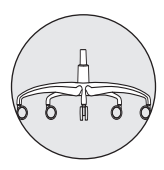



(G) 26" Polished Aluminum Base including matching casters and cylinder with polished aluminum accents **\$ 115**

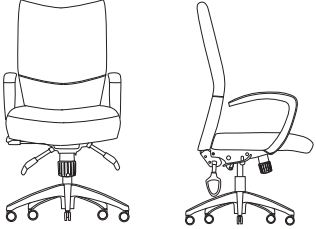
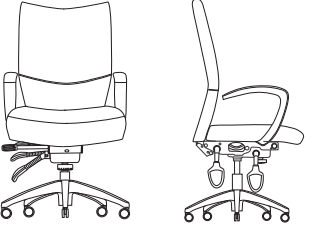

SPUR (High Back) SIN: 711 18

It's sophisticated, stylish look and dynamic, versatile controls are the catalyst for action! Spur is cool, calm and collaborative.

| (SH) High Back | Control Model | Arm Options | Fabric | L3/L4 Leather* |
|---|--|--|---|---|
|  | (L) Swivel Tilt Control Use for a variety of general office seating, including private office and conference room seating. | (X) Armless (N) Cantilever Arm (U) Polished Alum. Cantilever Arm (P) STP Height Adj. (Q) STP Height/Width Adj. (T) STP Adj. Pivot/Swivel Arm (H) STP Multi Adj. Pivot/Swivel Arm | \$656 \$754 \$886 \$754 \$777 \$806 \$829 | \$903 \$1,001 \$1,133 \$1,001 \$1,024 \$1,053 \$1,076 |
|  | (R) Rocking Control For managerial and task applications. Similar to a swivel tilt control, with the added comfort of infinite back angle and tilt | (X) Armless (N) Cantilever Arm (U) Polished Alum. Cantilever Arm (P) STP Height Adj. (Q) STP Height/Width Adj. (T) STP Adj. Pivot/Swivel Arm (H) STP Multi Adj. Pivot/Swivel Arm | \$714 \$812 \$944 \$812 \$835 \$864 \$887 | \$961 \$1,059 \$1,191 \$1,059 \$1,082 \$1,111 \$1,134 |
|  | (M) Multi-Function Control Fully articulating seat and back for the highest level of ergonomic needs. Control allows user to dial in forward seat pivot from 0 to 6 degrees. | (X) Armless (N) Cantilever Arm (U) Polished Alum. Cantilever Arm (P) STP Height Adj. (Q) STP Height/Width Adj. (T) STP Adj. Pivot/Swivel Arm (H) STP Multi Adj. Pivot/Swivel Arm | \$771 \$869 \$1,001 \$869 \$892 \$921 \$944 | \$1,018 \$1,116 \$1,248 \$1,116 \$1,139 \$1,168 \$1,191 |
|  | (V) Synchro-Tilt Control Use for a variety of general office seating, including private office and conference room seating. | (X) Armless (N) Cantilever Arm (U) Polished Alum. Cantilever Arm (P) STP Height Adj. (Q) STP Height/Width Adj. (T) STP Adj. Pivot/Swivel Arm (H) STP Multi Adj. Pivot/Swivel Arm | \$748 \$846 \$978 \$846 \$869 \$898 \$921 | \$995 \$1,093 \$1,225 \$1,093 \$1,116 \$1,145 \$1,168 |

Creating SPUR (High Back) Model

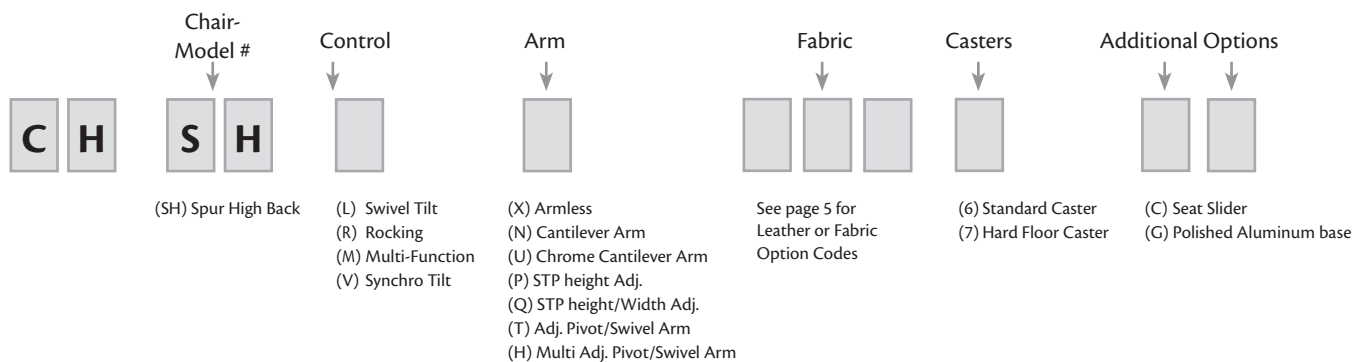

| Key | |
|-----------------|-----------------|
| W = Width | BW= Back Width |
| D= Depth | BH= Back Height |
| H= Height | WT = Weight |
| SW= Seat Width | |
| SD= Seat Depth | |
| SH= Seat Height | |

| Mechanical Functions | Dimensions | |
|---|---|--|
| <ul style="list-style-type: none"> • 360 Degree Swivel • Pneumatic Seat Height Adjustment • Tilt Tension Control • Seat and Back Tilt as a Unit • Upright Position Tilt Lock • Back Depth Adjustment | W: 24.5 D: 27.5 H: 42.0-47.0 SW: 20.0 SD: 19.0 SH: 16.5-21.5 | BW: 20.0 BH: 28.0 WT: 43.0 lbs W/ARMS: 48.7 lbs |
| <ul style="list-style-type: none"> • 360 Degree Swivel • Pneumatic Seat Height Adjustment • Tilt Tension Control • Infinite Seat Tilt Position Lock • Infinite Back Angle Adjustment • Seat and Back Tilt as a Unit | W: 24.5 D: 27.5 H: 42.0-47.0 SW: 20.0 SD: 19.0 SH: 16.5-21.5 | BW: 20.0 BH: 28.0 WT: 43.0 lbs W/ARMS: 48.7 lbs |
| <ul style="list-style-type: none"> • 360 Degree Swivel • Pneumatic Seat Height Adjustment • Tilt Tension Control • Seat and Back Tilt as a Unit • Infinite Tilt Position Lock • Infinite Back Angle w/ Free Float • Seat Pivots From 0 to 6 Degree Forward | W: 24.5 D: 27.5 H: 42.0-47.0 SW: 20.0 SD: 19.0 SH: 16.5-21.5 | BW: 20.0 BH: 28.0 WT: 43.0 lbs W/ARMS: 48.7 lbs |
| <ul style="list-style-type: none"> • 360 Degree Swivel • Pneumatic Seat Height Adjustment • Tilt Tension Control • Back and Seat Tilt in 2:1 ratio • 5 Point Tilt Position Lock • Anti-Launch Tilt Release | W: 24.5 D: 27.5 H: 42.0-47.0 SW: 20.0 SD: 19.0 SH: 16.5-21.5 | BW: 20.0 BH: 28.0 WT: 43.0 lbs W/ARMS: 48.7 lbs |

* All leather seating is upholstered with leather on the seating surface and vinyl on the back.

Arm Options



(N) Black Soft Touch Cantilever Style 'C' Arm



(U) Polished Aluminum Cantilever Style 'C' Arm w/ Black Arm Pad

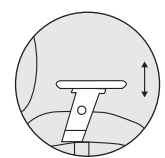

(P) Soft Touch Pad w/ 3.5" Height Adjustable Arm

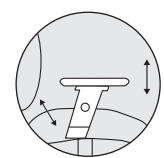

(Q) Soft Touch Pad w/ 3.5" Height & 4" Width Adjustable Arm

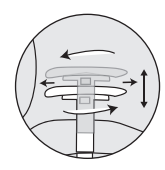

(T) Soft Touch Adjustable Pivot/Swivel Arm

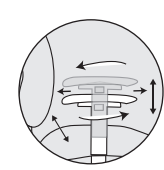

(H) Soft Touch Multi-Adjust Pivot/Swivel Arm

Casters

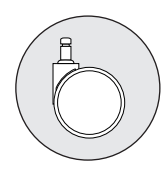

(6) Standard Caster

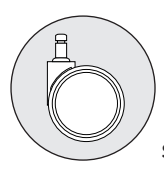

(7) Hard Floor Casters, (5 per set) **\$ 35**

Additional Options

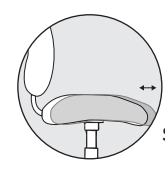

(C) Seat Slider 2.5" Side Paddle Activated **\$ 70**

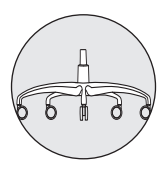

(G) 26" High Profile Polished Aluminum Base **\$ 115**



AMP (Mid Back Mesh) SIN: 711 18

Amp has a trendy, contemporary aesthetic, a lighter scale and performance based control options. This chair is ready to go.

(AM) Mid Back Mesh

Control Model

Arm Options

T01Fabric* Black only

Fabric

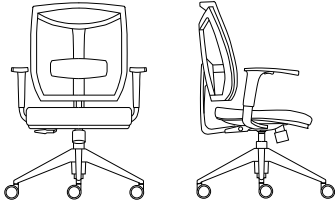

shown with optional lumbar support

(Y) Simple Synchro Control

Use for a variety of general office seating, including private office and conference room seating. Compare to swivel-tilt control.

| | | |
|---------------------------|-------|-------|
| (X) Armless | \$506 | \$564 |
| (C) Height Adj. | \$598 | \$656 |
| (P) STP Height Adj. | \$604 | \$666 |
| (Q) STP Height/Width Adj. | \$627 | \$685 |

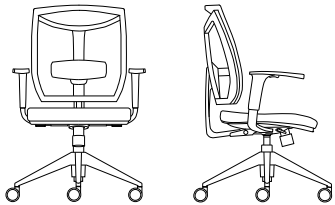

shown with optional lumbar support

(W) Full Synchro-Tilt Control

Use for a variety of general office seating, including private office and conference room seating.

| | | |
|---------------------------|-------|-------|
| (X) Armless | \$587 | \$645 |
| (C) Height Adj. | \$679 | \$737 |
| (P) STP Height Adj. | \$685 | \$743 |
| (Q) STP Height/Width Adj. | \$708 | \$766 |

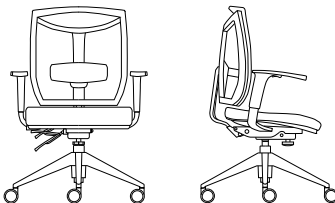

shown with optional lumbar support

(M) Multi-Function Control

Fully articulating seat and back for the highest level of ergonomic needs. Control allows user to dial in forward seat pivot from 0 to 6 degrees.

| | | |
|---------------------------|-------|-------|
| (X) Armless | \$621 | \$679 |
| (C) Height Adj. | \$713 | \$771 |
| (P) STP Height Adj. | \$719 | \$777 |
| (Q) STP Height/Width Adj. | \$742 | \$800 |

Creating AMP (Mid Back Mesh) Model

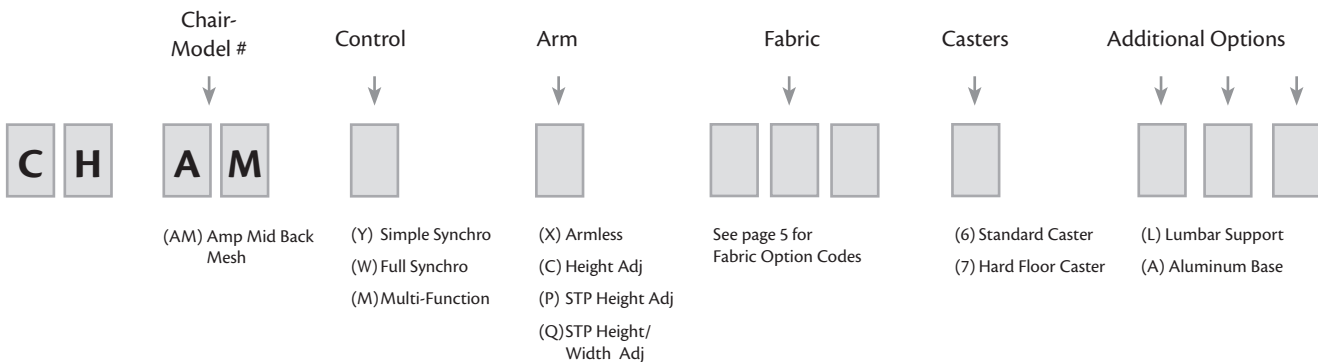

| Key | |
|-----------------|-----------------|
| W = Width | BW= Back Width |
| D= Depth | BH= Back Height |
| H= Height | |
| SW= Seat Width | WT = Weight |
| SD= Seat Depth | |
| SH= Seat Height | |

| Mechanical Functions | Dimensions | |
|--|--|--|
| <ul style="list-style-type: none"> • 360 Degree Swivel • Pneumatic Seat Height Adjustment • Tilt Tension Control • Back and Seat Tilt in 2:1 ratio • Upright Position Tilt Lock • Active Back Moves with User • Reduced Depth Seat Slider | W: 24.8 D: 24.0 H: 38.0-43.0 SW: 20.0 SD: 16.0-18.5 SH: 16.0-21.0 | BW: 18.5 BH: 19.0 WT: 37.0 lbs W/ARMS: 42.5 lbs |
| <ul style="list-style-type: none"> • 360 Degree Swivel • Pneumatic Seat Height Adjustment • Tilt Tension Control • Back and Seat Tilt in 2:1 ratio • 5 Point Tilt Position Lock • Anti-Launch Tilt Release • Active Back Moves with User • Reduced Depth Seat Slider | W: 24.8 D: 24.0 H: 38.0-43.0 SW: 20.0 SD: 16.0-18.5 SH: 16.0-21.0 | BW: 18.5 BH: 19.0 WT: 37.0 lbs W/ARMS: 42.5 lbs |
| <ul style="list-style-type: none"> • 360 Degree Swivel • Pneumatic Seat Height Adjustment • Tilt Tension Control • Seat and Back Tilt as a Unit • Infinite Tilt Position Lock • Infinite Back Angle w/ Free Float • Seat Pivots From 0 to 6 Degrees Forward • Active Back Moves with User • Reduced Depth Seat Slider | W: 24.8 D: 24.0 H: 38.0-43.0 SW: 20.0 SD: 16.0-18.5 SH: 16.0-21.0 | BW: 18.5 BH: 19.0 WT: 37.0 lbs W/ARMS: 42.5 lbs |

* T01 Upholstery Air Grid Mesh Fabric Over Foam (Black Only)

Arm Options



(C) Height Adjustable

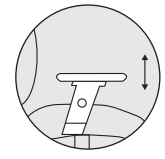

(P) Soft Touch Pad w/ 3.5" Height Adjustable Arm

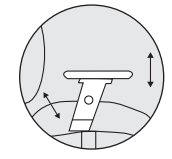

(Q) Soft Touch Pad w/ 3.5" Height & 4" Width Adjustable Arm

Casters

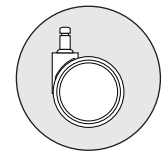

(6) Standard Caster

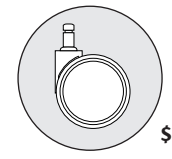

(7) Hard Floor Casters (5 per set) \$ 40

Additional Options

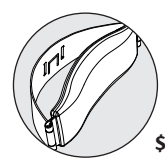

(L) Height Adjustable Lumbar Support \$ 35

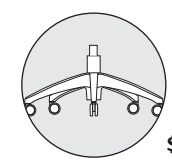

(A) 26" High Profile Polished Aluminum Base \$ 115



AMP (Mid Back Upholstered) *SIN: 711 18*

Amp has a trendy, contemporary aesthetic, a lighter scale and performance based control options. This chair is ready to go.

(AU) Mid Back Upholstered

Control Model

Arm Options

Fabric

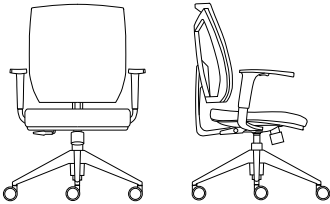

(Y) Simple Synchro Control

Use for a variety of general office seating, including private office and conference room seating. Compare to swivel-tilt control.

| | |
|---------------------------|-------|
| (X) Armless | \$644 |
| (C) Height Adj. | \$736 |
| (P) STP Height Adj. | \$742 |
| (Q) STP Height/Width Adj. | \$765 |

(W) Full Synchro-Tilt Control

Use for a variety of general office seating, including private office and conference room seating.

| | |
|---------------------------|-------|
| (X) Armless | \$725 |
| (C) Height Adj. | \$817 |
| (P) STP Height Adj. | \$823 |
| (Q) STP Height/Width Adj. | \$846 |

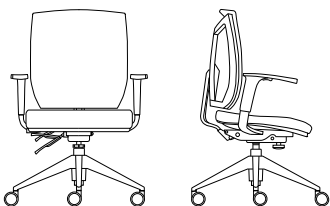

(M) Multi-Function Control

Fully articulating seat and back for the highest level of ergonomic needs. Control allows user to dial in forward seat pivot from 0 to 6 degrees.

| | |
|---------------------------|-------|
| (X) Armless | \$759 |
| (C) Height Adj. | \$851 |
| (P) STP Height Adj. | \$857 |
| (Q) STP Height/Width Adj. | \$880 |

Creating AMP (Mid Back Upholstered) Model

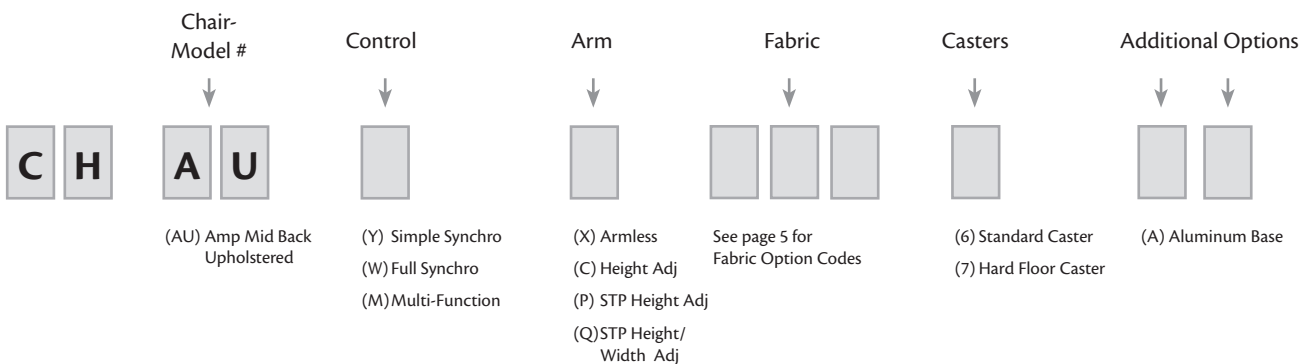

Key

| | |
|-----------------|-----------------|
| W = Width | BW= Back Width |
| D= Depth | BH= Back Height |
| H= Height | |
| SW= Seat Width | WT = Weight |
| SD= Seat Depth | |
| SH= Seat Height | |

| Mechanical Functions | Dimensions | |
|--|--|--|
| <ul style="list-style-type: none"> • 360 Degree Swivel • Pneumatic Seat Height Adjustment • Tilt Tension Control • Back and Seat Tilt in 2:1 ratio • Upright Position Tilt Lock • Active Back Moves with User • Reduced Depth Seat Slider | W: 24.8 D: 24.0 H: 38.0-43.0 SW: 20.0 SD: 16.0-18.5 SH: 16.0-21.0 | BW: 18.5 BH: 19.0 WT: 37.0 lbs W/ARMS: 42.5 lbs |
| <ul style="list-style-type: none"> • 360 Degree Swivel • Pneumatic Seat Height Adjustment • Tilt Tension Control • Back and Seat Tilt in 2:1 ratio • 5 Point Tilt Position Lock • Anti-Launch Tilt Release • Active Back Moves with User • Reduced Depth Seat Slider | W: 24.8 D: 24.0 H: 38.0-43.0 SW: 20.0 SD: 16.0-18.5 SH: 16.0-21.0 | BW: 18.5 BH: 19.0 WT: 37.0 lbs W/ARMS: 42.5 lbs |
| <ul style="list-style-type: none"> • 360 Degree Swivel • Pneumatic Seat Height Adjustment • Tilt Tension Control • Seat and Back Tilt as a Unit • Infinite Tilt Position Lock • Infinite Back Angle w/ Free Float • Seat Pivots From 0 to 6 Degrees Forward • Active Back Moves with User • Reduced Depth Seat Slider | W: 24.8 D: 24.0 H: 38.0-43.0 SW: 20.0 SD: 16.0-18.5 SH: 16.0-21.0 | BW: 18.5 BH: 19.0 WT: 37.0 lbs W/ARMS: 42.5 lbs |

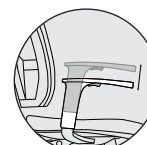
Arm Options

(C) Height Adjustable

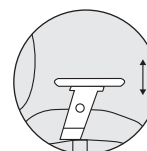
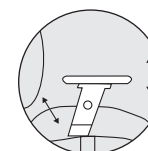
 (P) Soft Touch Pad
w/ 3.5" Height
Adjustable Arm

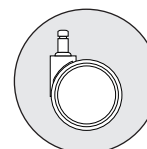
 (Q) Soft Touch Pad
w/ 3.5" Height
& 4" Width
Adjustable Arm

Casters

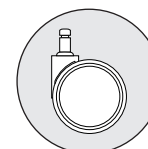
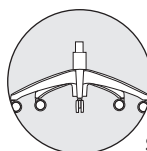
(6) Standard Caster



 (7) Hard Floor Casters
(5 per set) **\$ 40**
Additional Options

\$ 115

 (A) 26" High
Profile Polished
Aluminum Base

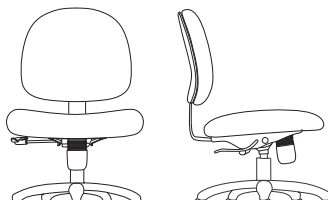
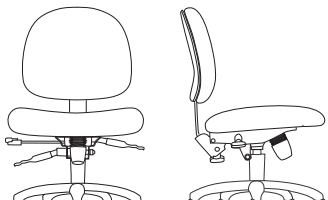
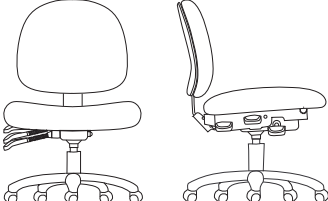

PACE (Low Back) SIN: 711 18

A classic active ergonomic favorite, Pace is both highly functional and wholly pragmatic. It's an essential part of the office landscape, where ever your office may be.

| (PL) Low Back | Control Model | Arm Options | Fabric |
|---|--|--|---|
|  | <p>(L) Swivel Tilt Control</p> <p>Use for a variety of general office seating, including private office and conference room seating.</p> | (X) Armless (B) Loop Arm (D) "C" Arm (E) STP Adjustable Arm (F) STP Multi-Adjustable Arm (T) STP Adj. Pivot/Swivel Arm (H) STP Multi Adj. Pivot/Swivel Arm | \$454 \$535 \$569 \$540 \$563 \$604 \$627 |
|  | <p>(R) Rocking Control</p> <p>For managerial and task applications. Similar to a swivel tilt control, with the added comfort of infinite back angle and tilt adjustment.</p> | (X) Armless (B) Loop Arm (D) "C" Arm (E) STP Adjustable Arm (F) STP Multi-Adjustable Arm (T) STP Adj. Pivot/Swivel Arm (H) STP Multi Adj. Pivot/Swivel Arm | \$512 \$593 \$627 \$599 \$622 \$662 \$685 |
|  | <p>(M) Multi-Function Control</p> <p>Fully articulating seat and back for the highest level of ergonomic needs. Control allows user to dial in forward seat pivot from 0 to 6 degrees. Easy touch back height adjustment.</p> | (X) Armless (B) Loop Arm (D) "C" Arm (E) STP Adjustable Arm (F) STP Multi-Adjustable Arm (T) STP Adj. Pivot/Swivel Arm (H) STP Multi Adj. Pivot/Swivel Arm | \$633 \$650 \$684 \$656 \$679 \$719 \$742 |
|  | <p>(V) Synchro-Tilt Control</p> <p>Use for a variety of general office seating, including private office and conference room seating. Seat Slider standard with Synchro-Tilt Control. Easy touch back height adjustment.</p> | (X) Armless (B) Loop Arm (D) "C" Arm (E) STP Adjustable Arm (F) STP Multi-Adjustable Arm (T) STP Adj. Pivot/Swivel Arm (H) STP Multi Adj. Pivot/Swivel Arm | \$615 \$696 \$730 \$702 \$725 \$765 \$788 |

Creating PACE (Low Back) Model

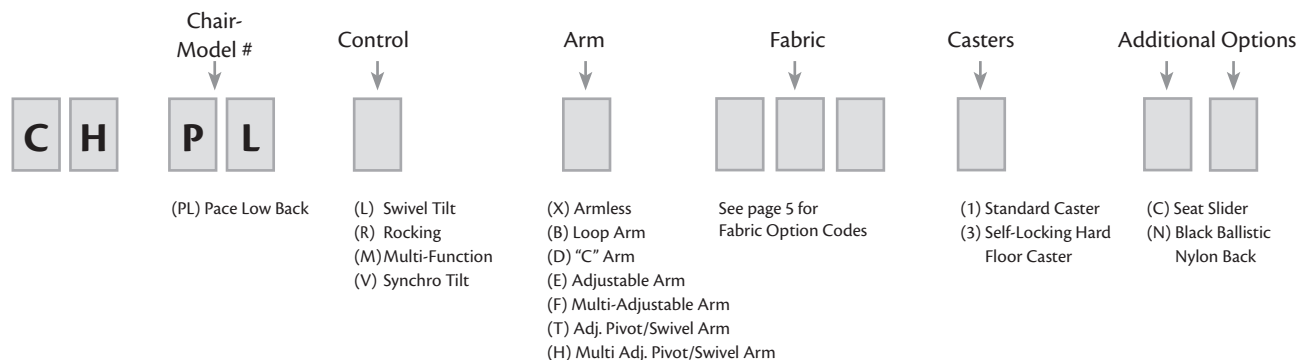

| Key | |
|-----------------|-----------------|
| W = Width | BW= Back Width |
| D= Depth | BH= Back Height |
| H= Height | WT = Weight |
| SW= Seat Width | |
| SD= Seat Depth | |
| SH= Seat Height | |

| Mechanical Functions | Dimensions | |
|---|---|--|
| <ul style="list-style-type: none"> • 360 Degree Swivel • Pneumatic Seat Height Adjustment • Tilt Tension Control • Seat and Back Tilt as a Unit • Upright Position Tilt Lock • Back Depth Adjustment | W: 27.0 D: 24.0 H: 35.0-40.0 SW: 20.5 SD: 20.0 SH: 17.0-22.0 | BW: 18.5 BH: 17.0 WT: 37.0 lbs W/ARMS: 42.5 lbs |
| <ul style="list-style-type: none"> • 360 Degree Swivel • Pneumatic Seat Height Adjustment • Infinite Seat Tilt Position Lock • Infinite Back Angle Adjustment • Seat and Back Tilt as a Unit • Ratchet Back Height Adjustment | W: 27.0 D: 24.0 H: 35.0-40.0 SW: 20.5 SD: 20.0 SH: 17.0-22.0 | BW: 18.5 BH: 17.0 WT: 37.0 lbs W/ARMS: 42.5 lbs |
| <ul style="list-style-type: none"> • 360 Degree Swivel • Pneumatic Seat Height Adjustment • Tilt Tension Control • Seat and Back Tilt as a Unit • Infinite Tilt Position Lock • Infinite Back Angle w/ Free Float • Seat pivots From 0 to 6 Deg. Forward | W: 27.0 D: 24.0 H: 35.0-40.0 SW: 20.5 SD: 20.0 SH: 17.0-22.0 | BW: 18.5 BH: 17.0 WT: 37.0 lbs W/ARMS: 42.5 lbs |
| <ul style="list-style-type: none"> • 360 Degree Swivel • Pneumatic Seat Height Adjustment • Tilt Tension Control • Back and Seat Tilt in 2:1 Ratio • 5 Point Tilt Position Lock • Anti-Launch Tilt Release • Ratchet Back Height Adjustment | W: 27.0 D: 24.0 H: 35.0-40.0 SW: 20.5 SD: 20.0 SH: 17.0-22.0 | BW: 18.5 BH: 17.0 WT: 37.0 lbs W/ARMS: 42.5 lbs |

Arm Options

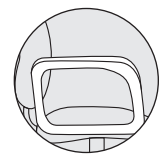

(B) Soft Touch Loop Arm

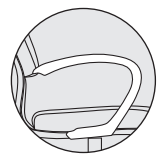

(D) Black Soft Touch C-Shape Arm

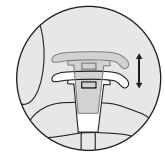

(E) Soft Touch Pad w/ 3.5" Height Adjustable Arm

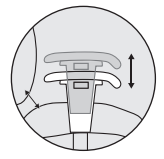

(F) Soft Touch Pad w/ 3.5" Height & 4" Width Adjustable Arm

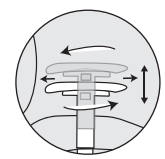

(T) Soft Touch Pad Pivot/Swivel w/ 3.5" Height Adjustable Arm

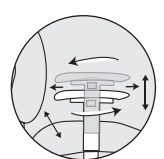

(H) Soft Touch Pad Pivot/Swivel w/ 3.5" Height & 4" Width Adjustable Arm

Casters

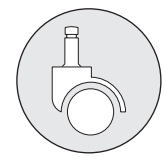

(1) Standard Caster

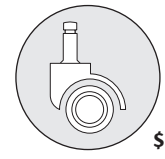

(3) Hard Floor Casters (5 per set)

\$ 35

Additional Options

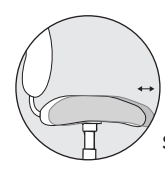

(C) Seat Slider 2.5" Side Paddle Activated

\$ 70

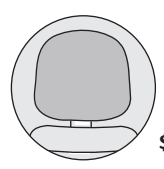





(N) Black Ballistic Nylon Back

\$ 40



PACE (Mid Back) SIN: 711 18

A classic active ergonomic favorite, Pace is both highly functional and wholly pragmatic. It's an essential part of the office landscape, where ever your office may be.

| (PM) Mid Back | Control Model | Arm Options | Fabric |
|---|--|--|---|
|  | <p>(L) Swivel Tilt Control</p> <p>Use for a variety of general office seating, including private office and conference room seating.</p> | (X) Armless (B) Loop Arm (D) "C" Arm (E) STP Adjustable Arm (F) STP Multi-Adjustable Arm (T) Adj. Pivot/Swivel Arm (H) Multi Adj. Pivot/Swivel Arm | \$518 \$599 \$633 \$605 \$628 \$668 \$691 |
|  | <p>(R) Rocking Control</p> <p>For managerial and task applications. Similar to a swivel tilt control, with the added comfort of infinite back angle and tilt adjustment.</p> | (X) Armless (B) Loop Arm (D) "C" Arm (E) STP Adjustable Arm (F) STP Multi-Adjustable Arm (T) Adj. Pivot/Swivel Arm (H) Multi Adj. Pivot/Swivel Arm | \$576 \$657 \$691 \$663 \$686 \$726 \$749 |
|  | <p>(M) Multi-Function Control</p> <p>Fully articulating seat and back for the highest level of ergonomic needs. Control allows user to dial in forward seat pivot from 0 to 6 degrees. Easy touch back height adjustment.</p> | (X) Armless (B) Loop Arm (D) "C" Arm (E) STP Adjustable Arm (F) STP Multi-Adjustable Arm (T) STP Adj. Pivot/Swivel Arm (H) STP Multi Adj. Pivot/Swivel Arm | \$633 \$714 \$748 \$720 \$743 \$783 \$806 |
|  | <p>(V) Synchro-Tilt Control</p> <p>Use for a variety of general office seating, including private office and conference room seating. Seat Slider Standard with Synchro-Tilt Control. Easy touch back height adjustment.</p> | (X) Armless (B) Loop Arm (D) "C" Arm (E) STP Adjustable Arm (F) STP Multi-Adjustable Arm (T) STP Adj. Pivot/Swivel Arm (H) STP Multi Adj. Pivot/Swivel Arm | \$679 \$760 \$794 \$766 \$789 \$829 \$852 |

Creating PACE (Mid Back) Model

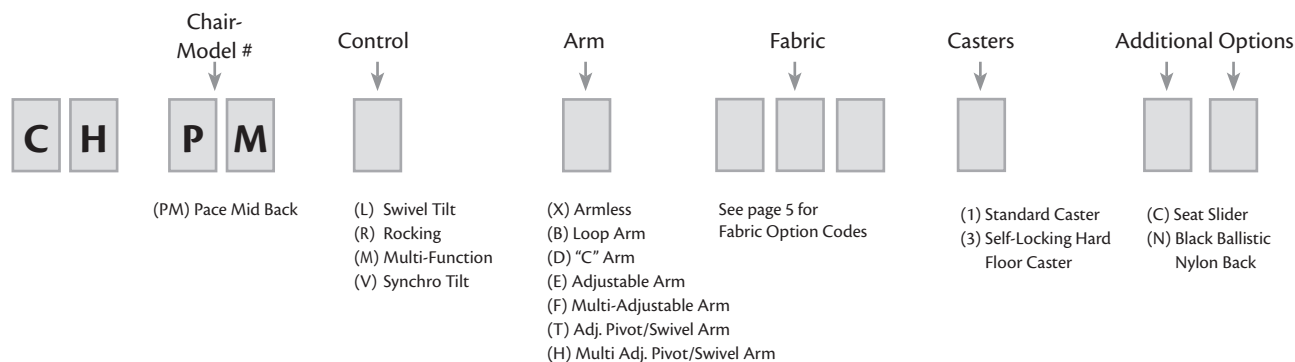

Key

| | |
|-----------------|-----------------|
| W = Width | BW= Back Width |
| D= Depth | BH= Back Height |
| H= Height | WT = Weight |
| SW= Seat Width | |
| SD= Seat Depth | |
| SH= Seat Height | |

Mechanical Functions**Dimensions**

| | | |
|------------------------------------|----------------------|-------------------------|
| • 360 Degree Swivel | W: 27.0 | BW: 20.0 |
| • Pneumatic Seat Height Adjustment | D: 23.0 | BH: 20.5 |
| • Tilt Tension Control | H: 38.3-43.3 | |
| • Seat and Back Tilt as a Unit | SW: 21.0 | |
| • Upright Position Tilt Lock | SD: 19 | WT: 41.0 lbs |
| • Back Depth Adjustment | SH: 16.0-21.0 | W/ARMS: 46.7 lbs |

| | | |
|------------------------------------|----------------------|-------------------------|
| • 360 Degree Swivel | W: 27.0 | BW: 20.0 |
| • Pneumatic Seat Height Adjustment | D: 23.0 | BH: 20.5 |
| • Infinite Seat Tilt Position Lock | H: 38.3-43.3 | |
| • Infinite Back Angle Adjustment | SW: 21.0 | |
| • Seat and Back Tilt as a Unit | SD: 19 | WT: 41.0 lbs |
| • Ratchet Back Height Adjustment | SH: 16.0-21.0 | W/ARMS: 46.7 lbs |

| | | |
|--|----------------------|-------------------------|
| • 360 Degree Swivel | W: 27.0 | BW: 20.0 |
| • Pneumatic Seat Height Adjustment | D: 23.0 | BH: 20.5 |
| • Tilt Tension Control | H: 38.3-43.3 | |
| • Seat and Back Tilt as a Unit | SW: 21.0 | |
| • Infinite Tilt Position Lock | SD: 19 | WT: 41.0 lbs |
| • Infinite Back Angle w/ Free Float | SH: 16.0-21.0 | W/ARMS: 46.7 lbs |
| • Seat pivots From 0 to 6 Deg. Forward | | |

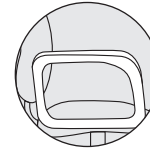
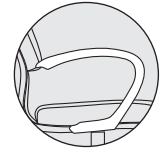
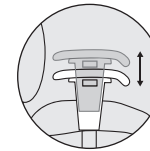
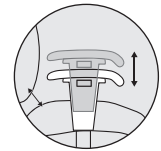
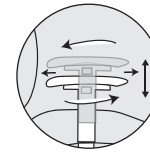
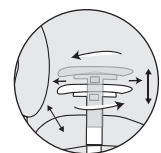
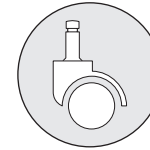
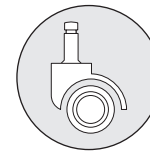
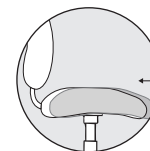
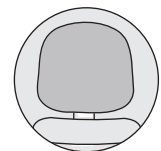

| | | |
|------------------------------------|----------------------|-------------------------|
| • 360 Degree Swivel | W: 27.0 | BW: 20.0 |
| • Pneumatic Seat Height Adjustment | D: 23.0 | BH: 20.5 |
| • Tilt Tension Control | H: 38.3-43.3 | |
| • Back and Seat Tilt in 2:1 Ratio | SW: 21.0 | |
| • 5 Point Tilt Position Lock | SD: 19 | WT: 41.0 lbs |
| • Anti-Launch Tilt Release | SH: 16.0-21.0 | W/ARMS: 46.7 lbs |
| • Ratchet Back Height Adjustment | | |

Arm Options**(B)** Soft Touch Loop Arm**(D)** Black Soft Touch C-Shape Arm**(E)** Soft Touch Pad w/ 3.5" Height Adjustable Arm**(F)** Soft Touch Pad w/ 3.5" Height & 4" Width Adjustable Arm**(T)** Soft Touch Adjustable Pivot/Swivel Arm**(H)** Soft Touch Multi-Adjustable Pivot/Swivel Arm**Casters****(1)** Standard Caster**(3)** Hard Floor Casters (5 per set)**\$ 35****Additional Options****(C)** Seat Slider 2.5" Side Paddle Activated**\$ 70****(N)** Black Ballistic Nylon Back**\$ 40**



PACE (High Back) *SIN: 711 18*

A classic active ergonomic favorite, Pace is both highly functional and wholly pragmatic. It's an essential part of the office landscape, where ever your office may be.

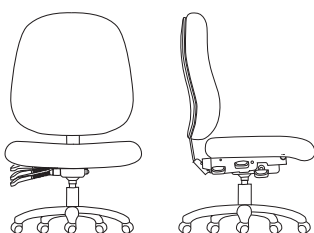
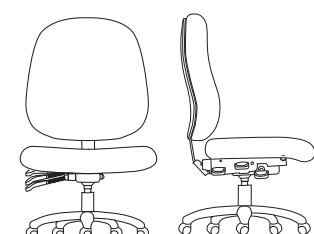
| (PH) High Back | Control Model | Arm Options | Fabric |
|---|---|--|---|
|  | (L) Swivel Tilt Control Use for a variety of general office seating, including private office and conference room seating. | (X) Armless (B) Loop Arm (D) "C" Arm (E) STP Adjustable Arm (F) STP Multi-Adjustable Arm (T) STP Adj. Pivot/Swivel Arm (H) STP Multi Adj. Pivot/Swivel Arm | \$575 \$656 \$690 \$662 \$685 \$725 \$748 |
|  | (R) Rocking Control For managerial and task applications. Similar to a swivel tilt control, with the added comfort of infinite back angle and tilt adjustment. | (X) Armless (B) Loop Arm (D) "C" Arm (E) STP Adjustable Arm (F) STP Multi-Adjustable Arm (T) STP Adj. Pivot/Swivel Arm (H) STP Multi Adj. Pivot/Swivel Arm | \$633 \$714 \$748 \$720 \$742 \$783 \$806 |
|  | (M) Multi-Function Control Fully articulating seat and back for the highest level of ergonomic needs. Control allows user to dial in forward seat pivot from 0 to 6 degrees. Easy touch back height adjustment. | (X) Armless (B) Loop Arm (D) "C" Arm (E) STP Adjustable Arm (F) STP Multi-Adjustable Arm (T) STP Adj. Pivot/Swivel Arm (H) STP Multi Adj. Pivot/Swivel Arm | \$690 \$771 \$805 \$777 \$800 \$840 \$863 |
|  | (V) Synchro-Tilt Control Use for a variety of general office seating, including private office and conference room seating. Seat Slider Standard with Synchro-Tilt Control. Easy touch back height adjustment. | (X) Armless (B) Loop Arm (D) "C" Arm (E) STP Adjustable Arm (F) STP Multi-Adjustable Arm (T) STP Adj. Pivot/Swivel Arm (H) STP Multi Adj. Pivot/Swivel Arm | \$736 \$817 \$851 \$823 \$836 \$886 \$909 |

Creating PACE (High Back) Model

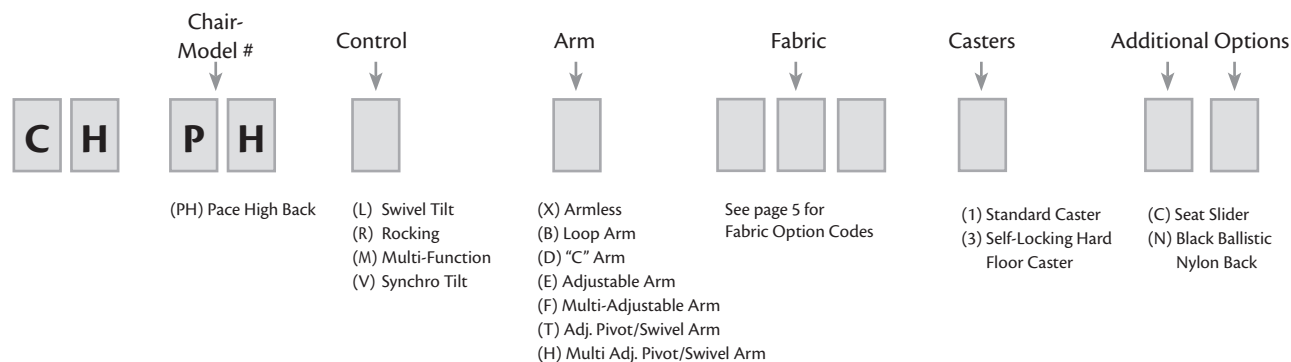

Mechanical Functions
Dimensions

| | | |
|------------------------------------|----------------------|-------------------------|
| • 360 Degree Swivel | W: 27.0 | BW: 20.0 |
| • Pneumatic Seat Height Adjustment | D: 23.0 | BH: 24.5 |
| • Tilt Tension Control | H: 42.3-47.3 | |
| • Seat and Back Tilt as a Unit | SW: 21.0 | |
| • Upright Position Tilt Lock | SD: 19 | WT: 43.0 lbs |
| • Back Depth Adjustment | SH: 16.0-21.0 | W/ARMS: 48.7 lbs |

| | | |
|------------------------------------|----------------------|-------------------------|
| • 360 Degree Swivel | W: 27.0 | BW: 20.0 |
| • Pneumatic Seat Height Adjustment | D: 23.0 | BH: 24.5 |
| • Infinite Seat Tilt Position Lock | H: 42.3-47.3 | |
| • Infinite Back Angle Adjustment | SW: 21.0 | |
| • Seat and Back Tilt as a Unit | SD: 19 | WT: 43.0 lbs |
| • Ratchet Back Height Adjustment | SH: 16.0-21.0 | W/ARMS: 48.7 lbs |

| | | |
|--|----------------------|-------------------------|
| • 360 Degree Swivel | W: 27.0 | BW: 20.0 |
| • Pneumatic Seat Height Adjustment | D: 23.0 | BH: 24.5 |
| • Tilt Tension Control | H: 42.3-47.3 | |
| • Seat and Back Tilt as a Unit | SW: 21.0 | |
| • Infinite Tilt Position Lock | SD: 19 | WT: 43.0 lbs |
| • Infinite Back Angle w/ Free Float | SH: 16.0-21.0 | W/ARMS: 48.7 lbs |
| • Seat pivots From 0 to 6 Deg. Forward | | |

| | | |
|------------------------------------|----------------------|-------------------------|
| • 360 Degree Swivel | W: 27.0 | BW: 20.0 |
| • Pneumatic Seat Height Adjustment | D: 23.0 | BH: 24.5 |
| • Tilt Tension Control | H: 42.3-47.3 | |
| • Back and Seat Tilt in 2:1 Ratio | SW: 21.0 | |
| • 5 Point Tilt Position Lock | SD: 19 | WT: 43.0 lbs |
| • Anti-Launch Tilt Release | SH: 16.0-21.0 | W/ARMS: 48.7 lbs |
| • Ratchet Back Height Adjustment | | |

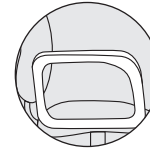
Arm Options

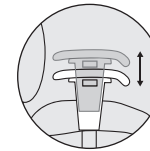
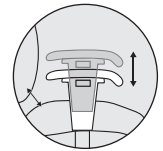
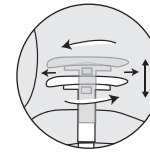
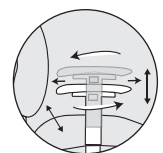
(B) Soft Touch Loop Arm

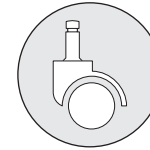
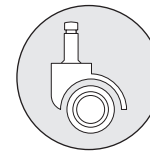
(D) Black Soft Touch C-Shape Arm

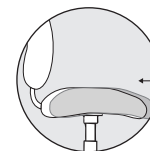
(E) Soft Touch Pad w/ 3.5" Height Adjustable Arm

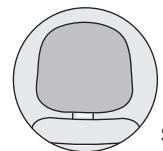
(F) Soft Touch Pad w/ 3.5" Height & 4" Width Adjustable Arm

(T) Soft Touch Adjustable Pivot/Swivel Arm

(H) Soft Touch Multi-Adjust Pivot/Swivel Arm

Casters

(1) Standard Caster

(3) Hard Floor Casters (5 per set)

\$ 35
Additional Options

(C) Seat Slider 2.5" Side Paddle Activated

\$ 70

(N) Black Ballistic Nylon Back

\$ 40

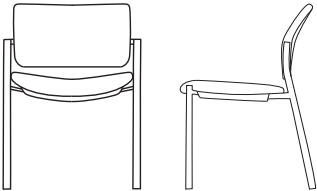
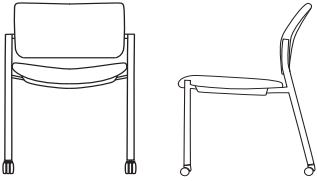
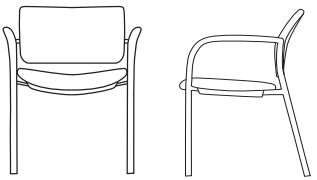
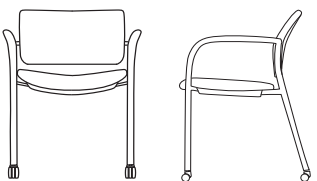

DASH SIN: 711 19

We added a pinch of style with a hint of flair to the recipe for a smart, stackable side chair. When guest seating is called for, Dash is the perfect accompaniment to the rest of our collection.

| Chair Model | | Fabric* |
|---|--|---------|
|  | <p>(DA) Armless</p> <p>fabric seat and back cushion</p> | \$374* |
|  | <p>(DB) Armless with Casters</p> <p>fabric seat and back cushion</p> | \$426* |
|  | <p>(DC) Chair with Arms</p> <p>fabric seat and back cushion</p> | \$426* |
|  | <p>(DD) Chair with Arms and Casters</p> <p>fabric seat and back cushion</p> | \$477* |

Creating DASH Model

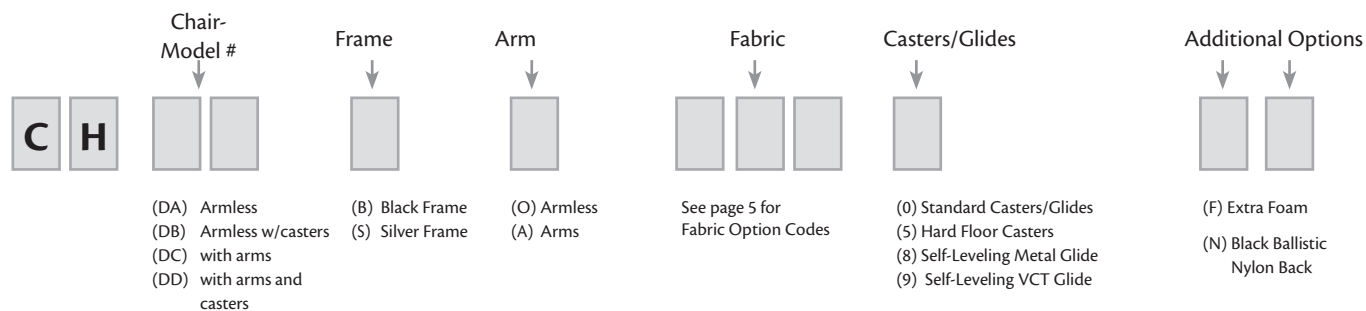

Key

| | |
|-----------------|-----------------|
| W = Width | BW= Back Width |
| D= Depth | BH= Back Height |
| H= Height | WT = Weight |
| SW= Seat Width | |
| SD= Seat Depth | |
| SH= Seat Height | |

Mechanical Functions
Dimensions

| | | |
|---|-----------------|---------------------|
| • 300 lb Weight Rating | W: 21.5 | BW: 19.5 |
| • Wall Saver Frame | D: 24.0 | BH: 16.0 |
| • Non-Marring Floor Glides | H: 33.5 | |
| • Stacks six chair high with optional dolly | SW: 19.5 | |
| • Stacks four chair high free standing | SD: 18.5 | WT: 26.0 lbs |
| | SH: 17.5 | |

| | | |
|--|-----------------|---------------------|
| • 250 lb Weight Rating | W: 21.5 | BW: 19.5 |
| • Wall Saver Frame | D: 24.0 | BH: 16.0 |
| • Standard casters for carpet | H: 33.5 | |
| • Stacks four chair high free standing | SW: 19.5 | |
| | SD: 18.5 | WT: 28.0 lbs |
| | SH: 17.5 | |

| | | |
|---|-----------------|---------------------|
| • 300 lb Weight Rating | W: 25.0 | BW: 19.5 |
| • Wall Saver Frame | D: 24.0 | BH: 16.0 |
| • Non-Marring Floor Glides | H: 33.5 | |
| • Stacks six chair high with optional dolly | SW: 19.5 | |
| • Stacks four chair high free standing | SD: 18.5 | WT: 28.0 lbs |
| | SH: 17.5 | |

| | | |
|--|-----------------|---------------------|
| • 250 lb Weight Rating | W: 25.0 | BW: 19.5 |
| • Wall Saver Frame | D: 24.0 | BH: 16.0 |
| • Standard casters for carpet | H: 33.5 | |
| • Stacks four chair high free standing | SW: 19.5 | |
| | SD: 18.5 | WT: 30.0 lbs |
| | SH: 17.5 | |

Freight surcharge - Dash:

* \$15 (Net) per chair for all orders of 4 or less BBF Dash chairs

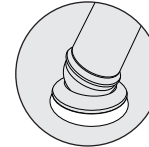
Casters/Glides

\$ 23

(8) Self-Leveling Metal
Glide (4 per set, (DA)
& (DC) only)

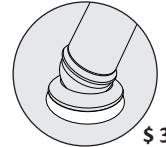

\$ 35

(9) Self-Leveling
VCT Glide
(4 per set, (DA) &
(DC) only)

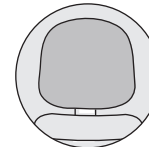
Additional Options

\$ 40

(N) Black Ballistic
Nylon Back

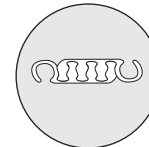
Extras- Order by model number as separate items

\$ 35

(CHGC1) Ganging Clip
Armless-to-Armless
2 per set - distance
between chairs when
ganged is 1.25"

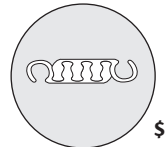

\$35

(CHGC2) Ganging Clip
arm-to-arm
2 per set - distance
between chairs when
ganged is 4.25"

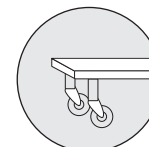

\$ 265

(CHDL1) Stacking dolly
stack chairs 6 high

GSA Awarded Terms & Conditions

Bush Industries, Inc.

Federal Supply Service—
 Authorized Federal Supply Schedule Price List
 Online access to contract ordering information, terms and conditions, up-to-date pricing, and the option to create an electronic delivery order are available through GSA Advantage!, a menu-driven database system. The Internet address for GSA Advantage! is: GSAAdvantage.gov
 Worldwide Federal Supply Schedule Contract for Schedule 71, Part 1- Office Furniture
 FSC Groups 7105, 7110, 7125, 7195
 Contract No. GS-28F-0040V

Contract Period: July 24, 2009, through July 23, 2019
Contractor: Bush Industries

Bush Industries
 c/o Federal Government Sales
 One Mason Drive, PO Box 460
 Jamestown, NY 14702-0460
 Phone: 1-888-339-2202
 Fax: 1-716-665-1111
 Email Address: GSAServices@BushIndustries.com
<http://www.bbffits.com/Markets/GSA.aspx>
 Business Size: Small
 For more information on ordering from Federal Supply Schedules click on the FSS Schedules button at fss.gsa.gov.

1. a. The following Special Item Numbers (SIN's) are hereby awarded as a part of this contract:
 - SIN 711-2 Worksurfaces, Workstations, Computer Furniture and Accessories
 - SIN 711-3 Filing and Storage Cabinets, Shelves, Mobile Carts, Dollies, Racks, and Accessories
 - SIN 711-11 Tables and Accessories
 - SIN 711-8 Executive Office Furniture
 - SIN 711-18 Multi Purpose Seating
 - SIN 711-19 Stacking Chairs
- b. N/A. For all pricing refer to: Schedule GS-28F-0040V at www.gsaadvantage.gov
- c. Hourly rates N/A

2. Maximum Order \$500,000 Net
3. Minimum Order \$1
4. Geographic coverage: Shipped to addresses with the contiguous US only, no shipments to PO boxes, APO/FPO addresses, Alaska or Hawaii
5. Points of Production: Within United States
6. Discount: 58.21% from BBF (Bush Business Furniture) GSA Pricelist updated March 2014. All commercial product will be shipped with Prepaid Freight pricing for shipments to contiguous US destinations.
7. Quantity discounts per shipment/location:

| | |
|------------------------------|--------|
| \$25,001 - \$125,786 List | 60.25% |
| \$125,787 - \$1,368,738 List | 63.48% |

Contact BBF GSA Support: 1-888-339-2202
 for more information

8. Prompt Payment Terms: Net 30
9. a. Government purchase cards accepted at or below the micro-purchase threshold
 b. Government purchase cards are accepted above the micro-purchase threshold
10. Foreign items: BBF Federal Government office furniture schedule only offers items which are made in TAA-Compliant countries.
11. a. Delivery Time: 30 days ARO (Maximum 30 days—most orders ship within 3-5 days, assembled orders deliver within 20 days from shipment. Delivery times vary depending on base security clearance.)
 b. Expedited Delivery: Contact BBF GSA Support; 1-888-339-2202 for availability and expedited freight rate.
 c. Overnight and 2-day delivery: Contact BBF GSA Support: 1-888-339-2202 for availability and expedited freight rate.
 d. Urgent Requirements: Contact BBF GSA Support; 1-888-339-2202 with details.



Schedule

Contract GS-28F-0040V

12. a. FOB points: FOB Destination
b. FOB Terms: The following FOB terms apply to all orders:
 - The above charges are limited to deliveries to a commercial delivery dock. If no dock is available or additional services are required, additional charges are applicable.
13. a. Ordering address: same as Contractor.
b. Ordering Procedures: Orders may be placed via:
 - GSA Advantage! www.gsaadvantage.gov
 - Fax: 1-716-665-1111
 - Email: GSAServices@BushIndustries.com
 - U.S. Postal: Bush Industries
One Mason Drive
Jamestown, NY 14702
14. Payment address: same as Contractor.
15. a. Warranty: The following warranty applies as shown by product line:
 - 10-Year Limited Warranty: Series A, Series C, Sector, Aspen Conference Tables and Accessories
 - Limited Lifetime Warranty: Momentum, Milano2, Realize, Quantum and Synchronize Metal Filing
 b. Cancellation Policy: No cost prior to production. After production has begun, only actual costs incurred that the contractor can demonstrate will be charged to the Government if the product cannot be sold in a reasonable length of time (6 months).
c. Return Policy/Restocking Fee: The Government customer must obtain written authorization from Bush Industries prior to returning any products and they will also be required to pay all outbound/ in-bound freight charges. A restocking fee of 20% will apply to all returned products.
16. Export packing charges: N/A
17. Terms and conditions of Government purchase card: Government purchase card accepted for all orders
18. Terms and conditions of rental, maintenance, and repair: N/A
19. Terms and conditions of installation: call for details
20. Terms and conditions of repair parts: products are guaranteed to be free of defects for the warranty period (warranty period is based on brand – refer to above or warranty card in product carton). This warranty is expressly limited to replacement of furniture parts and components. For all issues related to post sale service such as parts replacement, warranty claims, assembly tips, defective product disposition, call Consumer Service at 800-950-4782. No credit will be issued for defective product without prior authorization.
 - a. Terms and conditions of any other services: call for details
21. List of service and distribution points: Erie, PA 16509 & McCarran, NV 89434
22. List of participating dealers: call for details
23. Preventive maintenance: N/A
24. a. Special attributes: Bush Industries' manufacturing facility is currently on course to meet BIFMA Level certification. Visit <http://www.bbffits.com/About-BBF/SustainabilityMaterialRecovery.aspx> for more information regarding Bush Industries commitment to: CARB compliance, EPP Downstream Program (Composite Panel Association), Energy Consumption, Landfill Reduction, Corporate Recycling, and Sustainability.
b. Section 508 Compliance: N/A
25. DUNS number: 00211961
26. CCR Registration: Bush Industries is registered DUNS – 00211961 CAGE – 3CA68



One Mason Drive
PO BOX 460
Jamestown, NY 14702-0460
800.964.1638
Fax: 716.665.2074
www.bbffits.mobi

To reorder this catalog e-mail
literature@bushindustries.com

Series C Elite Price List

Updated April 2015



Federal Supply Service - Authorized Federal Supply Schedule Price List, Online access to contract ordering information, terms and conditions, up-to-date pricing, and the option to create an electronic delivery order are available through GSA Advantage!, a menu-driven database system.

The Internet address for GSA Advantage! is: GSAAdvantage.gov • Worldwide Federal Supply Schedule Contract for Schedule 71, Part 1- Office Furniture
FSC Groups 7105, 7110, 7125, 7195 Contract No. GS-28F-0040V • Contract Period: July 24, 2009, through July 23, 2019

Contractor: Bush Industries Federal Government Sales • One Mason Drive, PO Box 460 • Jamestown, NY • 14702-0460 • Phone: 1-888-339-2202 • Fax: 1-716-665-1111

Email Address: GSAServices@BushIndustries.com • <http://www.bbffits.com/Markets/GSA.aspx>

Business Size: Small • For more information on ordering from Federal Supply Schedules click on the FSS Schedules button at fss.gsa.gov.

What you need.

Our **total turnkey solution** has everything you need for hassle-free furniture buying. With the right products and services, we ensure you get great furniture **fast, easily, and affordably.**

.....



Where you need it.

Across the street or across the country, we specialize in small orders and fast turnarounds to **remote locations at the same flat rate.**

.....



When you need it.

Ready to ship within 24 hours of order receipt, delivered to your dock in 5 business days, **installed nationwide within 10 business days***.

*remote locations may take longer



| | |
|-------------------------------|-------|
| Terms and Conditions..... | 4-5 |
| Warranty Information | 6-7 |
| Series C Elite | 8-17 |
| GSA Terms and Conditions..... | 18-19 |

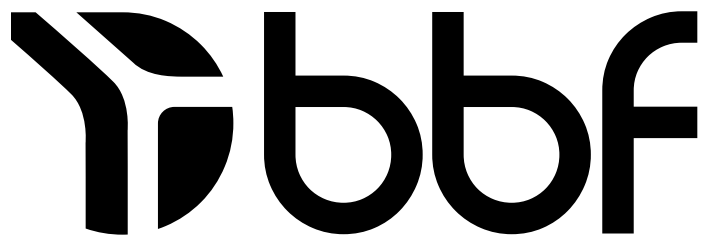
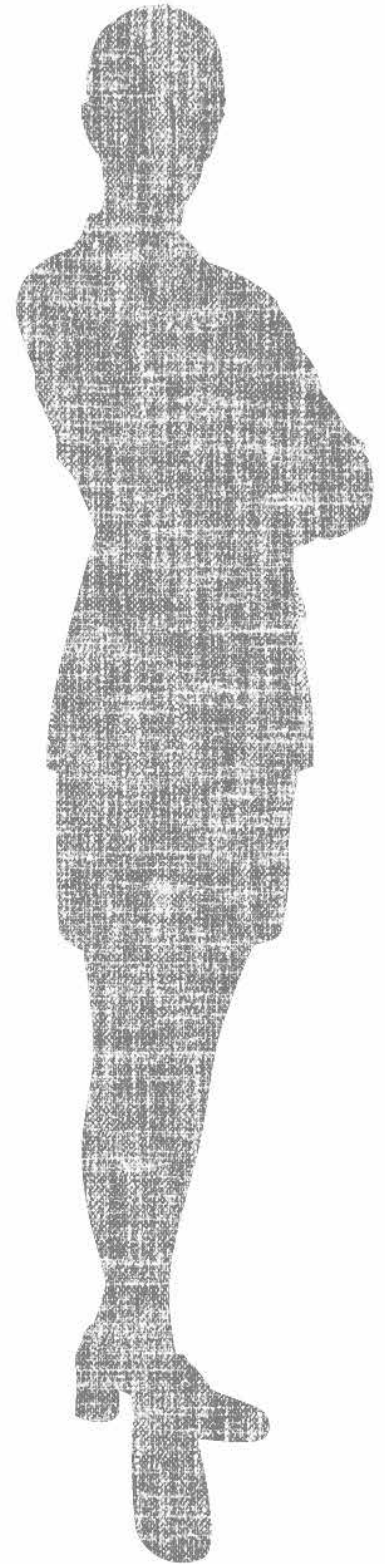

TERMS AND CONDITIONS

Pricing

- Prices shown are manufacturer's list price at time of printing.
- Prices are subject to change without notice.
- All prices shown are in US dollars.

Install 360 Service

Install 360™ pricing includes furniture delivery, assembly, installation, final adjustments to ensure optimal product performance, dusting, leveling and package removal – all in a single visit. Pricing for Install 360™ is individually quoted – please call 800-964-1638 for a price quote.



GSA Pricing:

- Products that are approved to be sold on our GSA contract are indicated through out the price list with the following symbol. 
- Products without the symbol are not on contract.
- Pricing is based on approved list pricing by the GSA.
- Product eligibility and pricing is subject to change.
- Please see page 102-103 for additional terms and conditions regarding our GSA contract.

Pre-Order Support

Space-Planning:

BBF offers a free space-planning service. Install 360™ orders of more than 25 pieces require a completed space plan before an order can be processed. Contact BBF Space-Planning at 800-964-1638 or email spaceplanning@bushindustries.com for assistance.

Order Processing

Order Receipt:

Order is transmitted to BBF in writing (preferably electronically) by Dealer. Dealer is responsible for providing correct model numbers by finish, requested delivery method, pricing and ship-to information when placing an order.

Orders can be accepted electronically through EDI, CSV flat file (Excel), PDFs emailed to bbfsales@bushindustries.com, or faxed to 716-665-1111.

New customers must also submit a credit application and signed BBF Dealer Agreement before an order can be accepted.

- Next-day shipping terms apply to orders received electronically (EDI or CSV Flat File.)
- Additional processing time may be required for orders not received electronically.
- Orders received after 12pm (ET) are considered received next business day.

Customer Service/Sales Support:

Please call 800-964-1638 for assistance with questions regarding order processing, product availability and general product information. Office hours are Monday-Friday, 8 am–5 pm ET excluding all major holidays.

Shipping:

Most STANDARD orders deliver within 3–5 business days from receipt of order. (Remote locations may take longer). Most Install 360™ orders deliver within 10 business days. Orders are invoiced at the time of shipment; See BBF Dealer Agreement for complete terms of sale.

Post-Sale Support

Return Policy:

A return authorization is required – contact BBF Support at 800-964-1638 or email bbfsales@bushindustries.com to get authorization. BBF cannot accept returns or issue credit without prior authorization. See BBF Dealer Agreement for complete terms and conditions.

Warranty Policy:

For all issues related to post-sale service such as parts replacement, warranty claims and assembly tips, please call Consumer Service 800-950-4782 or email consumerservice@bushindustries.com, Monday-Friday 8:30 am–7:30 pm ET.

TEN-YEAR COMMERCIAL WARRANTY

All Bush Industries office furniture products marketed under the Bush Business Furniture brand are warranted to the original purchaser at the time of purchase and for a period of ten years thereafter. We warrant to you, the original purchaser, that our commercial-quality furniture and all its parts and components are free of defects in material or workmanship. "Defects," as used in this warranty, are defined as any imperfections which impair the use of the furniture product.

Our warranty is expressly limited to the replacement of furniture parts and components. For ten years after the date of purchase, Bush Industries will replace any part described on the Furniture Parts List that is defective in material or workmanship. This warranty applies under conditions of normal use. Our Bush Business Furniture products are not intended for outdoor use.

This warranty does not cover:

- 1) defects caused by improper assembly or disassembly;
- 2) defects occurring after purchase due to product modification; intentional damage, accident, misuse, abuse, negligence or exposure to the elements; and
- 3) labor or assembly costs.

IMPLIED WARRANTIES, INCLUDING THE WARRANTY OF MERCHANTABILITY, SHALL NOT EXTEND BEYOND THE DURATION OF THE WRITTEN WARRANTY STATED ABOVE, AND IN NO EVENT SHALL BUSH INDUSTRIES BE LIABLE FOR INCIDENTAL OR CONSEQUENTIAL DAMAGES RESULTING FROM USE OF THE PRODUCT.

Some states do not allow a limitation on how long an implied warranty lasts or the exclusion or limitation of incidental or consequential damages, so the above limitation and exclusion may not apply to you.

IMPORTANT REMINDER: Please fill out and return your Product Registration Card promptly. Although not required, it will help us serve you even better in the future. This warranty gives you specific legal rights. You may also have other rights that may vary from state to state.

This warranty is intended to comply with the Magnuson Moss Warranty-Federal Trade Commission Improvements Act, and any provisions of this warranty or actions taken by Bush Industries pursuant to this warranty shall be construed in accordance with such act.

A dark grey rounded square badge with white text. The text reads "10-Year Commercial Warranty" with "Commercial" in a larger, bold font.

10-Year
Commercial
Warranty

FIVE-YEAR COMMERCIAL WARRANTY

All Bush Industries office furniture products marketed under the Bush Business Furniture brand are warranted to the original purchaser at the time of purchase and for a period of five years thereafter. We warrant to you, the original purchaser, that our commercial-quality furniture and all its parts and components are free of defects in material or workmanship. "Defects," as used in this warranty, are defined as any imperfections which impair the use of the furniture product.

Our warranty is expressly limited to the replacement of furniture parts and components. For five years after the date of purchase, Bush Industries will replace any part described on the Furniture Parts List that is defective in material or workmanship. This warranty applies under conditions of normal use. Our Bush Business Furniture products are not intended for outdoor use.

This warranty does not cover:

- 1) defects caused by improper assembly or disassembly;
- 2) defects occurring after purchase due to product modification; intentional damage, accident, misuse, abuse, negligence or exposure to the elements; and
- 3) labor or assembly costs.

IMPLIED WARRANTIES, INCLUDING THE WARRANTY OF MERCHANTABILITY, SHALL NOT EXTEND BEYOND THE DURATION OF THE WRITTEN WARRANTY STATED ABOVE, AND IN NO EVENT SHALL BUSH INDUSTRIES BE LIABLE FOR INCIDENTAL OR CONSEQUENTIAL DAMAGES RESULTING FROM USE OF THE PRODUCT.

Some states do not allow a limitation on how long an implied warranty lasts or the exclusion or limitation of incidental or consequential damages, so the above limitation and exclusion may not apply to you.

IMPORTANT REMINDER: Please fill out and return your Product Registration Card promptly. Although not required, it will help us serve you even better in the future. This warranty gives you specific legal rights. You may also have other rights that may vary from state to state.

This warranty is intended to comply with the Magnuson Moss Warranty-Federal Trade Commission Improvements Act, and any provisions of this warranty or actions taken by Bush Industries pursuant to this warranty shall be construed in accordance with such act.

5-Year
Commercial
Warranty

Series C Elite

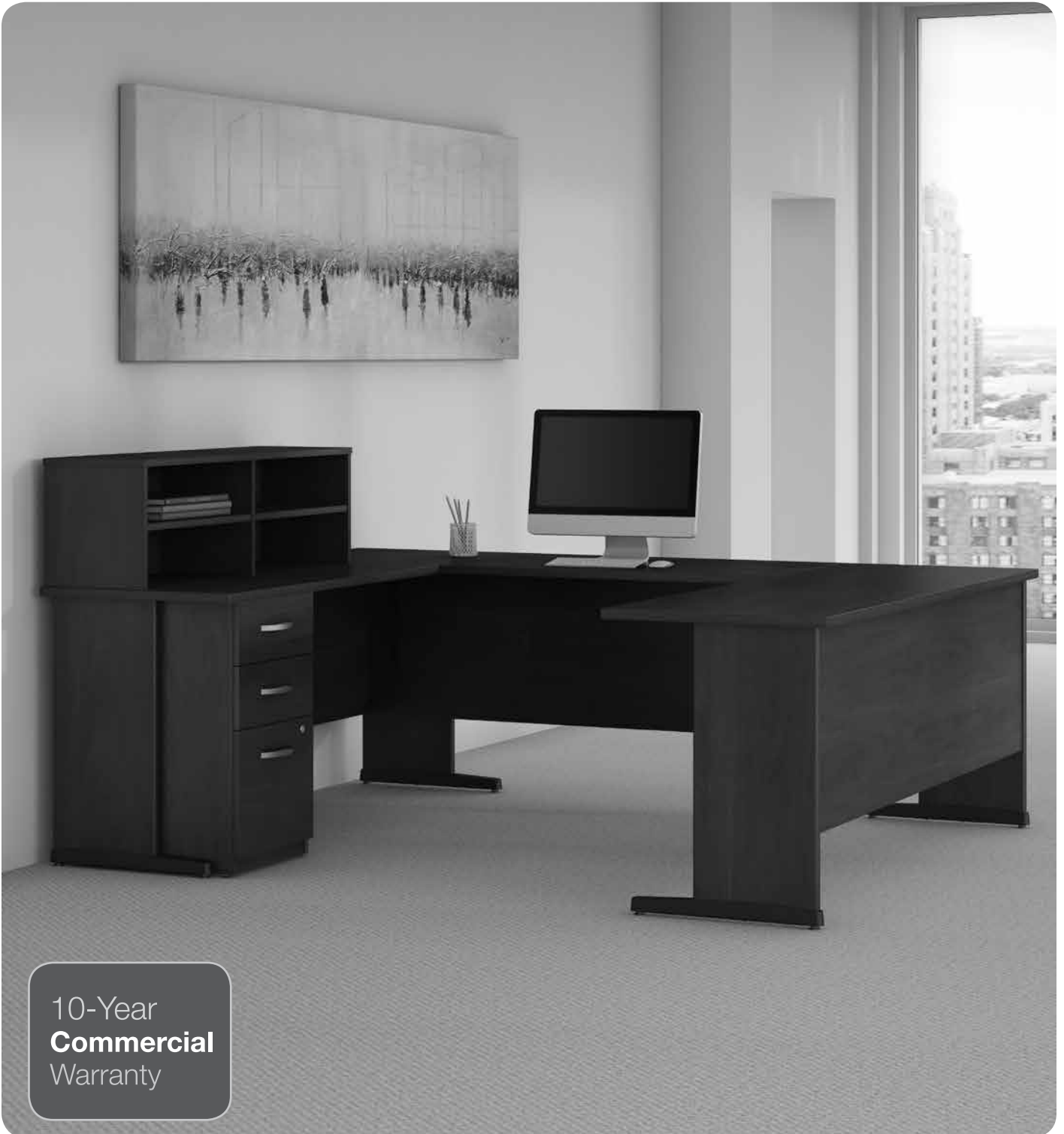

10-Year
Commercial
Warranty

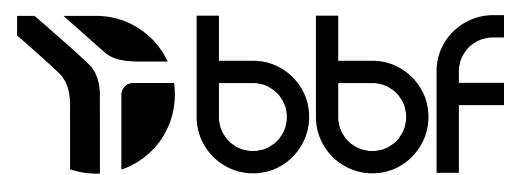

Desk Shells

- All work surfaces and leg end panels are 1" thick for strength and long term use
- Each end panel has levelers to adjust for uneven floor surfaces (1/2" adjustment range)
- Conceal cords and cables with integrated wire management grommets
- Extended modesty and side panels
- Proven quality constructed of durable, thermally fused laminate for superior resistance to scratches and stains
- Smaller width and depth options for small spaces and home offices
- Desks with wire management grommets can accept monitor arm with post (sold separately)
- New industry standard sizes for design customization

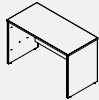
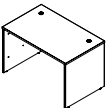
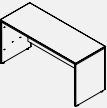
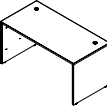
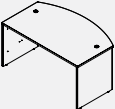
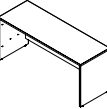
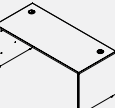
| | Description | Finish | SKU Number | Shpg Wt. (lbs) | Cube (ft.) | UPS/Fed Ex | List Price |
|---|--|-------------------------------|---------------------|----------------|------------|------------|------------|
|  | <p>48W x 24D Desk/Credenza</p> <ul style="list-style-type: none"> • Accepts 30W, 36W, 42W and 48W Bridges, 60W, 66W and 72W Desk/Credenzas • Attaches to Right or Left Corner Module (deep end) or on Left or Right L-Bow Desk • Accepts keyboard Trays in center position and 3/4 Pedestal in left or right position (sold separately) • Accepts 48W Hutch • 47.60"W x 23.35"D x 29.84"H • GSA - contract pending SIN 711-2 | Hansen Cherry Mocha Cherry | WC24509 WC12909 | 82 | 4.1 | Yes | \$362.00 |
|  | <p>48W x 30D Desk Shell</p> <ul style="list-style-type: none"> • Accepts 30W, 36W, 42W and 48W Bridge>Returns, 60W, 66W and 72W Desk/Credenza>Returns • Accepts Pencil Drawer or Keyboard Trays in center position and 3/4 Pedestal in left or right position • Attaches to 72W x 24/36D Left and Right Corner Desks • Accepts 48W Hutch • 47.68"W x 29.37"D x 29.84"H • GSA - contract pending SIN 711-2 | Hansen Cherry Mocha Cherry | WC24548 WC12948 | 102 | 5.0 | Yes | \$385.00 |
|  | <p>60W x 24D Desk/Credenza</p> <ul style="list-style-type: none"> • Accepts 30W, 36W, 42W and 48W Bridge>Returns, 48W, 60W, 66W and 72W Desk/Credenza>Returns, 60W and 72W Bowfront Desks • Attaches to Right or Left Corner Module (deep end) or on Left or Right L-Bow Desk • Accepts Pencil Drawer or Keyboard Trays in left, center and right positions and 3/4 Pedestal in left or right position • Accepts 60W Hutch • 59.45"W x 23.35"D x 29.84"H • GSA - contract pending SIN 711-2 | Hansen Cherry Mocha Cherry | WC24561 WC12961 | 116 | 5.3 | Yes | \$391.00 |
|  | <p>60W x 30D Desk Shell</p> <ul style="list-style-type: none"> • Accepts 30W, 36W, 42W and 48W Bridge>Returns, 60W, 66W and 72W Desk/Credenza>Returns • Accepts Pencil Drawer or Keyboard Trays in left, center or right position and 3/4 Pedestal in left or right position • Attaches to 72W x 24/36D Left and Right Corner Desks • Accepts 60W Hutch • 59.45"W x 29.37"D x 29.84"H • GSA - contract pending SIN 711-2 | Hansen Cherry Mocha Cherry | WC24531 WC12931 | 118 | 4.9 | Yes | \$421.00 |
|  | <p>60W x 36D Bowfront Desk</p> <ul style="list-style-type: none"> • Accepts 30W, 36W, 42W and 48W Bridge>Returns, 60W, 66W and 72W Desk/Credenza>Returns • Accepts Pencil Drawer or Keyboard Trays in left, center and right position and 3/4 Pedestal in left or right position • Attaches to 72W x 24/36D Left and Right Corner Desks • 59.45"W x 36.06"D x 29.84"H • GSA - contract pending SIN 711-2 | Hansen Cherry Mocha Cherry | WC24505 WC12905 | 127 | 5.6 | Yes | \$502.00 |
|  | <p>66W x 24D Desk Shell</p> <ul style="list-style-type: none"> • Accepts 30W, 36W, 42W and 48W Bridge>Returns, 48W, 60W, and 72W Desk/Credenza>Returns, 60W and 72W Bowfront Desks • Attaches to Right or Left Corner Module (deep end) or on Left or Right L-Bow Desk • Accepts Pencil Drawer or Keyboard Trays in left, center and right positions and 3/4 Pedestal in left or right position • Accepts 66W Hutch • 65.98"W x 23.35"D x 29.84"H • GSA - contract pending SIN 711-2 | Hansen Cherry Mocha Cherry | WC24569 WC12969 | 118 | 5.3 | Yes | \$424.00 |
|  | <p>66W x 30D Desk Shell</p> <ul style="list-style-type: none"> • Accepts 30W, 36W, 42W and 48W Bridge>Returns, 60W, 66W and 72W Desk/Credenza>Returns • Accepts Pencil Drawer or Keyboard Trays in left, center and right position and 3/4 Pedestal in left or right position • Attaches to 72W x 24/36D Left and Right Corner Desks • Accepts 66W Hutch • 65.98"W x 29.37"D x 29.80"H • GSA - contract pending SIN 711-2 | Hansen Cherry Mocha Cherry | WC24542 WC12942A | 129 | 5.3 | Yes | \$426.00 |

Desk Shells (con't)

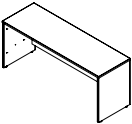
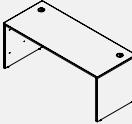
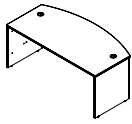
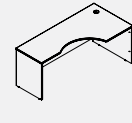
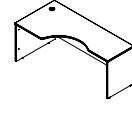
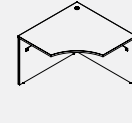
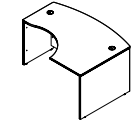
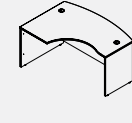
| | Description | Finish | SKU Number | Shpg Wt. (lbs) | Cube (ft.) | UPS/ Fed Ex | List Price |
|---|--|-------------------------------|--------------------|----------------|------------|-------------|------------|
|  | <p>72W x 24D Desk/Credenza</p> <ul style="list-style-type: none"> • Accepts 30W, 36W, 42W and 48W Bridge>Returns, 48W, 60W, 66W and 72W Desk/Credenza>Returns • Attaches to Right or Left Corner Module (deep end) or on Left or Right L-Bow Desk • Accepts Pencil Drawer or Keyboard Trays in left, center and right positions and 3/4 Pedestal in left or right position • Accepts 72W Hutch • 71.10"W x 23.35"D x 29.84"H • GSA - contract pending SIN 711-2 | Hansen Cherry Mocha Cherry | WC24526 WC12926 | 122 | 5.6 | Yes | \$451.00 |
|  | <p>72W x 30D Desk Shell</p> <ul style="list-style-type: none"> • Accepts 30W, 36W, 42W and 48W Bridge>Returns, 48W, 60W, 66W and 72W Desk/Credenza>Returns • Accepts Pencil Drawer or Keyboard Trays in left, center and right position and 3/4 Pedestal in left or right position • Attaches to 72W x 24/36D Left and Right Corner Desks • Accepts 72W Hutch • 71.10"W x 29.37"D x 29.84"H • GSA - contract pending SIN 711-2 | Hansen Cherry Mocha Cherry | WC24536 WC12936 | 137 | 5.7 | Yes | \$482.00 |
|  | <p>72W x 36D Bowfront Desk</p> <ul style="list-style-type: none"> • Accepts 30W, 36W, 42W and 48W Bridge>Returns, 48W, 60W, 66W and 72W Desk/Credenza>Returns • Accepts Pencil Drawer or Keyboard Trays in left, center and right position and 3/4 Pedestal in left or right position • Attaches to 72W x 24/36D Left and Right Corner Desks • 71.02"W x 36.06"D x 29.84"H • GSA - contract pending SIN 711-2 | Hansen Cherry Mocha Cherry | WC24546 WC12946 | 145 | 6.9 | Yes | \$542.00 |
|  | <p>72W x 24D Right Corner Desk</p> <ul style="list-style-type: none"> • Accepts 30W, 36W, 42W and 48W Bridge>Returns, 48W, 60W, 66W and 72W Desk/Credenza>Returns • Attaches to 48W, 60W, 66W and 72W Desks and 60W and 72W Bowfront Desks • Accepts 72W Hutch, Keyboard Trays in corner position and 3/4 Pedestal in left or right position • 71.02"W x 35.47"D x 29.84"H • GSA - contract pending SIN 711-2 | Hansen Cherry Mocha Cherry | WC24523 WC12923 | 145 | 6.9 | Yes | \$546.00 |
|  | <p>72W x 24D Left Corner Desk</p> <ul style="list-style-type: none"> • Accepts 30W, 36W, 42W and 48W Bridge>Returns, 48W, 60W, 66W and 72W Desk/Credenza>Returns • Attaches to 48W, 60W, 66W and 72W Desks and 60W and 72W Bowfront Desks • Accepts 72W Hutch, Keyboard Trays in corner position and 3/4 Pedestal in left or right position • 71.02"W x 35.47"D x 29.84"H • GSA - contract pending SIN 711-2 | Hansen Cherry Mocha Cherry | WC24532 WC12932 | 145 | 6.9 | Yes | \$546.00 |
|  | <p>42W Corner Connector</p> <ul style="list-style-type: none"> • Not freestanding. Must be attached at both ends to a Desk/Credenza/Return or Return/Bridge • Attaches to 30W, 36W and 42W Bridge>Returns, 48W Return and Privacy Bridge/Return • Attaches to 60W, 66W and 72W Desk/Credenza/Return • Accepts 72W Hutch when used with 30W Bridge/Return • Accepts Keyboard Trays in center position (sold separately) • 41.65"W x 41.65"D x 29.84"H • GSA - contract pending SIN 711-2 | Hansen Cherry Mocha Cherry | WC24541 WC12941 | 116 | 5.7 | Yes | \$461.00 |
|  | <p>60W x 43D RH L-Bow Desk</p> <ul style="list-style-type: none"> • Accepts any Credenza or Return Bridge on right side • Accepts Keyboard Tray or Articulating Keyboard Trays in corner position • 58.86"W x 42.87"D x 29.84"H • GSA - contract pending SIN 711-2 | Hansen Cherry Mocha Cherry | WC24522 WC12922 | 132 | 6.3 | Yes | \$499.00 |
|  | <p>60W x 43D LH L-Bow Desk</p> <ul style="list-style-type: none"> • Accepts any Credenza or Return Bridge on left side • Accepts Keyboard Trays in corner position • 58.86"W x 42.87"D x 29.84"H • GSA - contract pending SIN 711-2 | Hansen Cherry Mocha Cherry | WC24533 WC12933 | 132 | 6.3 | Yes | \$499.00 |

Bridge/Returns

Proven quality constructed of durable, thermally fused laminate for superior resistance to scratches and stains

Not freestanding, must be attached to another work surface

| | Description | Finish | SKU Number | Shpg Wt. (lbs) | Cube (ft.) | UPS/ Fed Ex | List Price |
|---|---|-------------------------------|--------------------|----------------|------------|-------------|------------|
|  | <p>30W x 24D Bridge/Return</p> <ul style="list-style-type: none"> Attaches to 48W, 60W, 66W and 72W Desk Shells or Credenzas, 60W or 72W Bowfront Desks Attaches to Right or Left Corner Module (deep end) or on Left or Right L-Bow Desk Must be attached to another work surface Accepts Keyboard Trays (sold separately) in center position and 3/4 Pedestal in left or right position 29.65"W x 23.35"D x 29.84"H GSA - contract pending SIN 711-2 | Hansen Cherry Mocha Cherry | WC24507 WC12907 | 63 | 2.9 | Yes | \$217.00 |
|  | <p>36W x 24D Bridge/Return</p> <ul style="list-style-type: none"> Attaches to 48W, 60W, 66W and 72W Desk Shells or Credenzas, 60W or 72W Bowfront Desks Attaches to Right or Left Corner Module (deep end) or on Left or Right L-Bow Desk Must be attached to another work surface Accepts Keyboard Trays (sold separately) in center position and 3/4 Pedestal in left or right position 35.43"W x 23.35"D x 29.84"H GSA - contract pending SIN 711-2 | Hansen Cherry Mocha Cherry | WC24518 WC12918 | 70 | 3.4 | Yes | \$217.00 |
|  | <p>42W x 24D Bridge/Return</p> <ul style="list-style-type: none"> Attaches to 48W, 60W, 66W and 72W Desk Shells or Credenzas, 60W or 72W Bowfront Desks Attaches to Right or Left Corner Module (deep end) or on Left or Right L-Bow Desk Must be attached to another work surface Accepts Keyboard Trays in center position and 3/4 Pedestal in left or right position 41.65"W x 23.35"D x 29.84"H GSA - contract pending SIN 711-2 | Hansen Cherry Mocha Cherry | WC24544 WC12944 | 77 | 3.9 | Yes | \$257.00 |
|  | <p>48W x 24D Bridge/Return</p> <ul style="list-style-type: none"> Attaches to 48W, 60W, 66W and 72W Desk Shells or Credenzas, 60W or 72W Bowfront Desks Attaches to Right or Left Corner Module (deep end) or on Left or Right L-Bow Desk Must be attached to another work surface Accepts Keyboard Trays in center position and 3/4 Pedestal in left or right position 47.68"W x 23.35"D x 29.84"H GSA - contract pending SIN 711-2 | Hansen Cherry Mocha Cherry | WC24524 WC12924 | 84 | 4.3 | Yes | \$263.00 |
|  | <p>48W x 24D Privacy Bridge/Return</p> <ul style="list-style-type: none"> Attaches to 48W, 60W, 66W and 72W Desk Shells or Credenzas, 60W or 72W Bowfront Desks Attaches to Right or Left Corner Module (deep end) or on Left or Right L-Bow Desk Must be attached to another work surface Optional tackboard available (sold separately) 47.60"W x 23.35"D x 40.18"H GSA - contract pending SIN 711-2 | Hansen Cherry Mocha Cherry | WC24508 WC12908 | 116 | 5.5 | Yes | \$392.00 |
|  | <p>48W x 30D Peninsula Return</p> <ul style="list-style-type: none"> Attaches to 48W, 60W, 66W and 72W Desks Shells and Credenzas or 60W and 72W Bowfront Desks to form a L-Workstation 47.68"W x 29.37"D x 29.69"H GSA - contract pending SIN 711-2 | Hansen Cherry Mocha Cherry | WC24570 WC12970 | 60 | 3.6 | Yes | \$279.00 |
|  | <p>72W x 30D Peninsula</p> <ul style="list-style-type: none"> Attaches to 48W, 60W, 66W and 72W Desks, Credenzas and Returns 71.02"W x 29.37"D x 29.76"H GSA - contract pending SIN 711-2 | Hansen Cherry Mocha Cherry | WC24571 WC12971 | 113 | 6.0 | Yes | \$466.00 |

Table Desks

- ☑ Durable thermally-fused laminate worksurface features superior resistance to scratches and stains
- ☑ All worksurfaces and leg panels are one inch thick for strength and long term use
- ☑ A flexible, healthy and ergonomic solution for today's work environments
- ☑ 41" High worksurfaces allow user to comfortably stand while working
- ☑ Shelving allows attachment of bridge/returns to mix sit to stand functionality
- ☑ Available with shelving for privacy/storage or open for barstool height meeting/work table
- ☑ Low-cost method for those that need to sit and stand throughout the day
- ☑ Available in two sizes (72W x 30D, 60W x 24D)
- ☑ For freestanding (not placed against a wall) desks using pedestals underneath, order 2 Shelf Kits

| | Description | Finish | SKU Number | Shpg Wt. (lbs) | Cube (ft.) | UPS/ Fed Ex | List Price |
|---|--|-------------------------------|----------------------|----------------------------|------------------------------|-------------|------------|
|  | 60W x 24D Standing Desk <ul style="list-style-type: none"> • Accepts 16W and 24W Pedestals with tops removed or two Standing Desk Shelf Kits (one on each side of desk) • 59.45"W x 23.35"D x 41.18"H • GSA - contract pending SIN 711-2 | Hansen Cherry Mocha Cherry | WC24515 WC12915 | 110 | 5.2 | Yes | \$543.00 |
|  | 72W x 30D Standing Desk <ul style="list-style-type: none"> • Accepts 16W and 24W Pedestal with tops removed and Standing Table Desk Shelf Kits (one on each side of desk) • 71.02"W x 29.37"D x 40.67"H • GSA - contract pending SIN 711-2 | Hansen Cherry Mocha Cherry | WC24575K WC12975K | Box 1 64 Box 2 89 | Box 1 3.0 Box 2 4.6 | Yes | \$723.00 |
|  | 60W Standing Desk Shelf Kit <ul style="list-style-type: none"> • Attaches under 60W Standing Table Desk • Two adjustable shelves • 57.20"W x 11.24"D x 11.34"H • GSA - contract pending SIN 711-2 | Hansen Cherry Mocha Cherry | WC24516 WC12916 | 37 | 2.5 | Yes | \$254.00 |
|  | 72W Standing Desk Shelf Kit <ul style="list-style-type: none"> • Attaches under 72W Standing Table Desk • Two adjustable shelves • 68.78"W x 14.13"D x 11.34"H • GSA - contract pending SIN 711-2 | Hansen Cherry Mocha Cherry | WC24580 WC12980 | 55 | 3.5 | Yes | \$321.00 |

C-Leg Desks

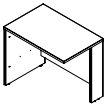
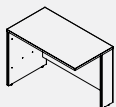
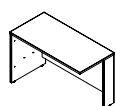
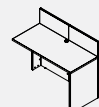
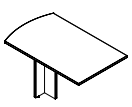
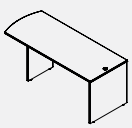
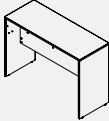
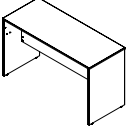
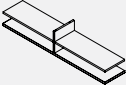
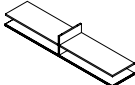
- Clean contemporary design and uniform color
- Lightly scaled and open with added legroom
- New 30" and 24" depth work surfaces provide greater work style variations
- New bridge and return options for efficient Corner, L and U shaped configurations
- Thermally fused laminate for superior resistance to scratches and stains
- All work surfaces and leg end panels are 1" thick for strength and long term use
- Each foot has levelers to adjust for uneven floor surfaces

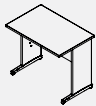
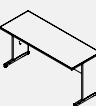
| | Description | Finish | SKU Number | Shpg Wt. (lbs) | Cube (ft.) | UPS/Fed Ex | List Price |
|---|---|-------------------------------|--------------------|----------------|------------|------------|------------|
|  | 36W x 24D C-Leg Desk <ul style="list-style-type: none"> • Accepts 36W Hutch • Works with 3/4 Pedestal in either a left or right position • Accepts Keyboard Tray accessory in a center position (sold separately) • 32.36"W x 23.39"D x 29.70"H • GSA - contract pending SIN 711-2 | Hansen Cherry Mocha Cherry | WC24529 WC12929 | 53 | 2.9 | Yes | \$321.00 |
|  | 36W x 30D C-Leg Desk <ul style="list-style-type: none"> • Accepts 36W Hutch • Works with 3/4 Pedestal in either a left or right position • Accepts Keyboard Tray accessory in a center position (sold separately) • 35.43"W x 29.37"D x 29.37"H • GSA - contract pending SIN 711-2 | Hansen Cherry Mocha Cherry | WC24530 WC12930 | 67 | 3.2 | Yes | \$326.00 |
|  | 48W x 24D C-Leg Desk <ul style="list-style-type: none"> • Accepts 48W Hutch • Works with 3/4 Pedestal in either a left or right position • Accepts Keyboard Tray accessory in a center position (sold separately) • 47.60"W x 23.35"D x 29.53"H • GSA - contract pending SIN 711-2 | Hansen Cherry Mocha Cherry | WC24549 WC12949 | 68 | 3.7 | Yes | \$331.00 |
|  | 48W x 30D C-Leg Desk <ul style="list-style-type: none"> • Accepts 48W Hutch • Works with 3/4 Pedestal in either a left or right position • Accepts Keyboard Tray accessory in a center position (sold separately) • 47.60"W x 29.37"D x 29.53"H • GSA - contract pending SIN 711-2 | Hansen Cherry Mocha Cherry | WC24550 WC12950 | 78 | 4.1 | Yes | \$362.00 |
|  | 60W x 24D C-Leg Desk <ul style="list-style-type: none"> • Accepts 60W Hutch • Works with 3/4 Pedestal in either a left or right position • Accepts Keyboard Tray accessory in a left, center or right position (sold separately) • 59.45"W x 23.35"D x 29.53"H • GSA - contract pending SIN 711-2 | Hansen Cherry Mocha Cherry | WC24563 WC12963 | 89 | 4.2 | Yes | \$388.00 |
|  | 60W x 30D C-Leg Desk <ul style="list-style-type: none"> • Accepts 60W Hutch • Works with 3/4 Pedestal in either a left or right position • Accepts Keyboard Tray accessory in a left, center or right position (sold separately) • 59.45"W x 29.37"D x 29.53"H • GSA - contract pending SIN 711-2 | Hansen Cherry Mocha Cherry | WC24564 WC12964 | 95 | 5.1 | Yes | \$413.00 |

C-Leg Desks (con't)

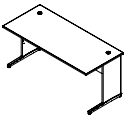
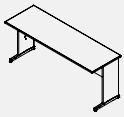
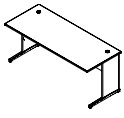
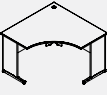
| | Description | Finish | SKU Number | Shpg Wt. (lbs) | Cube (ft.) | UPS/ Fed Ex | List Price |
|---|---|-------------------------------|--------------------|----------------|------------|-------------|------------|
|  | <p>60W x 36D C-Leg Bowfront Desk</p> <ul style="list-style-type: none"> • Accepts 36W and 42W C-Leg Returns to form a L-Workstation or a 42W C-Leg Bridge to create a U-Workstation • Accepts Keyboard Tray accessory in a left, center or right position (sold separately) • 59.45"W x 34.06"D x 29.53"H • GSA - contract pending SIN 711-2 | Hansen Cherry Mocha Cherry | WC24565 WC12965 | 103 | 5.8 | Yes | \$502.00 |
|  | <p>66W x 30D C-Leg Desk</p> <ul style="list-style-type: none"> • Accepts 66W Hutch • Works with 3/4 Pedestal in either a left or right position • Accepts Keyboard Tray accessory in a left, center or right position (sold separately) • 65.98"W x 29.37"D x 29.53"H • GSA - contract pending SIN 711-2 | Hansen Cherry Mocha Cherry | WC24567 WC12967 | 102 | 5.6 | Yes | \$435.00 |
|  | <p>72W x 24D C-Leg Desk</p> <ul style="list-style-type: none"> • Accepts 72W Hutch • Works with 3/4 Pedestal in either a left or right position • Accepts Keyboard Tray accessory in a left, center or right position (sold separately) • 71.02"W x 23.35"D x 29.53"H • GSA - contract pending SIN 711-2 | Hansen Cherry Mocha Cherry | WC24573 WC12973 | 97 | 4.9 | Yes | \$419.00 |
|  | <p>72W x 30D C-Leg Desk</p> <ul style="list-style-type: none"> • Accepts 72W Hutch • Works with 3/4 Pedestal in either a left or right position • Accepts Keyboard Tray accessory in a left, center or right position (sold separately) • 71.02"W x 29.37"D x 29.53"H • GSA - contract pending SIN 711-2 | Hansen Cherry Mocha Cherry | WC24574 WC12974 | 109 | 6.0 | Yes | \$450.00 |
|  | <p>48W C-Leg Corner Desk</p> <ul style="list-style-type: none"> • Accepts 48W Corner Hutch or 48W Hutch on side • Accepts Keyboard Tray accessory in a corner position (sold separately) • 47.17"W x 47.17"D x 29.53"H • GSA - contract pending SIN 711-2 | Hansen Cherry Mocha Cherry | WC24551 WC12951 | 115 | 5.9 | Yes | \$497.00 |

C-Leg Bridges/Returns

- Durable thermally-fused laminate worksurface features superior resistance to scratches and stains
- All work surfaces and leg end panels are 1" thick for strength and long term use
- Not freestanding, must be attached to another work surface

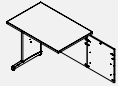
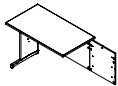
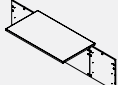
| | Description | Finish | SKU Number | Shpg Wt. (lbs) | Cube (ft.) | UPS/ Fed Ex | List Price |
|---|---|-------------------------------|--------------------|----------------|------------|-------------|------------|
|  | 36W x 24D C-Leg Return <ul style="list-style-type: none"> • Must be attached to another work surface • Works with 3/4 Pedestal in either a left or right position • Attaches to any 24D or 30D C-Leg Desk to create a U-Workstation • 35.43"W x 23.35"D x 28.27"H • GSA - contract pending SIN 711-2 | Hansen Cherry Mocha Cherry | WC24535 WC12935 | 62 | 3.2 | Yes | \$285.00 |
|  | 42W x 24D C-Leg Return <ul style="list-style-type: none"> • Must be attached to another work surface • Attaches to any 24D or 30D C-Leg Desk to create an L-Workstation • Works with 3/4 Pedestal in either a left or right position • 41.50"W x 23.35"D x 27.95"H • GSA - contract pending SIN 711-2 | Hansen Cherry Mocha Cherry | WC24540 WC12940 | 68 | 3.7 | Yes | \$305.00 |
|  | 42W x 24D C-Leg Bridge <ul style="list-style-type: none"> • Must be attached to another work surface • Attaches to any 24D or 30D C-Leg Desk to create a U-Workstation • 41.50"W x 23.23"D x 20.67"H • GSA - contract pending SIN 711-2 | Hansen Cherry Mocha Cherry | WC24543 WC12943 | 53 | 2.6 | Yes | \$223.00 |

Hutches

- All doors feature self-closing Euro-style hinges
- Coordinating tackboards available (sold separately)
- Hutches to fit all desks and 36W Storage pieces

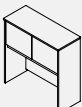
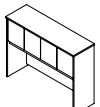
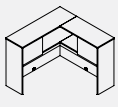

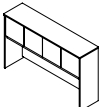
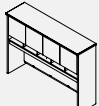
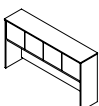
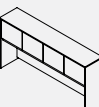
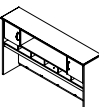
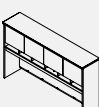
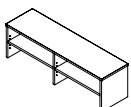
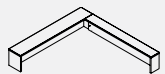

| | Description | Finish | SKU Number | Shpg Wt. (lbs) | Cube (ft.) | UPS/ Fed Ex | List Price |
|---|--|-------------------------------|--------------------|----------------|------------|-------------|------------|
|  | 36W Hutch <ul style="list-style-type: none"> • Mounts on 36W or larger Desks, 36W Storage Cabinet and 36W 2 Drawer Lateral File • Two doors conceal open storage compartment • Accepts one task light (sold separately) • 35.35"W x 10.59"D x 36.02"H • GSA - contract pending SIN 711-2 | Hansen Cherry Mocha Cherry | WC24537 WC12937 | 71 | 3.4 | Yes | \$404.00 |
|  | 48W Hutch <ul style="list-style-type: none"> • Mounts on 48W or larger Desk, Credenza or Return • Four doors conceal open storage compartment • Accepts one task light (sold separately) • 47.09"W x 14.53"D x 36.02"H • GSA - contract pending SIN 711-2 | Hansen Cherry Mocha Cherry | WC24547 WC12947 | 98 | 4.5 | Yes | \$481.00 |
|  | 48W Corner Hutch <ul style="list-style-type: none"> • Mounts on 48W Corner Desk • Two doors conceal open storage compartment • Accepts two task lights (sold separately) • 47.09"W x 47.09"D x 36.06"H • GSA - contract pending SIN 711-2 | Hansen Cherry Mocha Cherry | WC24545 WC12945 | 135 | 6.2 | Yes | \$725.00 |

Hutches (con't)

| | Description | Finish | SKU Number | Shpg Wt. (lbs) | Cube (ft.) | UPS/ Fed Ex | List Price |
|---|---|-------------------------------|----------------------|----------------|------------|-------------|------------|
|  | <p>60W Hutch</p> <ul style="list-style-type: none"> Mounts on 60W or larger Desk, Credenza or Return Four doors conceal open storage compartment Accepts two task lights (sold separately) 58.70"W x 14.53"D x 36.02"H GSA - contract pending SIN 711-2 | Hansen Cherry Mocha Cherry | WC24579 WC12979 | 105 | 5.2 | Yes | \$549.00 |
|  | <p>60W Hutch with Work-in-Progress</p> <ul style="list-style-type: none"> Mounts onto the 60W or larger Desk, Credenza or Return Four doors conceal open storage compartment Accepts two task lights (sold separately) 58.86"W x 15.35"D x 43.01"H GSA - contract pending SIN 711-2 | Hansen Cherry Mocha Cherry | WC24462K WC12962K | 152 | 5.2 | Yes | \$588.00 |
|  | <p>66W Hutch</p> <ul style="list-style-type: none"> Mounts on 66W or larger Desk, Credenza or Return Four doors conceal open storage compartment Accepts two task lights (sold separately) 64.72"W x 14.53"D x 36.02"H GSA - contract pending SIN 711-2 | Hansen Cherry Mocha Cherry | WC24568 WC12968 | 113 | 5.0 | Yes | \$611.00 |
|  | <p>72W Hutch</p> <ul style="list-style-type: none"> Mounts on 72W or larger Desk, Credenza or Return Four doors conceal open storage compartment Accepts two task lights (sold separately) 70.94"W x 14.53"D x 36.02"H GSA - contract pending SIN 711-2 | Hansen Cherry Mocha Cherry | WC24578 WC12978 | 121 | 6.1 | Yes | \$664.00 |
|  | <p>72W Hutch (2-Door) with Work-in-Progress</p> <ul style="list-style-type: none"> 71.02"W x 15.35"D x 43.01"H Mounts on 72W or larger Desk, Credenza or Return Two doors conceal open storage compartment Accepts two task lights (sold separately) GSA - contract pending SIN 711-2 | Hansen Cherry Mocha Cherry | WC24466K WC12966K | 175 | 6.2 | Yes | \$738.00 |
|  | <p>72W Hutch (4-Door) with Work-in-Progress</p> <ul style="list-style-type: none"> 71.02"W x 15.35"D x 43.01"H Mounts on 72W Desk Shell, 72W Credenza Shell, RH/LH Corner Module, two 36W 2-Drawer Lateral Files placed side-by-side, or one 2-Drawer Lateral File placed adjacent to the deep end of a Corner Module Accepts two task lights (sold separately) GSA - contract pending SIN 711-2 | Hansen Cherry Mocha Cherry | WC24477K WC12977K | 181 | 6.2 | Yes | \$738.00 |
|  | <p>60W Desk Top Organizer</p> <ul style="list-style-type: none"> Mounts on 60W, 66W or 72W Desk and Credenza Two adjustable or removeable shelves 45.39"W x 12.64"D x 13.82"H GSA - contract pending SIN 711-2 | Hansen Cherry Mocha Cherry | WC24510 WC12910 | 41 | 1.9 | Yes | \$285.00 |
|  | <p>Reception Station</p> <ul style="list-style-type: none"> Mounts on 72W Desk Shell with 48W Return Bridge Front gallery alone will mount on 72W Desk Shell Assembles right or left-handed 76.89"W x 71.02"D x 13.88"H GSA - contract pending SIN 711-2 | Hansen Cherry Mocha Cherry | WC24476 WC12976 | 82 | 3.1 | Yes | \$482.00 |

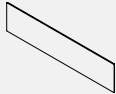
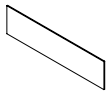
Tackboards

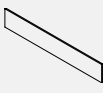
- Tackboard covered in commercial grade upholstery fabric
- Easily attaches to the Hutch with included clips & screws
- Convenient surface for posting messages, memos and reminders

| | Description | Finish | SKU Number | Shpg Wt. (lbs) | Cube (ft.) | UPS/ Fed Ex | List Price |
|---|--|--------------|------------|----------------|------------|-------------|------------|
|  | 72W Hutch Tackboard • 68.19"W x 0.51"D x 15.51"H • GSA - contract pending SIN 711-2 | Lyric Sundew | WCTB72LS | 11 | 1.8 | Yes | \$150.00 |
|  | 66W Hutch Tackboard • 61.97"W x 0.51"D x 15.51"H • GSA - contract pending SIN 711-2 | Lyric Sundew | WCTB66LS | 10 | 1.7 | Yes | \$140.00 |
|  | 60W Hutch Tackboard • 55.94"W x 0.51"D x 15.51"H • GSA - contract pending SIN 711-2 | Lyric Sundew | WCTB60LS | 9 | 1.5 | Yes | \$129.00 |
|  | 48W Hutch Tackboard • 44.33"W x 0.51"D x 15.51"H • GSA - contract pending SIN 711-2 | Lyric Sundew | WCTB48LS | 8 | 1.2 | Yes | \$109.00 |
|  | 48W Privacy/Return Tackboard • 46.57"W x 0.51"D x 7.64"H • GSA - contract pending SIN 711-2 | Lyric Sundew | WCPT48LS | 5 | 0.7 | Yes | \$83.00 |
|  | 36W Hutch Tackboard • 32.60"W x 0.51"D x 15.51"H • GSA - contract pending SIN 711-2 | Lyric Sundew | WCTB36LS | 6 | 0.9 | Yes | \$98.00 |

Storage

File and Pedestal Construction





- All top surfaces and end panels are 1" thick for durability and strength
- Includes Brushed Nickel finish drawer pulls
- Drawer interiors finished in Black
- Case exterior finish matches desk end panels
- Includes face front lock with interchangeable core in lower drawer that secures both the lower and upper drawer
- All file drawers equipped to accommodate hanging folders

Lateral Files







- File drawers accommodate legal, letter and A4 file sizes
- Lateral File drawers glide on full-extension, ball bearing slides
- Interlocking drawer mechanism on Lateral File prevents both drawers from opening at the same time
- All pieces in collection ship keyed alike, additional cores available

2-Drawer and 3-Drawer Mobile Pedestals, 3/4 Pedestal

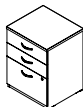
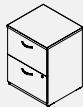
- Face front lock with interchangeable core secures lower and center drawer in 3-Drawer Mobile Pedestal
- All file drawers extend on full-extension, ball bearing slides
- All box drawers utilize 3/4-extension, ball bearing slides
- Dual-wheeled, hooded casters: two swivel, two fixed on mobile pedestals

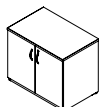
| | Description | Finish | SKU Number | Shpg Wt. (lbs) | Cube (ft.) | UPS/Fed Ex | List Price |
|---|--|-------------------------------|------------------------|----------------|------------|------------|------------|
|  | 3/4 Pedestal <ul style="list-style-type: none"> • Mounts on right or left side of any Desk Shell, Credenza or Return against any full width end panel • 15.51"W x 20.16"D x 20.00"H • GSA - contract pending SIN 711-3 | Hansen Cherry Mocha Cherry | WC24590SU WC12990SU | 47 | 2.5 | Yes | \$374.00 |
|  | 16W 3-Drawer Mobile Pedestal <ul style="list-style-type: none"> • Rolls under desk surface or use free-standing • 15.71"W x 20.16"D x 27.87"H • GSA - contract pending SIN 711-3 | Hansen Cherry Mocha Cherry | WC24553SU WC12953SU | 62 | 3.2 | Yes | \$464.00 |
|  | 16W 2-Drawer Mobile Pedestal <ul style="list-style-type: none"> • Rolls under desk surface or use free-standing • 15.71"W x 20.16"D x 27.87"H • GSA - contract pending SIN 711-3 | Hansen Cherry Mocha Cherry | WC24552SU WC12952SU | 63 | 3.2 | Yes | \$452.00 |
|  | 16W 3-Drawer Pedestal <ul style="list-style-type: none"> • Intended for use beneath desk surface • 15.75"W x 20.35"D x 28.84"H • GSA - contract pending SIN 711-3 | Hansen Cherry Mocha Cherry | WC24555SU WC12955SU | 70 | 3.5 | Yes | \$497.00 |
|  | 16W 2-Drawer Pedestal <ul style="list-style-type: none"> • Intended for use beneath desk surface • 15.75"W x 20.35"D x 28.84"H • GSA - contract pending SIN 711-3 | Hansen Cherry Mocha Cherry | WC24556SU WC12956SU | 70 | 3.5 | Yes | \$481.00 |

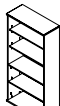
Storage (con't)

| | Description | Finish | SKU Number | Shpg Wt. (lbs) | Cube (ft.) | UPS/ Fed Ex | List Price |
|---|---|-------------------------------|--------------------------|-----------------------------|------------------------------|-------------|------------|
|  | 24W 3-Drawer Pedestal <ul style="list-style-type: none"> Use with finished top or without top under any Desk or Credenza Shell 22.60"W x 20.59"D x 29.84"H GSA - contract pending SIN 711-3 | Hansen Cherry Mocha Cherry | WC24501SU WC12901SU | 97 | 4.7 | Yes | \$621.00 |
|  | 24W 2-Drawer Pedestal <ul style="list-style-type: none"> Use with finished top or without top under any Desk or Credenza Shell 22.60"W x 20.59"D x 29.84"H GSA - contract pending SIN 711-3 | Hansen Cherry Mocha Cherry | WC24502SU WC12902SU | 97 | 4.7 | Yes | \$600.00 |
|  | 24W Pedestal Piler/File <ul style="list-style-type: none"> Use with finished top or without top under any Desk or Credenza Shell Four storage cubbies with two adjustable shelves 22.60"W x 20.59"D x 29.84"H GSA - contract pending SIN 711-3 | Hansen Cherry Mocha Cherry | WC24503SU WC12903SU | 98 | 4.7 | Yes | \$569.00 |
|  | 36W Lateral File <ul style="list-style-type: none"> Accepts 36W Hutch Two adjacent units accept 72W Hutch 35.67"W x 23.35"D x 29.84"H GSA - contract pending SIN 711-3 | Hansen Cherry Mocha Cherry | WC24554CSU WC12954CSU | 127 | 6.1 | No | \$729.00 |
|  | 36W Storage Cabinet <ul style="list-style-type: none"> Accepts 36W Hutch Two adjacent units accept 72W Hutch One adjustable shelf 35.67"W x 23.35"D x 29.84"H GSA - contract pending SIN 711-3 | Hansen Cherry Mocha Cherry | WC24598SU WC12998SU | 111 | 6.1 | Yes | \$595.00 |
|  | 36W Storage Wardrobe Tower <ul style="list-style-type: none"> Full width coat rod One fixed shelf and two adjustable shelves 35.67"W x 23.35"D x 65.98"H GSA - contract pending SIN 711-3 | Hansen Cherry Mocha Cherry | WC24557K WC12957K | Box 1 93 Box 2 105 | Box 1 4.4 Box 2 4.4 | Yes | \$827.00 |
|  | 36W 5-Shelf Bookcase <ul style="list-style-type: none"> 35.71"W x 15.35"D x 72.80"H GSA - contract pending SIN 711-2 | Hansen Cherry Mocha Cherry | WC24414 WC12914 | 116 | 5.0 | Yes | \$390.00 |
|  | 18W 5-Shelf-Bookcase <ul style="list-style-type: none"> Accepts one door from Half-Height Door Kit in lower position, hinged either side 17.83"W x 15.35"D x 72.80"H GSA - contract pending SIN 711-2 | Hansen Cherry Mocha Cherry | WC24412 WC12912 | 89 | 4.0 | Yes | \$287.00 |
|  | Half Height Door Kit <ul style="list-style-type: none"> Includes two non-handed doors 35.47"W x .75"D x 29.25"H GSA - contract pending SIN 711-2 | Hansen Cherry Mocha Cherry | WC24411 WC12911 | 26 | 1.0 | Yes | \$121.00 |

Tables

Work surfaces are constructed of 100% thermally fused laminate with durable edge band to resist scratches and stains

Each foot has levelers to adjust for uneven floor surfaces

All work surfaces and leg end panels are 1" thick

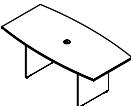
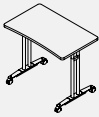
| | Description | Finish | SKU Number | Shpg Wt. (lbs) | Cube (ft.) | UPS/ Fed Ex | List Price |
|---|--|-------------------------------|--------------------------|----------------|------------|-------------|------------|
|  | 42W Round Conference Table <ul style="list-style-type: none"> • Comfortable seating for four people • 41.38"W x 41.38"D x 29.66"H • GSA - contract pending SIN 711-11 | Hansen Cherry Mocha Cherry | 99TB42RHC 99TB42RMR | 80 | 4.5 | Yes | \$459.00 |
|  | 72W x 36W Boat Top Conference Table <ul style="list-style-type: none"> • Comfortable seating for four to six people • 35.98"W x 71.54"D x 28.65"H • GSA - contract pending SIN 711-11 | Hansen Cherry Mocha Cherry | 99TB7236HC 99TB7236MR | 117 | 7.1 | Yes | \$716.00 |
|  | 36W x 22D Adjustable Height Mobile Table <ul style="list-style-type: none"> • Provides a mobile height adjustable work surface • Table adjusts to 8 height settings from 26.63" to 34.63" • Mobile on lockable casters • 35.61"W x 21.97"D x 34.70"H • GSA - contract pending SIN 711-11 | Hansen Cherry Mocha Cherry | WC24482 WC12982 | 58 | 5.7 | Yes | \$440.00 |

Height Adjustable Tables

- ☑ Height ranges from 23" low to 49" high and operates at speed of 1.5 inches per second
- ☑ Use as table, return or bridge
- ☑ Weight capacity up to 200 lbs
- ☑ Four programmable memory presets with a quiet soft touch start and stop
- ☑ Meets ANSI/BIFMA standards for safety and performance in place at time of manufacture
- ☑ Integrates easily with other BBF products
- ☑ Commercial Quality backed by a 5-Year Warranty

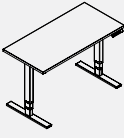
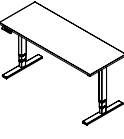
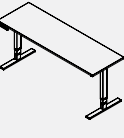
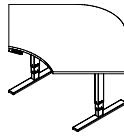
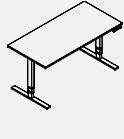
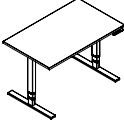
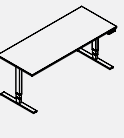
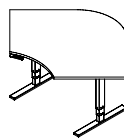
| | Description | Finish | Cool Gray Metallic Base SKU Number | Black Powder Coat Base SKU Number | Shpg Wt. (lbs) | Cube (ft.) | UPS/ Fed Ex | List Price |
|---|--|-------------------------------|------------------------------------|-----------------------------------|----------------------------|------------------------------|-------------|------------|
|  | 48W x 24D Height Adjustable Table Kit • GSA - contract pending SIN 711-11 | Hansen Cherry Mocha Cherry | HAT4824HCK HAT4824MRK | HAT4824HCBK HAT4824MRBK | Box 1 37 Box 2 70 | Box 1 2.5 Box 2 2.4 | Yes | \$1,610.00 |
|  | 60W x 24D Height Adjustable Table Kit • GSA - contract pending SIN 711-11 • Special Order—call for details | Hansen Cherry Mocha Cherry | HAT6024HCK HAT6024MRK | HAT6024HCBK HAT6024MRBK | Box 1 37 Box 2 70 | Box 1 2.5 Box 2 2.4 | Yes | \$1,638.00 |
|  | 72W x 24D Height Adjustable Table Kit • GSA - contract pending SIN 711-11 • Special Order—call for details | Hansen Cherry Mocha Cherry | HAT7224HCK HAT7224MRK | HAT7224HCBK HAT7224MRBK | Box 1 45 Box 2 71 | Box 1 3.1 Box 2 2.4 | Yes | \$1,707.00 |
|  | 48 x 48 x 24 Height Adjustable Table Kit • GSA - contract pending SIN 711-11 • Special Order—call for details | Hansen Cherry Mocha Cherry | HAT484824HCK HAT484824MRK | HAT484824HCBK HAT484824MRBK | Box 1 56 Box 2 71 | Box 1 3.7 Box 2 2.4 | Yes | \$1,771.00 |
|  | 48W x 30D Height Adjustable Table Kit • GSA - contract pending SIN 711-11 | Hansen Cherry Mocha Cherry | HAT4830HCK HAT4830MRK | HAT4830HCBK HAT4830MRBK | Box 1 45 Box 2 71 | Box 1 3.1 Box 2 2.4 | Yes | \$1,625.00 |
|  | 60W x 30D Height Adjustable Table Kit • GSA - contract pending SIN 711-11 | Hansen Cherry Mocha Cherry | HAT6030HCK HAT6030MRK | HAT6030HCBK HAT6030MRBK | Box 1 56 Box 2 71 | Box 1 3.7 Box 2 2.4 | Yes | \$1,652.00 |
|  | 72W x 30D Height Adjustable Table Kit • GSA - contract pending SIN 711-11 | Hansen Cherry Mocha Cherry | HAT7230HCK HAT7230MRK | HAT7230HCBK HAT7230MRBK | Box 1 66 Box 2 71 | Box 1 4.4 Box 2 2.4 | Yes | \$1,737.00 |
|  | 48 x 48 x 30 Height Adjustable Table Kit • GSA - contract pending SIN 711-11 • Special Order—call for details | Hansen Cherry Mocha Cherry | HAT484830HCK HAT484830MRK | HAT484830HCBK HAT484830MRBK | Box 1 66 Box 2 71 | Box 1 4.4 Box 2 2.4 | Yes | \$1,807.00 |

GSA Awarded Terms & Conditions

Bush Industries, Inc.

Federal Supply Service-
Authorized Federal Supply Schedule Price List
Online access to contract ordering information, terms and conditions, up-to-date pricing, and the option to create an electronic delivery order are available through GSA Advantage!, a menu-driven database system. The Internet address for GSA Advantage! is: GSAAdvantage.gov
Worldwide Federal Supply Schedule Contract for Schedule 71, Part 1- Office Furniture
FSC Groups 7105, 7110, 7125, 7195
Contract No. GS-28F-0040V

Contract Period: July 24, 2009, through July 23, 2019
Contractor: Bush Industries

Federal Government Sales
One Mason Drive, PO Box 460
Jamestown, NY 14702-0460
Phone: 1-888-339-2202
Fax: 1-716-665-1111
Email Address: GSAServices@BushIndustries.com
<http://www.bbffits.com/Markets/GSA.aspx>
Business Size: Small
For more information on ordering from Federal Supply Schedules click on the FSS Schedules button at fss.gsa.gov.

1. a. The following Special Item Numbers (SIN's) are hereby awarded as a part of this contract:
 - SIN 711-2 Worksurfaces, Workstations, Computer Furniture and Accessories
 - SIN 711-3 Filing and Storage Cabinets, Shelves, Mobile Carts, Dollies, Racks, and Accessories
 - SIN 711-11 Tables and Accessories
 - SIN 711-2 Executive Office Furniture
 - SIN 711-18 Multi Purpose Seating
 - SIN 711-19 Stacking Chairs
- b. N/A. For all pricing refer to: Schedule GS-28F-0040V at www.gsaadvantage.gov
- c. Hourly rates N/A

2. Maximum Order \$500,000 Net
3. Minimum Order \$1
4. Geographic coverage: Shipped to addresses with the contiguous US only, no shipments to PO boxes, APO/FPO addresses, Alaska or Hawaii
5. Points of Production: Within United States
6. Discount: 58.21% from BBF (Bush Business Furniture) GSA Pricelist updated March 2014. All commercial product will be shipped with Prepaid Freight pricing for shipments to contiguous US destinations.
7. Quantity discounts per shipment/ location:
\$25,001 – \$125,786 List; 60.25%
\$125,787 – \$1,368,738 List 63.48%
Contact BBF GSA Support; 1-888-339-2202 for more information
8. Prompt Payment Terms: Net 30
9. a. Government purchase cards accepted at or below the micro-purchase threshold.
b. Government purchase cards are accepted above the micro-purchase threshold.
10. Foreign items: BBF Federal Government office furniture schedule only offers items which are made in TAA-Compliant countries.
11. a. Delivery Time: 30 days ARO (Maximum 30 days – most orders ship within 3–5 days, assembled orders deliver within 20 days from shipment. Delivery times vary depending on base security clearance).
b. Expedited Delivery: Contact BBF GSA Support; 1-888-339-2202 for availability and expedited freight rate.
c. Overnight and 2-day delivery: Contact BBF GSA Support; 1-888-339-2202 for availability and expedited freight rate.
d. Urgent Requirements: Contact BBF GSA Support; 1-888-339-2202 with details.



Schedule

Contract GS-28F-0040V

12. a. FOB points: FOB Destination
- b. FOB Terms: The following FOB terms apply to all orders:
 - The above charges are limited to deliveries to a commercial delivery dock. If no dock is available or additional services are required, additional charges are applicable.
13. a. Ordering address: Same as Contractor
- b. Ordering Procedures: Orders may be placed via:
 - GSA Advantage! www.gsaadvantage.gov
 - Fax: 1-716-665-1111
 - Email: GSAServices@BushIndustries.com
 - U.S. Postal: Bush Industries
One Mason Drive
Jamestown, NY 14702
14. Payment address: Same as Contractor
15. a. Warranty: The following warranty applies as shown by product line:
 - 10-year limited warranty: Series A, Series C, Sector, Aspen Conference Tables and Accessories
 - Limited lifetime warranty: Momentum, Milano2, Realize, Quantum and Synchronize Metal Filing
- b. Cancellation Policy: No cost prior to production. After production has begun, only actual costs incurred that the contractor can demonstrate will be charged to the Government if the product cannot be sold in a reasonable length of time (6 months).
- c. Return Policy/Restocking Fee: The Government customer must obtain written authorization from Bush Industries prior to returning any products and they will also be required to pay all outbound/inbound freight charges. A restocking fee of 20% will apply to all returned products.
16. Export packing charges: N/A
17. Terms and conditions of Government purchase card: Government purchase card accepted for all orders.
18. Terms and conditions of rental, maintenance, and repair: N/A
19. Terms and conditions of installation: Call for details
20. Terms and conditions of repair parts: Products are guaranteed to be free of defects for the warranty period (warranty period is based on brand – refer to above or warranty card in product carton). This warranty is expressly limited to replacement of furniture parts and components. For all issues related to post sale service such as parts replacement, warranty claims, assembly tips, defective product disposition, call Consumer Service at 800-950-4782. No credit will be issued for defective product without prior authorization.
 - a. Terms and conditions of any other services: Call for details
21. List of service and distribution points: Erie, PA 16509 & McCarran, NV 89434
22. List of participating dealers: Call for details
23. Preventive maintenance: N/A
24. a. Special attributes: Bush Industries' manufacturing facility is currently on course to meet BIFMA Level certification. Visit <http://www.bbffits.com/AboutBBF/SustainabilityMaterialRecovery.aspx> for more information regarding Bush Industries commitment to: CARB compliance, EPP Downstream Program (Composite Panel Association), Energy Consumption, Landfill Reduction, Corporate Recycling, and Sustainability.
 - b. Section 508 Compliance: N/A
25. DUNS number: 00211961
26. CCR Registration: Bush Industries is registered DUNS – 00211961 CAGE – 3CA68



One Mason Drive
PO BOX 460
Jamestown, NY 14702-0460
800.964.1638
Fax: 716.665.2074
www.bbffits.mobi

To reorder this catalog visit
www.bushliterature.com
BBFPRICER0515
Printed 4/2015